



**TRACKED EXCAVATOR | 245XR**

Engine Power: 129kW (173 hp) | Operating weight: 25,284-28,009kg | Bucket capacity: 0.35 – 1.25 m<sup>3</sup>



# MINIMUM SWING. MAXIMUM SPACE.

The new JCB 245XR is the latest addition to our highly acclaimed X SERIES. Our engineering teams have obsessed over every detail of this new world-class excavator and produced a machine that boasts a reduced slewing radius, without any compromise on cab space or performance.



## MINIMUM SWING.

At just 1,720mm, the 245XR has a 40% shorter tailswing than the conventional 220X making it ideal for contractors working in confined urban sites.



## MAXIMUM SPACE.

Despite having reduced tail swing, the new 245XR still boasts one of the biggest, most comfortable, quiet and easy to operate cabs on the market.

## EXTREME STRENGTH.

It's taken extensive hydraulic, electrical and structural development and testing to build you a machine that doesn't just look strong, but is strong.



## EXTRAORDINARY ATTENTION TO DETAIL.

The 245XR follows the same high quality X Series design ethos and utilises cutting-edge production facilities to bring you not just great excavators, but exceptional ones.

## EXCELLENT CONTROL.

Proven Japanese components deliver precise, efficient control. Customisable electro-proportional controls allow operators to set their preference of speed and control of attachments.

# SPECIFICATION 245XR

## STATIC DIMENSIONS

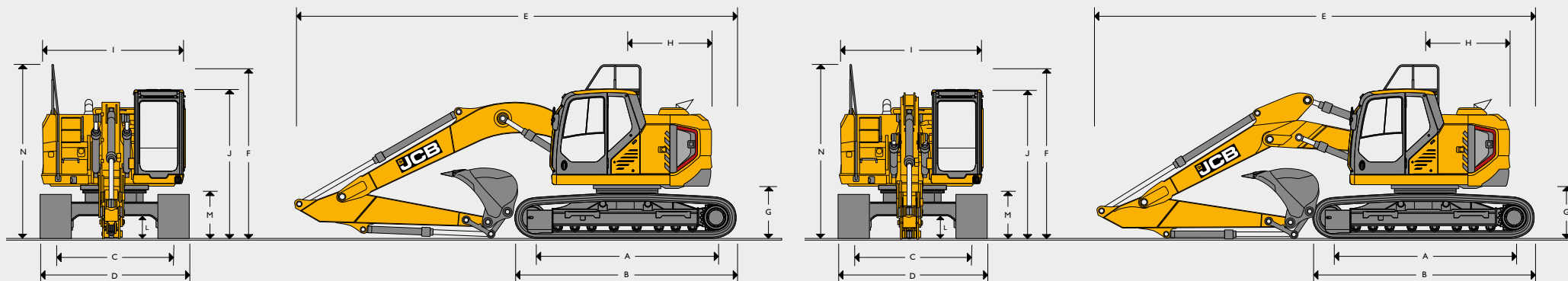

## STATIC DIMENSIONS

Model		245 XR	
A	Track length on ground	mm	3660
B	Undercarriage overall length	mm	4469
C	Track Gauge	mm	2390
D	Width over tracks (600mm track shoes)	mm	2990
D	Width over tracks (700mm track shoes)	mm	3090
D	Width over tracks (800mm track shoes)	mm	3190
D	Width over tracks (900mm track shoes)	mm	3290
G	Counterweight clearance	mm	1069
H	Tail length	mm	1720
H	Tail swing radius	mm	1720
I	Overall width of superstructure	mm	2889
I	Overall width of superstructure (with Cab Grab Handle)	mm	2912
J	Height over cab	mm	3031
L	Ground clearance	mm	486
M	Track height	mm	899
N	Overall height of upper structure with std. handrail	mm	3537
N	Overall height to folded handrail	mm	3092
<b>Mono</b>			
<b>Dipper lengths</b>		<b>2.4m</b>	<b>3.0m</b>
E	Transport length	mm	9084
F	Transport height with Std Handrail	mm	3537
F	Transport height with Folding Handrail	mm	3127
<b>T.A.B</b>			
<b>Dipper lengths</b>		<b>2.4m</b>	<b>3.0m</b>
E	Transport length	mm	9107
F	Transport height with Std Handrail	mm	3537
F	Transport height with Folding Handrail	mm	3152

## SPECIFICATION 245XR

ENGINE	
Model	JCB DieselMAX 448 Stage V
Type	4 stroke, 4 cylinder in-line, direct injection, turbocharged diesel
Rated Power	129kW (173 hp)
Piston Displacement	4.8 litres
Air Filtration	dry element with in cab warning indicator
Starting System	24 volt
Batteries	2 x 12 volt
Alternator	28 volt - 100 ampere
Maximum Torque	690 Nm @ 1500 rpm
Bore & Stroke	106 x 135mm

SWING SYSTEM	
Swing motor	Axial Piston type
Swing Brake	Hydraulic braking plus automatic spring applied disc type parking brake
Swing torque	81.5 kNm
Swing speed	10.4 rpm
Swing gear	Large diameter, internally toothed fully sealed grease bath lubricated.
Swing lock	switchable brake in cab

TRACK DRIVE	
Type	Fully hydrostatic, two speed with autoshift
Travel motors	Variable swash axial piston type, fully guarded within undercarriage frame
Final drive	Planetary reduction, bolt-on sprockets
Service brake	Hydraulic counter balance valve
Park brake	Disc type, spring applied, automatic hydraulic release
Gradeability	70% (35°) continuous
Travel speed	High - 5.7 km/h Low - 3.2 km/h
Tractive effort kN	207.5 kNm

SERVICE CAPACITIES			
Fuel tank	Litres		310
Engine coolant	Litres		27
Engine oil	Litres		20.4
Swing reduction gear	Litres		11
Track reduction gear (each side)	Litres		3.5
Hydraulic system	Litres		250
Hydraulic tank	Litres		120
DEF fluid capacity (if applic.)	Litres		31.4

HYDRAULIC SYSTEM	
<b>Pumps</b>	
Main pumps	2 variable displacement axial piston type
Maximum flow	2 x 228 l/min
Servo pump	Gear type
Servo pump maximum flow	16 l/min
<b>Control valve</b>	
A combined four and five spool control valve with auxiliary service spool as standard	
<b>Relief valve settings</b>	
Boom/Arm/Bucket	343 bar
With power boost	373 bar
Swing circuit	280 bar
Travel circuit	343 bar
Pilot control	39 bar
<b>Filtration</b>	
In tank	105 micron, suction strainer
Main return line	10 micron, glass fibre element
Pilot line	10 micron, glass fibre element
Hydraulic hammer return	10 micron, reinforced microform element

## OPTIONAL BLADE

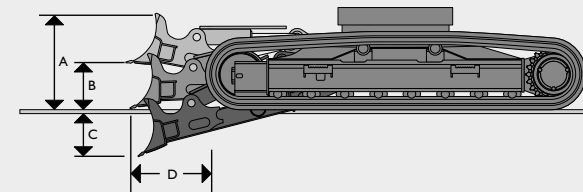

A	Blade Height	mm	600
B	Blade lift above ground	mm	500
C	Blade cut below ground	mm	360
D	Blade forward of track	mm	567
	Dozer width - (600mm)	mm	2990
	Dozer width - (700mm)	mm	3110

Additional machine weight with blade		
600mm tracks	kg	1588
700mm tracks	kg	1602

SOUND LEVEL	
Sound level in cab according to ISO 6396	69 dB LpA
External sound level according to ISO 6395 and EU Directive 2000/14/EC	102 dB LwA

# SPECIFICATION 245XR

UNDERCARRIAGE				
Carriage options	LC - Long Carriage			
Construction	Fully welded 'X' frame type with central bellyguarding and sloping side members with dirt relief holes under top rollers			
Recovery point	Front and rear			
Upper & lower rollers	Heat treated sealed and lubricated			
Track adjustment	Grease cylinder type			
Track idler	Sealed and lubricated, with spring cushioned recoil			
Track type	Sealed and lubricated			
Track shoes (mm)	600mm	700mm	800mm	900mm
	LC			
No. of upper rollers	2			
No. of lower rollers	8			
No. of track guides (option)	2 or Full			
No. of track shoes	49			

BUCKET AND ARM COMBINATION													245XR	
Bucket options		GP Buckets							HD Buckets					
Bucket width	mm	610	762	915	1067	1219	1372	1524	750	900	1100	1200	1350	1500
Bucket capacity	m <sup>3</sup>	0.35	0.51	0.66	0.81	0.96	1.11	1.27	0.52	0.66	0.81	0.96	1.11	1.25
Bucket weight	kg	479	531	589	644	715	772	842	610	691	752	813	894	955
<b>245XR LC Mono</b>														
2.4m Quickhitch (No Quickhitch)		☐ (☐)	☐ (☐)	☐ (☐)	☐ (☐)	☐ (☐)	☐ (☐)	☐ (☐)	☐ (☐)	☐ (☐)	☐ (☐)	☐ (☐)	☐ (☐)	☐ (☐)
3.0m Quickhitch (No Quickhitch)		☐ (☐)	☐ (☐)	☐ (☐)	☐ (☐)	☐ (☐)	☐ (☐)	■ (☐)	☐ (☐)	☐ (☐)	☐ (☐)	☐ (☐)	■ (☐)	■ (☐)
<b>245XR LCD Mono</b>														
2.4m Quickhitch (No Quickhitch)		☐ (☐)	☐ (☐)	☐ (☐)	☐ (☐)	☐ (☐)	☐ (☐)	☐ (☐)	☐ (☐)	☐ (☐)	☐ (☐)	☐ (☐)	☐ (☐)	☐ (☐)
3.0m Quickhitch (No Quickhitch)		☐ (☐)	☐ (☐)	☐ (☐)	☐ (☐)	☐ (☐)	☐ (☐)	■ (☐)	☐ (☐)	☐ (☐)	☐ (☐)	☐ (☐)	■ (☐)	■ (☐)
<b>245XR LC TAB</b>														
2.4m Quickhitch (No Quickhitch)		☐ (☐)	☐ (☐)	☐ (☐)	☐ (☐)	☐ (☐)	☐ (☐)	■ (☐)	☐ (☐)	☐ (☐)	☐ (☐)	☐ (☐)	☐ (☐)	■ (☐)
3.0m Quickhitch (No Quickhitch)		☐ (☐)	☐ (☐)	☐ (☐)	☐ (☐)	☐ (☐)	☐ (☐)	■ (☐)	☐ (☐)	☐ (☐)	☐ (☐)	☐ (☐)	■ (☐)	■ (☐)
<b>245XR LCD TAB</b>														
2.4m Quickhitch (No Quickhitch)		☐ (☐)	☐ (☐)	☐ (☐)	☐ (☐)	☐ (☐)	☐ (☐)	☐ (☐)	☐ (☐)	☐ (☐)	☐ (☐)	☐ (☐)	☐ (☐)	☐ (☐)
3.0m Quickhitch (No Quickhitch)		☐ (☐)	☐ (☐)	☐ (☐)	☐ (☐)	☐ (☐)	☐ (☐)	■ (☐)	☐ (☐)	☐ (☐)	☐ (☐)	☐ (☐)	■ (☐)	■ (☐)

- ☐ = Suitable for general excavating material weight up to 2000 kg/m<sup>3</sup>.
- = Suitable for grading and loading material weight up to 1600 kg/m<sup>3</sup>.
- = Suitable for light excavating material weight up to 1200 kg/m<sup>3</sup>.
- X = Not recommended.

These recommendations are given as a guide based on typical operating conditions.  
Please contact your distributor for the correct selection of buckets and attachments to suit the application.

## SPECIFICATION 245XR

### WEIGHTS AND GROUND BEARING PRESSURES

Figures include: 1.1m<sup>3</sup> bucket 772kg, operator 75kg, full fuel tank and 2.4m dipper

		Track shoe options			
		600mm STD	700mm STD	800mm STD	900mm STD
<b>245XR LC MonoBoom</b>					
Machine weight	kg	25023	25292	25579	25848
Ground bearing pressure	kg/cm <sup>2</sup>	0.50	0.43	0.38	0.34

#### 245XR LC MonoBoom Dozer

Machine weight	kg	26632	26915	-	-
Ground bearing pressure	kg/cm <sup>2</sup>	0.53	0.46	-	-

		600mm HD	700mm HD	800mm HD	900mm HD
--	--	----------	----------	----------	----------

#### 245XR LC MonoBoom

Machine weight	kg	25284	25603	25941	26261
Ground bearing pressure	kg/cm <sup>2</sup>	0.50	0.44	0.39	0.35

#### 245XR LC MonoBoom Dozer

Machine weight	kg	26893	27226	-	-
Ground bearing pressure	kg/cm <sup>2</sup>	0.54	0.47	-	-

Figures include: 1.1m<sup>3</sup> bucket 772kg, operator 75kg, full fuel tank and 3.0m dipper

		600mm STD	700mm STD	800mm STD	900mm STD
<b>245XR LC MonoBoom</b>					
Machine weight	kg	25095	25365	25652	25920
Ground bearing pressure	kg/cm <sup>2</sup>	0.50	0.43	0.38	0.34

#### 245XR LC MonoBoom Dozer

Machine weight	kg	26704	26987	-	-
Ground bearing pressure	kg/cm <sup>2</sup>	0.53	0.46	-	-

		600mm HD	700mm HD	800mm HD	900mm HD
--	--	----------	----------	----------	----------

#### 245XR LC MonoBoom

Machine weight	kg	25356	25676	26014	26333
Ground bearing pressure	kg/cm <sup>2</sup>	0.51	0.44	0.39	0.35

#### 245XR LC MonoBoom Dozer

Machine weight	kg	26965	27299	-	-
Ground bearing pressure	kg/cm <sup>2</sup>	0.54	0.47	-	-

### WEIGHTS AND GROUND BEARING PRESSURES

Figures include: 1.1m<sup>3</sup> bucket 772kg, operator 75kg, full fuel tank and 2.4m dipper

		Track shoe options			
		600mm STD	700mm STD	800mm STD	900mm STD
<b>245XR LC T.A.B.</b>					
Machine weight	kg	25733	26003	26290	26558
Ground bearing pressure	kg/cm <sup>2</sup>	0.51	0.44	0.39	0.35

#### 245XR LC T.A.B. Dozer

Machine weight	kg	27342	27626	-	-
Ground bearing pressure	kg/cm <sup>2</sup>	0.55	0.47	-	-

		600mm HD	700mm HD	800mm HD	900mm HD
--	--	----------	----------	----------	----------

#### 245XR LC T.A.B.

Machine weight	kg	25994	26314	26652	26971
Ground bearing pressure	kg/cm <sup>2</sup>	0.52	0.45	0.40	0.36

#### 245XR LC T.A.B. Dozer

Machine weight	kg	27603	27937	-	-
Ground bearing pressure	kg/cm <sup>2</sup>	0.55	0.48	-	-

Figures include: 1.1m<sup>3</sup> bucket 772kg, operator 75kg, full fuel tank and 3.0m dipper

		600mm STD	700mm STD	800mm STD	900mm STD
<b>245XR LC T.A.B.</b>					
Machine weight	kg	25806	26075	26362	26631
Ground bearing pressure	kg/cm <sup>2</sup>	0.51	0.45	0.39	0.35

#### 245XR LC T.A.B. Dozer

Machine weight	kg	27414	27698	-	-
Ground bearing pressure	kg/cm <sup>2</sup>	0.55	0.47	-	-

		600mm HD	700mm HD	800mm HD	900mm HD
--	--	----------	----------	----------	----------

#### 245XR LC T.A.B.

Machine weight	kg	26067	26386	26724	27044
Ground bearing pressure	kg/cm <sup>2</sup>	0.52	0.45	0.40	0.36

#### 245XR LC T.A.B. Dozer

Machine weight	kg	27675	28009	-	-
Ground bearing pressure	kg/cm <sup>2</sup>	0.55	0.48	-	-

# SPECIFICATION 245XR

WORKING RANGE		245XR LC MONO	
Dipper length:		2.4m	3.0m
A	Maximum digging reach	mm 9423	9952
B	Maximum digging reach (on ground)	mm 9244	9784
C	Maximum digging depth	mm 6029	6627
D	Maximum digging height	mm 10354	10708
E	Maximum dumping height	mm 7593	7951
F	Maximum vertical wall cut depth	mm 5459	6011
G	Minimum swing radius	mm 2566	2345
	Bucket rotation	degrees 183	183
	Maximum dipper tearout	kN 125	103
	Maximum bucket tearout	kN 148	148
Bucket used for calculations		980/B0090	

WORKING RANGE		245XR LC TAB	
Dipper length:		2.4m	3.0m
A	Maximum digging reach	mm 9472	10009
B	Maximum digging reach (on ground)	mm 9295	9841
C	Maximum digging depth	mm 5619	6200
D	Maximum digging height	mm 10615	11013
E	Maximum dumping height	mm 7827	8228
F	Maximum vertical wall cut depth	mm 4749	5326
G	Minimum swing radius	mm 2500	2206
	Bucket rotation	degrees 183	183
	Maximum dipper tearout	kN 125	103
	Maximum bucket tearout	kN 148	148
Bucket used for calculations		980/B0090	

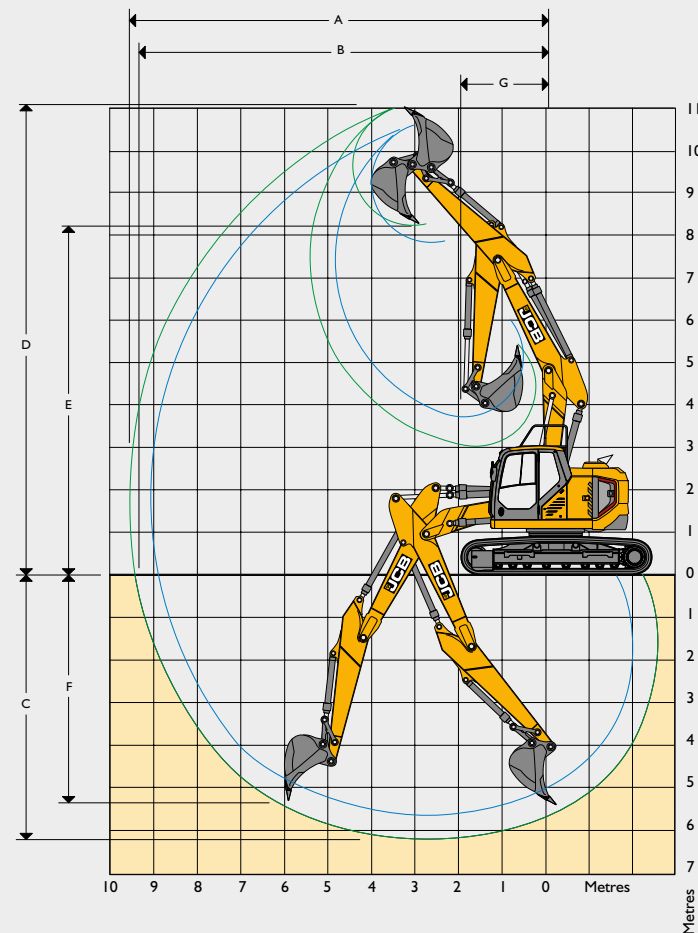
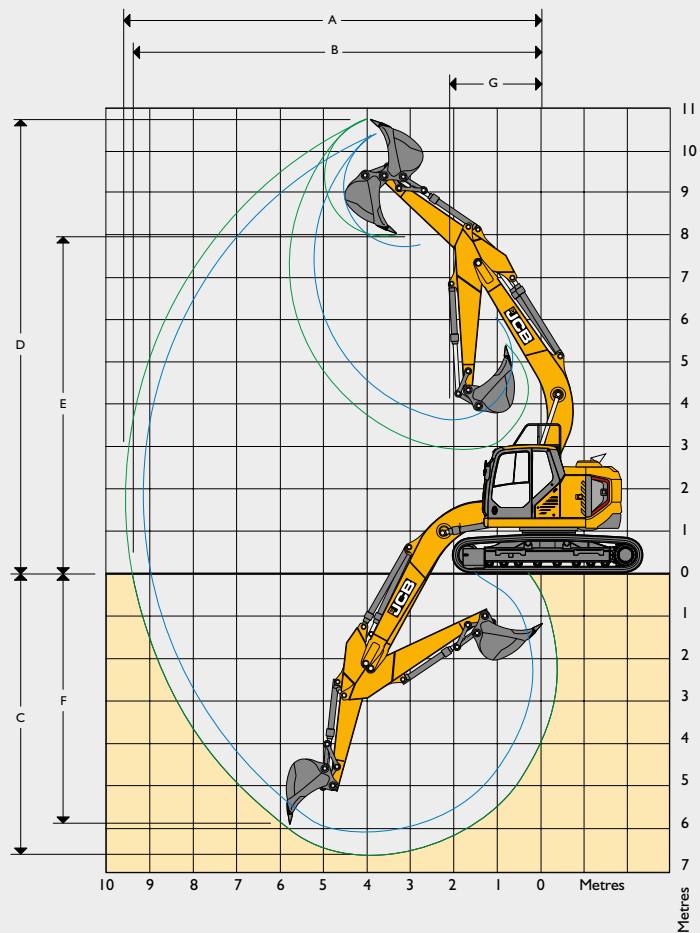













# SPECIFICATION 245XR

## STANDARD/OPTIONAL EQUIPMENT

ENGINE		CAB & INTERIOR		HYDRAULIC SYSTEM	
JCB, Stage V compliant, SCR, water cooled diesel turbocharged after cooled electronic 4 cylinder 4.8 litre engine	•	Sound-insulated and 4 dual shock mounted cab	•	Boom and arm flow regeneration	•
One touch idle	•	Mechanical suspension seat	•	One touch power boost	•
Auto-idle function	•	Heater	•	Boom/slew priority control	•
Automatic engine shutdown	•	Opening front window and removable lower front window	•	Cushion control	•
Fan guard	•	Upper door sliding glass in 2 directions	•	Cylinder cushioning and contamination seals	•
Heavy-duty batteries	•	Upper windscreen wiper	•	2 speed track motors	•
Fuel filter with sedimenter	•	4 button joysticks	•	Oil cooler	•
Electronic engine control	•	Travel pedals and T handle levers	•	10 attachment settings through the display	•
Fuel cooler	•	2 foot rests	•	High, merged, medium and low flow options (shut off taps as standard)	+
Refuelling pump with inline filter	+	Immobiliser	•	Advanced tool select to control flow and pressure	+
Fuel filter for refuelling pump	•	Loudspeakers and connection for radio	•	Proportional control joystick sliders with electronic foot pedal	+
<b>SAFETY</b>		Standard cab filtration	•	Bio oil	+
Side guard rails on upper structure and steps	•	Electric dual tone horn	•	Panolin oil	+
Twin camera	•	Interior cab light	•	Quickhitch pipework	+
Battery isolator	•	3 x 12v sockets	•	Hydraulic quickhitch	+
Key	•	7" colour monitor	•	ISO/SAE change over	+
Lockable fuel tank cap	•	Retractable 2" seat belt	•	SAE to BSP converters on high flow auxiliary pipework	+
Lockable hydraulic tank cap	•	Fixed roof glass	•	Quick release couplings	+
Work lights (2 revolving frame, 2 boom mounted)	•	Roof blind	•	Hose burst check valves (boom, arm & bucket)	+
Roll over protective structure (ROPS)	•	Cool box	•	Auxiliary vent to tank	+
Travel alarm	•	Cup holder	•	Attachment case drain	+
Additional light options (Levels 2 & 3 available in halogen or LED)	+	Climate control	•	Steelwrist ready	+
White noise alarm	+	Rear window blind	+	<b>DIG END</b>	
Green beacon linked to seat belt	+	3" seat belt	+	Grouped greasing	•
FOPS Level II guard top and front	+	2" hi vis seat belt	+	Dippers 2.4m, 3.0m	+
Fire extinguisher (1kg powder)	+	3" hi vis seat belt	+	HD dipper 2.4m, 3.0m	+
Vandal guards	+	Front blind	+	Lifting hook tipping link	+
Chevron counterweight	+	Side window blind	+	Lifting shackle tipping link	+
Rotating roof beacon	+	Opening roof hatch	+	Bucket ram guard	+
2 x counterweight beacons	+	Bluetooth radio (linked to pod controls and screen)	+	Triple articulated boom	+
360 degree camera	+	Carbon air filter	+	Guards for boom mounted lights	+
Folding handrails	+	Deluxe seat: Heated, adjustable air suspension seat with adjustable headrest mechanical lumbar support	+	<b>OTHER</b>	
Full upper surrounding handrails	+	Super deluxe seat: Heated and air ventilation, adjustable air suspension seat with adjustable head rest and electric lumbar support	+	Hour meter	•
Arm limiter	+	Rain guard visor	+	Wide core radiators	•
		Dual front wiper	+	LiveLink telematics	•
		<b>UNDERCARRIAGE</b>		HD slew bearing seal	•
		Greased and sealed track links	•	10mm heavy-duty plates for upper and lower structure	+
		Twin track guards	•	Pleated radiator flyscreen	+
		Full length track guards	+	Work light guards	+
		500, 600, 700, 800, 900 mm triple grouser shoe	+	Service bay and access lighting	+
		Dozer for LC carriage 600mm or 700mm tracks	+	GPS ready	+
				<b>STANDARD</b>	•
				<b>OPTIONAL</b>	+















**LIFT CAPACITIES - DIPPER LENGTH 2.4M, MONOBOOM, TRACKSHOES: 600HD, NO BUCKET** **245XR LC MONO**

Reach	1.5m		3m		4.5m		6m		7.5m		Capacity at Max. Reach		
													mm
Load Point Height	kg	kg	kg	kg	kg	kg	kg	kg	kg	kg	kg	kg	mm
7.5m					6828*	6828*					5081*	5081*	5585
6m					7081*	7081*	6390*	5277			4640*	4240	6811
4.5m			11686*	11686*	8237*	7968	6791*	5102	4890*	3556	4530*	3518	7546
3m					9833*	7324	7448*	4834	5626	3465	4628*	3170	7929
1.5m					10950*	6809	7668	4582	5500	3350	4927*	3044	8013
0m					11041*	6584	7486	4421	5417	3274	5122	3106	7808
-1.5m			10237*	10237*	10269*	6558	7433	4376			5642	3404	7289
-3m			10987*	10987*	8598*	6676	6322*	4468			5634*	4147	6376
-4.5m					5121*	5121*					4477*	4477*	4850

**LIFT CAPACITIES - DIPPER LENGTH 3.0M, MONOBOOM, TRACKSHOES: 600HD, NO BUCKET** **245XR LC MONO**

Reach	1.5m		3m		4.5m		6m		7.5m		Capacity at Max. Reach		
													mm
Load Point Height	kg	kg	kg	kg	kg	kg	kg	kg	kg	kg	kg	kg	mm
7.5m							4288*	4288*			3298*	3298*	6327
6m					5780*	5780*	5633*	5392			3062*	3062*	7429
4.5m			8436*	8436*	7452*	7452*	6308*	5198	5109*	3622	3007*	3007*	8107
3m			10220*	10220*	9126*	7537	7050*	4912	5666	3497	3075*	2872	8464
1.5m					10544*	6938	7725	4626	5512	3356	3268*	2758	8543
0m			5879*	5879*	11059*	6602	7492	4420	5393	3248	3624*	2798	8351
-1.5m	6190*	6190*	9928*	9928*	10659*	6497	7387	4328	5350	3208	4266*	3019	7868
-3m	10456*	10456*	12710*	12710*	9390*	6556	7012*	4357			5482*	3551	7034
-4.5m			9004*	9004*	6835*	6786					4926*	4900	5691

**LIFT CAPACITIES - DIPPER LENGTH 2.4M, MONOBOOM, TRACKSHOES: 600HD, NO BUCKET** **245XR LCD MONO**



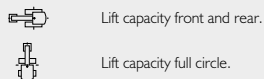









Reach	1.5m		3m		4.5m		6m		7.5m		Capacity at Max. Reach		
													mm
Load Point Height	kg	kg	kg	kg	kg	kg	kg	kg	kg	kg	kg	kg	mm
7.5m					6828*	6828*					5081*	5081*	5585
6m					7081*	7081*	6390*	5605			4640*	4520	6811
4.5m			11686*	11686*	8237*	8237*	6791*	5429	4890*	3806	4530*	3765	7546
3m					9833*	7804	7448*	5162	5729	3713	4628*	3403	7929
1.5m					10950*	7290	7809	4910	5604	3599	4927*	3274	8013
0m					11041*	7065	7627	4749	5521	3524	5221	3343	7808
-1.5m			10237*	10237*	10269*	7039	7574	4703			5750	3662	7289
-3m			10987*	10987*	8598*	7157	6322*	4796			5634*	4450	6376
-4.5m					5121*	5121*					4477*	4477*	4850



- Notes:**
- Lifting capacities are based on ISO 10567, that is: 75% of minimum tipping load or 87% of hydraulic lift capacity, whichever is the less. Lifting capacities marked\* are based on hydraulic capacity.
  - Lift capacities assume that the machine is on firm, level ground.
  - Lift capacities may be limited by local regulations. Please refer to your dealer.













**LIFT CAPACITIES - DIPPER LENGTH 3.0M, MONOBOOM, TRACKSHOES: 600HD, NO BUCKET**

**245XR LCD MONO**

Reach	1.5m		3m		4.5m		6m		7.5m		Capacity at Max. Reach		
													mm
Load Point Height	kg	kg	kg	kg	kg	kg	kg	kg	kg	kg	kg	kg	mm
7.5m							4288*	4288*			3298*	3298*	6327
6m					5780*	5780*	5633*	5633*			3062*	3062*	7429
4.5m			8436*	8436*	7452*	7452*	6308*	5526	5109*	3872	3007*	3007*	8107
3m			10220*	10220*	9126*	8018	7050*	5240	5770	3746	3075*	3075*	8464
1.5m					10544*	7418	7747*	4954	5616	3605	3268*	2972	8543
0m			5879*	5879*	11059*	7082	7634	4748	5497	3496	3624*	3016	8351
-1.5m	6190*	6190*	9928*	9928*	10659*	6978	7528	4656	5453	3457	4266*	3254	7868
-3m	10456*	10456*	12710*	12710*	9390*	7036	7012*	4684			5482*	3820	7034
-4.5m			9004*	9004*	6835*	6835*					4926*	4926*	5691













**LIFT CAPACITIES - DIPPER LENGTH 2.4M, MONOBOOM, TRACKSHOES: 700HD, NO BUCKET**

**245XR LC MONO**

Reach	1.5m		3m		4.5m		6m		7.5m		Capacity at Max. Reach		
													mm
Load Point Height	kg	kg	kg	kg	kg	kg	kg	kg	kg	kg	kg	kg	mm
7.5m					6828*	6828*					5081*	5081*	5585
6m					7081*	7081*	6390*	5342			4640*	4296	6811
4.5m			11686*	11686*	8237*	8063	6791*	5167	4890*	3606	4530*	3567	7546
3m					9833*	7419	7448*	4900	5705	3514	4628*	3217	7929
1.5m					10950*	6905	7776	4648	5580	3400	4927*	3089	8013
0m					11041*	6680	7594	4486	5497	3324	5198	3153	7808
-1.5m			10237*	10237*	10269*	6653	7542	4440			5725	3455	7289
-3m			10987*	10987*	8598*	6772	6322*	4533			5634*	4207	6376
-4.5m					5121*	5121*					4477*	4477*	4850

**LIFT CAPACITIES - DIPPER LENGTH 3.0M, MONOBOOM, TRACKSHOES: 700HD, NO BUCKET**

**245XR LC MONO**

Reach	1.5m		3m		4.5m		6m		7.5m		Capacity at Max. Reach		
													mm
Load Point Height	kg	kg	kg	kg	kg	kg	kg	kg	kg	kg	kg	kg	mm
7.5m							4288*	4288*			3298*	3298*	6327
6m					5780*	5780*	5633*	5457			3062*	3062*	7429
4.5m			8436*	8436*	7452*	7452*	6308*	5263	5109*	3672	3007*	3007*	8107
3m			10220*	10220*	9126*	7632	7050*	4977	5746	3547	3075*	2914	8464
1.5m					10544*	7033	7747*	4691	5592	3406	3268*	2801	8543
0m			5879*	5879*	11059*	6697	7600	4486	5473	3298	3624*	2841	8351
-1.5m	6190*	6190*	9928*	9928*	10659*	6592	7496	4393	5429	3257	4266*	3065	7868
-3m	10456*	10456*	12710*	12710*	9390*	6651	7012*	4422			5482*	3605	7034
-4.5m			9004*	9004*	6835*	6835*					4926*	4926*	5691



Lift capacity front and rear.















Lift capacity full circle.

**Notes:**

1. Lifting capacities are based on ISO 10567, that is: 75% of minimum tipping load or 87% of hydraulic lift capacity, whichever is the less. Lifting capacities marked\* are based on hydraulic capacity.
2. Lift capacities assume that the machine is on firm, level ground.
3. Lift capacities may be limited by local regulations. Please refer to your dealer.













**LIFT CAPACITIES - DIPPER LENGTH 2.4M, MONOBOOM, TRACKSHOES: 700HD, NO BUCKET**

**245XR LCD MONO**

Reach	1.5m		3m		4.5m		6m		7.5m		Capacity at Max. Reach		
													
Load Point Height	kg	kg	kg	kg	kg	kg	kg	kg	kg	kg	kg	kg	mm
7.5m					6828*	6828*					5081*	5081*	5585
6m					7081*	7081*	6390*	5673			4640*	4578	6811
4.5m			11686*	11686*	8237*	8237*	6791*	5498	4890*	3857	4530*	3817	7546
3m					9833*	7904	7448*	5230	5802	3765	4628*	3452	7929
1.5m					10950*	7390	7907	4978	5677	3651	4927*	3321	8013
0m					11041*	7164	7725	4817	5593	3574	5289	3392	7808
-1.5m			10237*	10237*	10269*	7138	7673	4771			5825	3715	7289
-3m			10987*	10987*	8598*	7257	6322*	4864			5634*	4513	6376
-4.5m					5121*	5121*					4477*	4477*	4850

**LIFT CAPACITIES - DIPPER LENGTH 3.0M, MONOBOOM, TRACKSHOES: 700HD, NO BUCKET**

**245XR LCD MONO**

Reach	1.5m		3m		4.5m		6m		7.5m		Capacity at Max. Reach		
													
Load Point Height	kg	kg	kg	kg	kg	kg	kg	kg	kg	kg	kg	kg	mm
7.5m							4288*	4288*			3298*	3298*	6327
6m					5780*	5780*	5633*	5633*			3062*	3062*	7429
4.5m			8436*	8436*	7452*	7452*	6308*	5594	5109*	3922	3007*	3007*	8107
3m			10220*	10220*	9126*	8117	7050*	5308	5842	3797	3075*	3075*	8464
1.5m					10544*	7518	7747*	5022	5688	3657	3268*	3016	8543
0m					11059*	7182	7732	4816	5570	3548	3624*	3062	8351
-1.5m	6190*	6190*	9928*	9928*	10659*	7078	7627	4724	5525	3508	4266*	3302	7868
-3m	10456*	10456*	12710*	12710*	9390*	7136	7012*	4753			5482*	3876	7034
-4.5m			9004*	9004*	6835*	6835*					4926*	4926*	5691



Lift capacity front and rear.















Lift capacity full circle.

**Notes:**

1. Lifting capacities are based on ISO 10567, that is: 75% of minimum tipping load or 87% of hydraulic lift capacity, whichever is the less. Lifting capacities marked\* are based on hydraulic capacity.
2. Lift capacities assume that the machine is on firm, level ground.
3. Lift capacities may be limited by local regulations. Please refer to your dealer.













**LIFT CAPACITIES - DIPPER LENGTH 2.4M, TAB, TRACKSHOES: 600HD, NO BUCKET** **245XR LC TAB**

Reach	1.5m		3m		4.5m		6m		7.5m		Capacity at Max. Reach		
													
Load Point Height	kg	kg	kg	kg	kg	kg	kg	kg	kg	kg	kg	kg	mm
7.5m			7057*	7057*	4952*	4952*					5046*	5046*	5657
6m			6756*	6756*	4484*	4484*	4504*	4504*			4575*	4056	6869
4.5m	18167*	18167*	8248*	8248*	5134*	5134*	4527*	4527*	4448*	3414	4408*	3328	7598
3m	8297*	8297*	7990*	7990*	4614*	4614*	4708*	4687	4599*	3307	4324*	2973	7979
1.5m			6873*	6873*	5799*	5799*	5327*	4389	4869*	3172	4439*	2839	8063
0m			6422*	6422*	8346*	6284	6938*	4198	5137*	3082	4779*	2893	7859
-1.5m	10524*	10524*	9413*	9413*	8524*	6255	6576*	4144			4628*	3179	7343
-3m	17864*	17864*	8623*	8623*	5989*	5989*	4390*	4251			3629*	3629*	6427

**LIFT CAPACITIES - DIPPER LENGTH 3.0M, TAB, TRACKSHOES: 600HD, NO BUCKET** **245XR LC TAB**

Reach	1.5m		3m		4.5m		6m		7.5m		Capacity at Max. Reach		
													
Load Point Height	kg	kg	kg	kg	kg	kg	kg	kg	kg	kg	kg	kg	mm
7.5m			5329*		3309*	5329*	3269*	3309*	3269*	3308*	3308*	3308*	6405
6m			5020*		5305*	5020*	3037*	5305*	3037*	3055*	3055*	3055*	7495
4.5m	7489*		7540*	7489*	5178*	7540*	3054*	5178*	3024*	3054*	2984*	2984*	8167
3m	5293*		8028*	5293*	5293*	8028*	3381*	5293*	3194*	3381*	3035*	2701	8522
1.5m			4735*		5035*	4735*	4058*	5035*	3617*	4058*	3206*	2579	8600
0m			5405*		7063*	5405*	5356*	6278	4196*	4202	3532*	2608	8410
-1.5m	7704*	10680*	9480*	7704*	9256*	9480*	7020*	6155	4659*	4090	4115*	2817	7931
-3m	12788*	13263*	8472*	12788*	7141*	8472*	5413*	6232		4127	3791*	3330	7104
-4.5m	17799*	17799*	8726*	8726*	5474*	5474*					4897*	4897*	4997





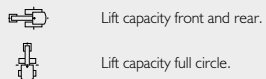





**LIFT CAPACITIES - DIPPER LENGTH 2.4M, TAB, TRACKSHOES: 600HD, NO BUCKET** **245XR LCD TAB**

Reach	1.5m		3m		4.5m		6m		7.5m		Capacity at Max. Reach		
													
Load Point Height	kg	kg	kg	kg	kg	kg	kg	kg	kg	kg	kg	kg	mm
7.5m			7057*	7057*	4952*	4952*					5046*	5046*	5657
6m			6756*	6756*	4484*	4484*	4504*	4504*			4575*	4333	6869
4.5m	18167*	18167*	8248*	8248*	5134*	5134*	4527*	4527*	4448*	3663	4408*	3573	7598
3m	8297*	8297*	7990*	7990*	4614*	4614*	4708*	4708*	4599*	3556	4324*	3204	7979
1.5m			6873*	6873*	5799*	5799*	5327*	4717	4869*	3422	4439*	3067	8063
0m			6422*	6422*	8346*	6765	6938*	4526	5137*	3331	4779*	3128	7859
-1.5m	10524*	10524*	9413*	9413*	8524*	6736	6576*	4472			4628*	3434	7343
-3m	17864*	17864*	8623*	8623*	5989*	5989*	4390*	4390*			3629*	3629*	6427















- Notes:**
- Lifting capacities are based on ISO 10567, that is: 75% of minimum tipping load or 87% of hydraulic lift capacity, whichever is the less. Lifting capacities marked\* are based on hydraulic capacity.
  - Lift capacities assume that the machine is on firm, level ground.
  - Lift capacities may be limited by local regulations. Please refer to your dealer.













**LIFT CAPACITIES - DIPPER LENGTH 3.0M, TAB, TRACKSHOES: 600HD, NO BUCKET** **245XR LCD TAB**

Reach	1.5m		3m		4.5m		6m		7.5m		Capacity at Max. Reach		
													mm
Load Point Height	kg	kg	kg	kg	kg	kg	kg	kg	kg	kg	kg	kg	mm
7.5m			5329*	5329*	3309*	3309*	3269*	3309*		3269*		3308*	6405
6m			5020*	5020*	5305*	5305*	3037*	3037*		3037*		3055*	7495
4.5m	7489*		7540*	7489*	5178*	7540*	3054*	5178*	3024*	3054*	2984*	2984*	8167
3m	5293*		8028*	5293*	5293*	8028*	3381*	5293*	3194*	3381*	3035*	2914	8522
1.5m			4735*		5035*	4735*	4058*	5035*	3617*	4058*	3206*	2791	8600
0m			5405*		7063*	5405*	5356*	6759	4196*	4529	3532*	2825	8410
-1.5m	7704*	10680*	9480*	7704*	9256*	9480*	7020*	6636	4659*	4418	4115*	3050	7931
-3m	12788*	13263*	8472*	12788*	7141*	8472*	5413*	6712		4455	3791*	3596	7104
-4.5m	17799*	17799*	8726*	8726*	5474*	5474*					4897*	4897*	4997

**LIFT CAPACITIES - DIPPER LENGTH 2.4M, TAB, TRACKSHOES: 700HD, NO BUCKET** **245XR LC TAB**

Reach	1.5m		3m		4.5m		6m		7.5m		Capacity at Max. Reach		
													mm
Load Point Height	kg	kg	kg	kg	kg	kg	kg	kg	kg	kg	kg	kg	mm
7.5m			7057*	7057*	4952*	4952*					5046*	5046*	5657
6m			6756*	6756*	4484*	4484*	4504*	4504*			4575*	4111	6869
4.5m	18167*	18167*	8248*	8248*	5134*	5134*	4527*	4527*	4448*	3464	4408*	3376	7598
3m	8297*	8297*	7990*	7990*	4614*	4614*	4708*	4708*	4599*	3356	4324*	3019	7979
1.5m			6873*	6873*	5799*	5799*	5327*	4454	4869*	3222	4439*	2884	8063
0m			6422*	6422*	8346*	6380	6938*	4264	5137*	3132	4779*	2939	7859
-1.5m	10524*	10524*	9413*	9413*	8524*	6351	6576*	4209			4628*	3230	7343
-3m	17864*	17864*	8623*	8623*	5989*	5989*	4390*	4316			3629*	3629*	6427





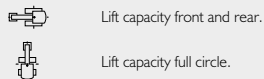







**LIFT CAPACITIES - DIPPER LENGTH 3.0M, TAB, TRACKSHOES: 700HD, NO BUCKET** **245XR LC TAB**

Reach	1.5m		3m		4.5m		6m		7.5m		Capacity at Max. Reach		
													mm
Load Point Height	kg	kg	kg	kg	kg	kg	kg	kg	kg	kg	kg	kg	mm
7.5m			5329*	5329*	3309*	3309*	3269*	3269*			3308*	3308*	6405
6m			5020*	5020*	5305*	5305*	3037*	3037*			3055*	3055*	7495
4.5m	7489*		7540*	7540*	5178*	5178*	3054*	3054*	3024*	3024*	2984*	2984*	8167
3m	5293*		8028*	8028*	5293*	5293*	3381*	3381*	3194*	3194*	3035*	2744	8522
1.5m			4735*	4735*	5035*	5035*	4058*	4058*	3617*	3252	3206*	2621	8600
0m			5405*	5405*	7063*	6374	5356*	4267	4196*	3121	3532*	2651	8410
-1.5m	7704*	9654*	9480*	9480*	9256*	6251	7020*	4155	4659*	3073	4115*	2864	7931
-3m	12788*	13094*	8472*	8472*	7141*	6327	5413*	4192			3791*	3382	7104
-4.5m	17799*	14044*	8726*	8726*	5474*	5474*					4897*	4897*	4997











- Notes:**
1. Lifting capacities are based on ISO 10567, that is: 75% of minimum tipping load or 87% of hydraulic lift capacity, whichever is the less. Lifting capacities marked\* are based on hydraulic capacity.
  2. Lift capacities assume that the machine is on firm, level ground.
  3. Lift capacities may be limited by local regulations. Please refer to your dealer.

**LIFT CAPACITIES - DIPPER LENGTH 2.4M, TAB, TRACKSHOES: 700HD, NO BUCKET** **245XR LCD TAB**

Reach	1.5m		3m		4.5m		6m		7.5m		Capacity at Max. Reach		
													
Load Point Height	kg	kg	kg	kg	kg	kg	kg	kg	kg	kg	kg	kg	mm
7.5m			7057*	7057*	4952*	4952*					5046*	5046*	5657
6m			6756*	6756*	4484*	4484*	4504*	4504*			4575*	4390	6869
4.5m	18167*	18167*	8248*	8248*	5134*	5134*	4527*	4527*	4448*	3715	4408*	3623	7598
3m	8297*	8297*	7990*	7990*	4614*	4614*	4708*	4708*	4599*	3608	4324*	3251	7979
1.5m			6873*	6873*	5799*	5799*	5327*	4784	4869*	3472	4439*	3114	8063
0m			6422*	6422*	8346*	6865	6938*	4594	5137*	3382	4779*	3176	7859
-1.5m	10524*	10524*	9413*	9413*	8524*	6836	6576*	4540			4628*	3488	7343
-3m	17864*	17864*	8623*	8623*	5989*	5989*	4390*	4390*			3629*	3629*	6427

**LIFT CAPACITIES - DIPPER LENGTH 3.0M, TAB, TRACKSHOES: 700HD, NO BUCKET** **245XR LCD TAB**

Reach	1.5m		3m		4.5m		6m		7.5m		Capacity at Max. Reach		
													
Load Point Height	kg	kg	kg	kg	kg	kg	kg	kg	kg	kg	kg	kg	mm
7.5m			5329*	5329*	3309*	3309*	3269*	3269*			3308*	3308*	6405
6m			5020*	5020*	5305*	5305*	3037*	3037*			3055*	3055*	7495
4.5m	7489*		7540*	7540*	5178*	5178*	3054*	3054*	3024*	3024*	2984*	2984*	8167
3m	5293*		8028*	8028*	5293*	5293*	3381*	3381*	3194*	3194*	3035*	2959	8522
1.5m			4735*	4735*	5035*	5035*	4058*	4058*	3617*	3503	3206*	2834	8600
0m			5405*	5405*	7063*	6859	5356*	4598	4196*	3371	3532*	2870	8410
-1.5m	7704*	9654*	9480*	9480*	9256*	6736	7020*	4486	4659*	3324	4115*	3098	7931
-3m	12788*	13094*	8472*	8472*	7141*	6812	5413*	4523			3791*	3650	7104
-4.5m	17799*	14044*	8726*	8726*	5474*	5474*					4897*	4897*	4997



Lift capacity front and rear.



Lift capacity full circle.

**Notes:**

1. Lifting capacities are based on ISO 10567, that is: 75% of minimum tipping load or 87% of hydraulic lift capacity, whichever is the less. Lifting capacities marked\* are based on hydraulic capacity.
2. Lift capacities assume that the machine is on firm, level ground.
3. Lift capacities may be limited by local regulations. Please refer to your dealer.



**ONE COMPANY, OVER 300 MACHINES.**

Your nearest JCB dealer

**Tracked Excavator 245XR**  
 Engine Power: 129kW (173 hp) Operating weight: 25,284-28,009kg Bucket capacity: 0.35 – 1.25 m<sup>3</sup>

JCB Sales Limited, Rokester, Staffordshire, United Kingdom ST14 5JP.  
 Tel: +44 (0)1889 590312 Email: salesinfo@jcb.com  
 Download the very latest information on this product range at: [www.jcb.com](http://www.jcb.com)

©2021 JCB Sales. All rights reserved. No part of this publication may be reproduced, stored in a retrieval system, or transmitted in any form or by any other means, electronic, mechanical, photocopying or otherwise, without prior permission from JCB Sales. All references in this publication to operating weights, sizes, capacities and other performance measurements are provided for guidance only and may vary dependant upon the exact specification of machine. They should not therefore be relied upon in relation to suitability for a particular application. Guidance and advice should always be sought from your JCB Dealer. JCB reserves the right to change specifications without notice. Illustrations and specifications shown may include optional equipment and accessories. All images are correct at time of print. The JCB logo is a registered trademark of J.C. Bamford Excavators Ltd.

