



Thwaites Limited
T0607 Version 3

2.0 - 3.0 Tonne (hydrostatic)

Thwaites

MACH 2071, 2076,
2077, 2080, 2081.

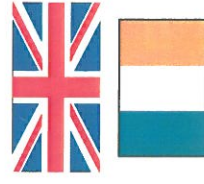

Operator's Instruction Manual

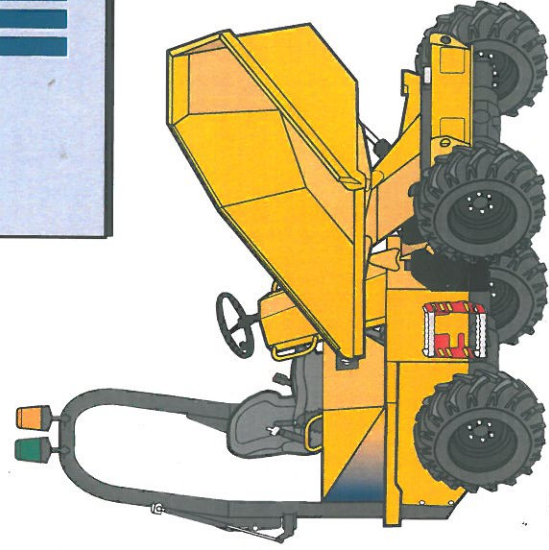

Mach 2077 - 2.3 Tonne Powerswivel

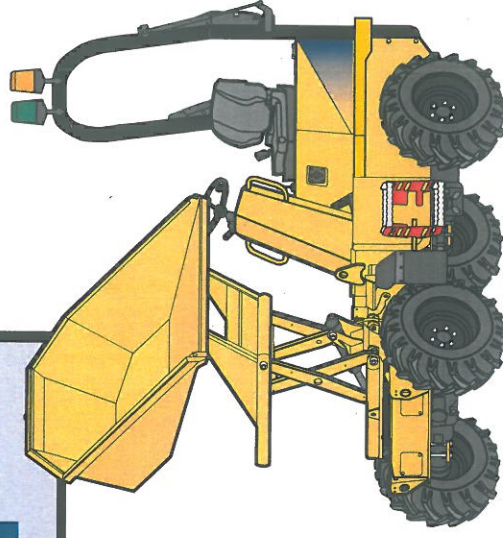

Mach 2071 - 2.0 Tonne Hi Swivel

Introduction

Thwaites Limited puts Safety First

It is the policy of Thwaites Limited to promote safety in the operation of its machines and to create a general awareness of site safety and safe working practices for the operators of its machines.

This Operator's Instruction Manual is intended for both new and experienced machine operators. It should remain with the machine at all times. All operators should be aware of its location and contents.

It is important that all operators are fully trained and familiar with the machine and that they have read and understood the information contained within this book before they attempt to operate in the site conditions for which the machine was designed.

This book details practices and operations which Thwaites Limited recommends. DO NOT operate this machine in ways other than those detailed within this book.

This machine is designed for customary construction site operations, and the transportation of bulk materials commonly carried on such sites; that is their 'intended use'. Under certain controlled conditions the dumper may be used for towing wheeled loads.

Safety Symbols

- Attention!
- Become Alert!
- Your safety is involved



- Correct action



- Incorrect action/procedure which should NOT be carried out

Signal words:

Signal words are used on the machine and within this manual to identify levels of hazard seriousness



DANGER



WARNING



CAUTION

Thwaites

Due to the varied nature of the operation of site dumpers and the absence of an agreed test standard, any figures quoted by Thwaites in relation to vibration values and exposure are for reference purposes only. It is the responsibility of the employer to assess vibration exposure based on the actual site conditions, and operating practices, at the point of use.

Hand Arm Vibration - The daily exposure Action/Limit Values of between 2.5 - 5.0m/s² (A8) are unlikely to be exceeded in an eight-hour reference period.

Whole Body Vibration - The daily exposure can only be accurately determined at the point of use. This exposure must be managed in respect of the Action/Limit Values of 0.5 and 1.15 m/s² (A8) respectively.

Employers should not rely solely on published vibration figures when undertaking risk assessments. Depending on the site conditions, cycle times may need to be adjusted in order to reduce operator exposure levels.

Vibration values based on typical duty cycles are available on request from Thwaites. These may be used for reference purposes only.

1 Before operating this machine

Thwaites

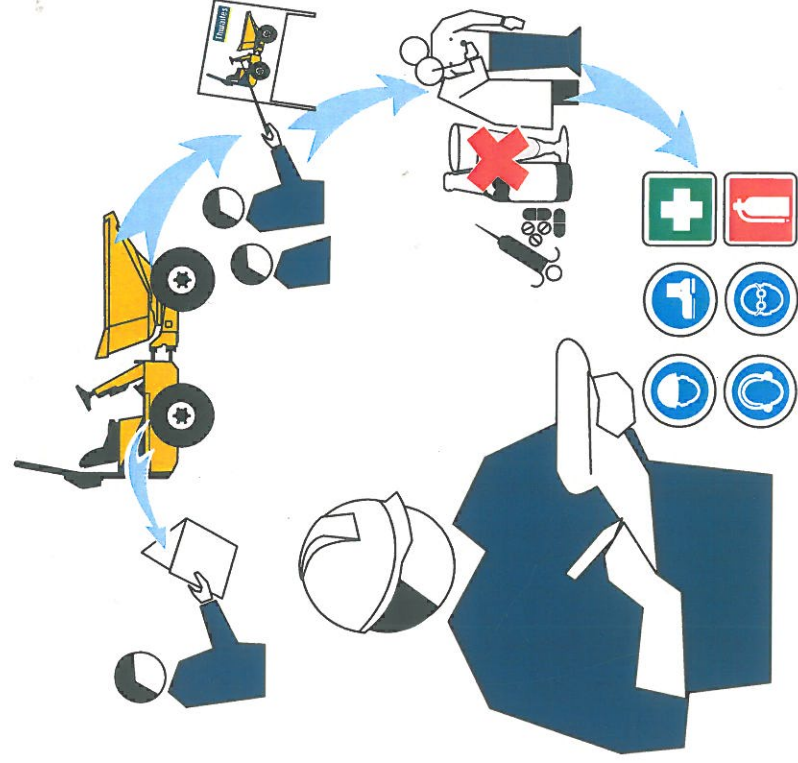

Read this operator's instruction manual

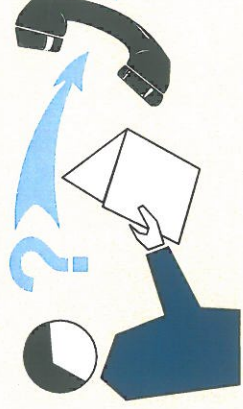

Thwaites
Distributor

- 1 Contact your Thwaites dealer in case of further questions
- 2 Learn to operate this machine
- 3 Ensure that you are fit to operate
- 4 Wear correct safety clothing and ensure that safety equipment is available

Complete checks in section

1

before starting the engine

1 Safety label identification

Thwaites

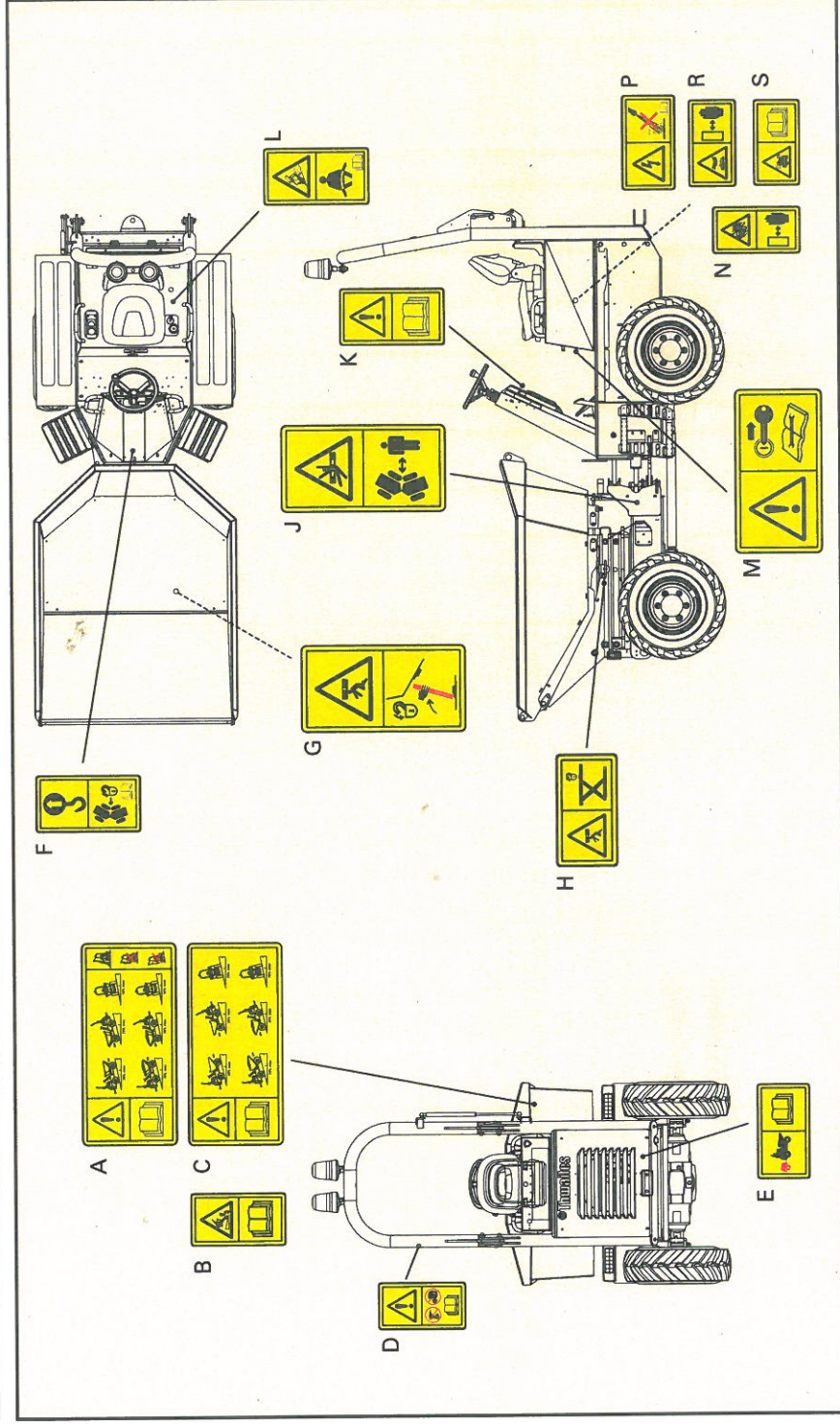

Complete checks in section

1

before starting the engine

1 Safety label identification

Thwaites

Safety labels

The safety labels fitted to these machines are to warn the operator or bystanders of possible hazards.

- Be sure you fully understand the content and position of the labels.
- Ensure labels are clean and in good condition, do not clean labels with solvents.
- Replace lost or damaged safety labels.



There are also other labels in addition to the safety labels, handle these labels in the same way. Orientation of labels may vary from those shown.

Item	Description	Qty	Item	Description	Qty
A	Gradient Front Tip - Read the operator's manual before working on gradients	1	J	Crushing of whole body - Stay a safe distance from articulation area	2
B	Stability hazard - Do not discharge load when working on sloping ground	1	K	Warning - Read the operator's manual before you operate the machine	1
C	Gradient Powerswivel - Read the operator's manual before working on gradients	1	L	Crushing hazard due to machine roll over - Always wear seat belt	1
D	Warning roll over protective structure (ROPS) - Never modify structure	1	M	Warning engine maintenance - Read the service manual before working on the machine	1
E	Warning - Read the operator's manual before towing a trailer	1	N	Warning severing of finger or hand - Keep hands a safe distance from rotating parts (under engine cover)	1
F	Warning lift point - Read the operator's manual before lifting the machine	1	P	Electrical shock - Do not use pressure washer on electrical items (under engine cover)	1
G	Crushing of whole body - Never work under an unpropped skip	1	R	Hot surface - Keep hands a safe distance from hazard (under engine cover)	1
H	Crushing of whole body - Never work under an unlocked scissor frame (Hi swivel model)	1	S	Warning hot fluid under pressure - Read the operator's manual (under engine cover)	1



Complete checks in section

1 before starting the engine

1 Before operating this machine

Thwaites

Walk around the machine

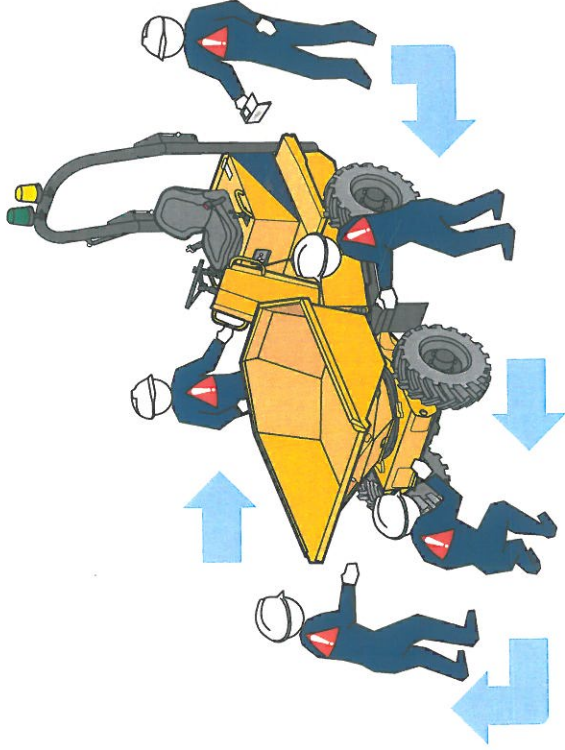

Visually check the machine

- 1 Are the chassis lock and the skip lock disengaged?
- 2 Are the controls, crush zone or hydraulic rams clean, and clear of any debris?
- 3 Is the Roll-Over Protective frame (ROPS frame) secure, fully upright and undamaged?
- 4 Is the seatbelt anchorage secure and serviceable?
- 5 Are the covers and mudguards secure?
- 6 Are the hoses free from fluid leaks?
- 7 Are all safety decals legible?
- 8 Are the tyres free of cuts or splits?
- 9 Are all bolts tight and in position?
10. Are the steering wheel and the steering column undamaged?

11 **Have the daily maintenance tasks been performed? (See section 5)**

Report all faults immediately.



DO NOT OPERATE THE MACHINE UNTIL ALL FAULTS HAVE BEEN RECTIFIED

Complete checks in section

1

before starting the engine

1 Before operating this machine

Thwaites

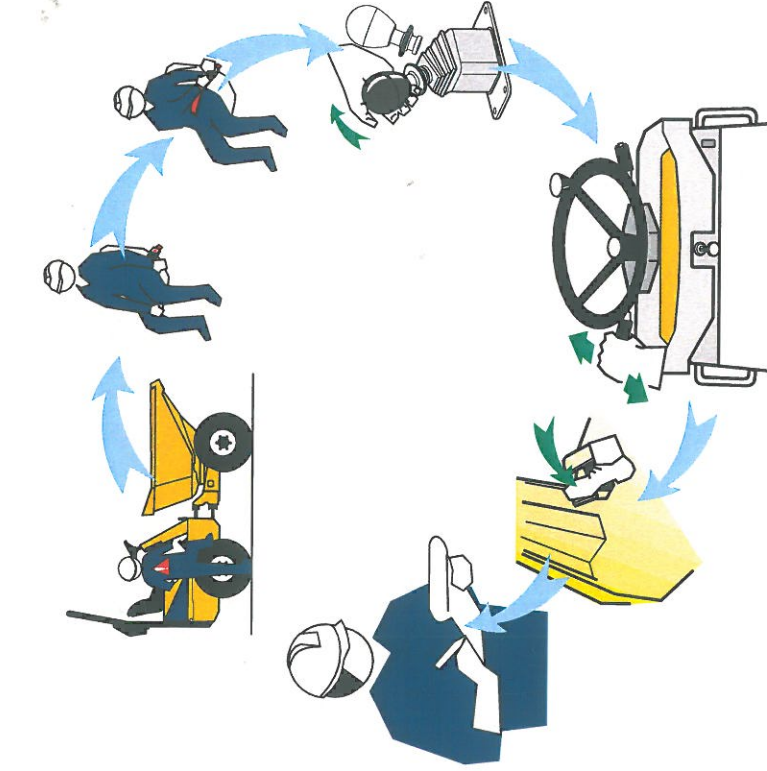

Mount the machine and check the controls

- 1 Use the grabrails and foot steps provided to manoeuvre into seating position. Face the machine at all times when mounting and dismounting
- 2 Is the engine cover secure and locked?
- 3 Adjust the seat position for comfort and easy access to controls
- 4 Fasten the seatbelt. Adjust accordingly for safety and comfort
- 5 Is the hand brake ON?
- 6 Set the transmission to neutral
- 7 Does the foot brake feel firm?
- 8 Do not operate the machine without understanding all its controls as described in the following pages



 **WARNING**

Seatbelt **MUST BE WORN** when operating machines fitted with ROPS frame.

Complete checks in section

1

before starting the engine

1 Layout of controls

Thwaites

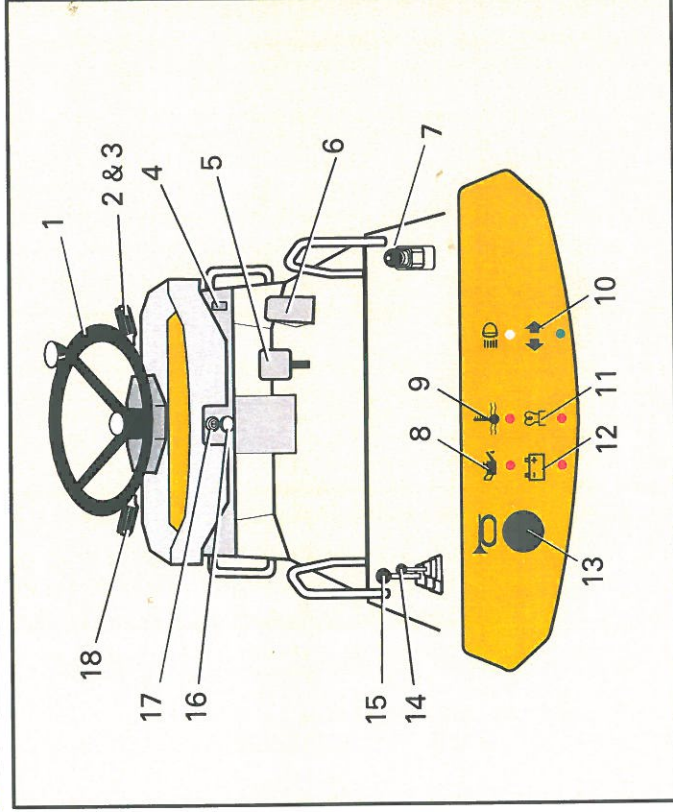

Control location & functions

1. Steering wheel
2. Direction indicator selector - forward = left turn - back = right turn*
3. Lights - twist 1 = sidelights ON twist 2 = headlights ON*
4. Hazard warning light switch*
5. Foot brake pedal
6. Throttle pedal
7. Hand brake lever
8. Engine oil pressure warning light
9. Water temperature warning light
10. Direction indicator pilot light*
11. Heat/start pilot light
12. Battery charging warning light
13. Horn push
14. Raise-skip lever (hi swivel model only)
15. Tip-skip lever (Fwd tip model)
16. Tip-skip and rotate-skip lever (powerswivel and hi swivel models)
17. Ignition & hand brake warning buzzer
18. Ignition switch
18. Forward/Neutral/Reverse (FNR) lever

* Optional items

Complete checks in section

1

before starting the engine

1 Layout of battery

Thwaites

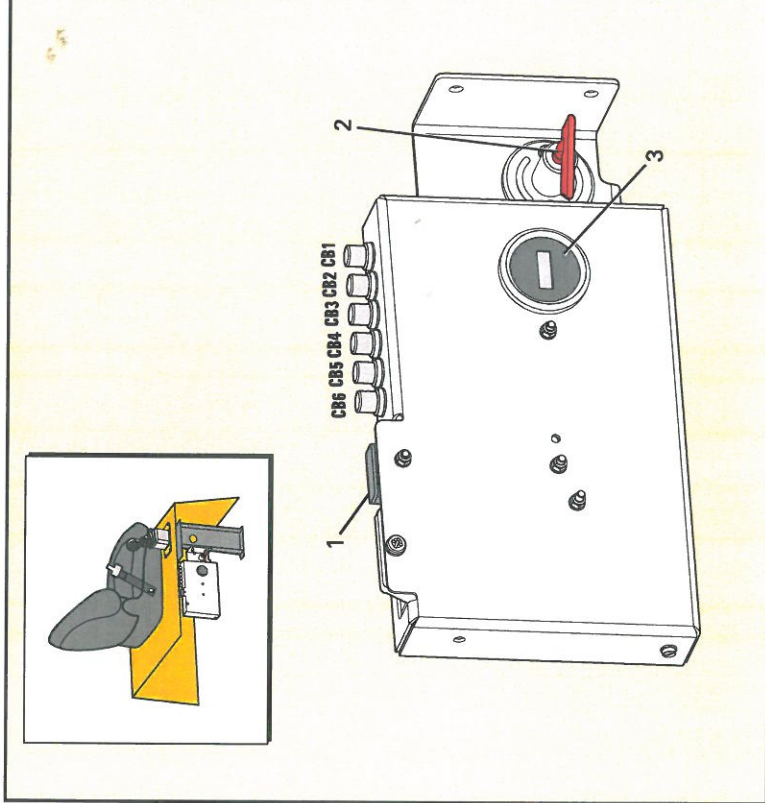
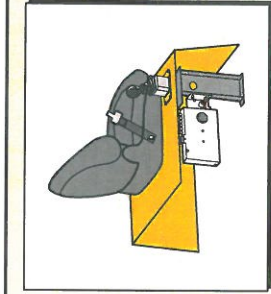

- 1 Maxi fuse
 - 2 Isolater switch
 - 3 Hour meter
 - CB1 Transmission
 - CB2 Power
 - CB3 Lights* / Beacon / Horn
 - CB4 Hazard* / Lights*
 - CB5 LH side lights*
 - CB6 RH side lights*
- * Optional items

Complete checks in section **1**

1 before starting the engine

1 Control functions – explained

Thwaites

Seat adjustment

- A – Turn knob to set driver weight
- B – Lift to slide seat assembly forwards/backwards
- C – Lift handle to adjust backrest

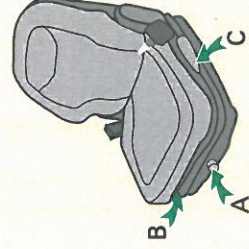

Adjusting the seat belt

- Adjust length of belt when seated on the machine
- Press buckle blade into buckle lock
- Pull belt webbing through buckle blade to remove slack

 Seatbelt should not be worn loose. It should pass comfortably across hip bones and not the abdomen.

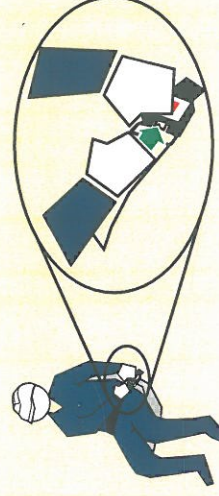

Complete checks in section

1

before starting the engine

1 Control functions – explained

Tip-skip lever (forward tip model)

- Push forward to tip skip
- Push backwards to return skip

Rotate-skip lever (swivel models)

- Raise skip 100 mm (4") to disengage pivot centring lock
- Rotate skip, fully lowered, to automatically engage centring lock
- Raise skip and push lever to the right to rotate skip to right
- Raise bucket and push lever to the left to rotate skip to left
- Push forward to tip skip
- Push backwards to return skip
- Increased engine speed reduces cycle times

 Movement of the skip is disabled if the steering wheel is moved (Priority Steering)

Raise-skip lever (Hi swivel model only)

- Push forward to raise skip
- Push backwards to lower skip

Thwaites

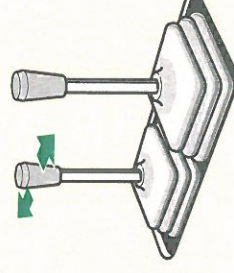
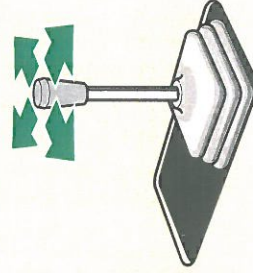
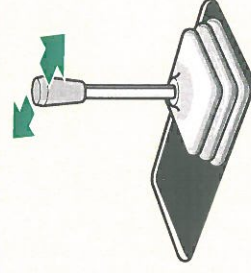

Complete checks in section

1

before starting the engine

1 Control function – explained

Thwaites

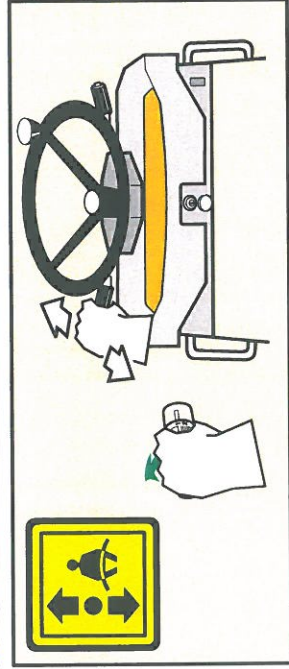

FNR lever

- Push forwards to travel in a forward direction
- Lever centred = neutral
- Pull back to travel in a reverse direction
- Twist lever anti-clockwise for HIGH-speed travel
- Twist lever clockwise for LOW-speed travel

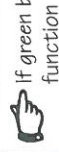

if green beacon option is fitted seat belt must be buckled for lever to function

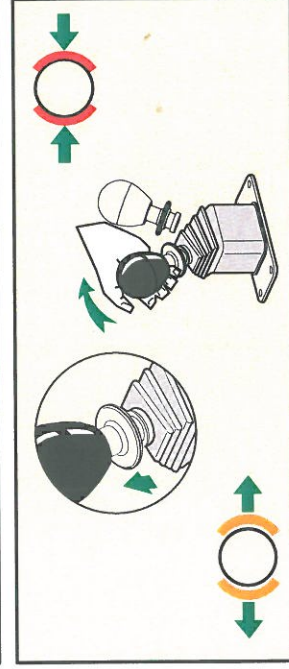

Hand brake lever - right hand

- Use only when the machine is stationary (or in an emergency)
- Pull lever back to apply, lift collar pull back and release collar to lock.
- Lift collar and lever will move forward to release.



An audible warning device is fitted to your machine. This will sound if the parking brake is engaged whilst forward or reverse is selected and machine will not move.

Engine will not start if parking brake is not engaged.

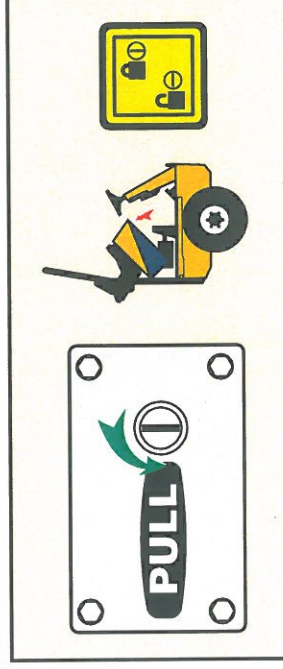

Engine cover open/close

- Insert ignition key and turn anti-clockwise to unlock
- Pull handle to release and raise cover
- Lower cover, secure and lock before driving

Complete checks in section



before starting the engine

1 Control functions – explained

Steering wheel

- Turn the wheel clockwise to turn machine to right
- Turn the wheel anticlockwise to turn machine to left

 Ensure the non-steering hand is on the engine cover grabrail when using the spinner knob for low-speed single-handed steering

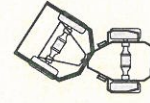
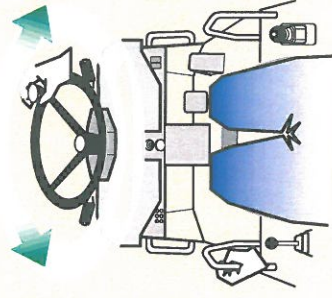

Thwaites

Throttle pedal – right foot

- Apply pressure to increase speed
- Reduce pressure from the pedal to reduce speed

Foot brake pedal + inching pedal – right foot

- Apply pressure to slow or stop the machine

 Use left foot when inching is required:

Push down while pressing throttle pedal with right foot and release to move machine

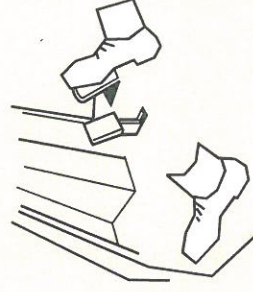

1 Control functions – explained

Thwaites

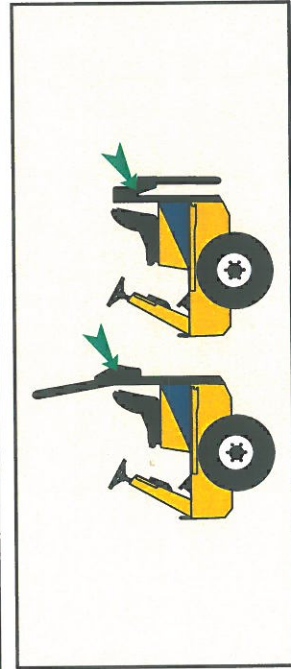

Raising and Lowering the folding ROPS frame

- Remove linch pins and withdraw frame lock pins
- Lower frame and insert lock pins and linch pins in new position
- Reverse the procedure to raise the frame
- Ensure all pins are secure before driving

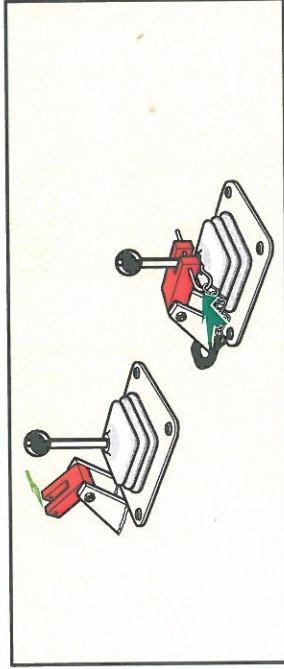

Tip-skip lever lock (optional)

- Place yolk over tip-skip lever and secure with linch pin

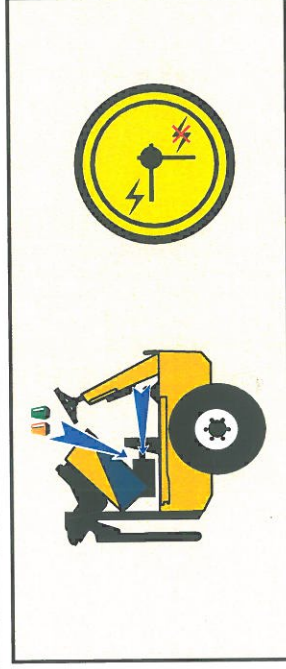

Beacon storage

- Unscrew and remove beacons
- Secure beacons on brackets provided beneath bonnet

Battery isolator (beneath engine cover)

- Turn key anti-clockwise to isolate the battery power supply

Complete checks in section



before starting the engine

2 How to START and STOP the engine

Thwaites

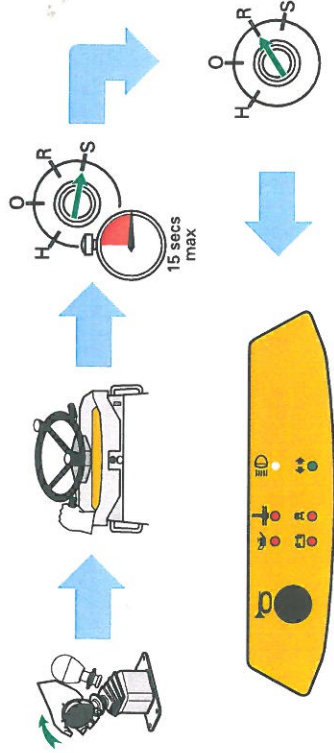

To start the engine

- Apply hand brake
- Set FNR lever to neutral
- Cold start aid (when required)-

Turn key to position 'H'. When panel light extinguishes start engine (as above).

- Turn the key clockwise to the start position 'S'
- All panel lights self-test (illuminate) and should extinguish on start-up.
- Allow the engine to turn for 15 seconds max.
- If the engine does not start within 15 seconds, return key to position 'O' and wait 30 seconds before turning to 'S' again.
- When the engine fires, release key.
- (The key will spring back to 'Run' position 'R').

To Stop The Engine

- Turn key to position 'O'.



WARNING

DO NOT START THE ENGINE UNLESS SEATED IN THE DRIVING POSITION



CAUTION

If a panel light remains ON switch off engine (key to 'O') and investigate problem.



CAUTION

- Do not use unauthorised starting aids.
- Do not TOW or BUMP start.



2

Complete checks in section

before loading the machine

2 Preliminary checks

Thwaites

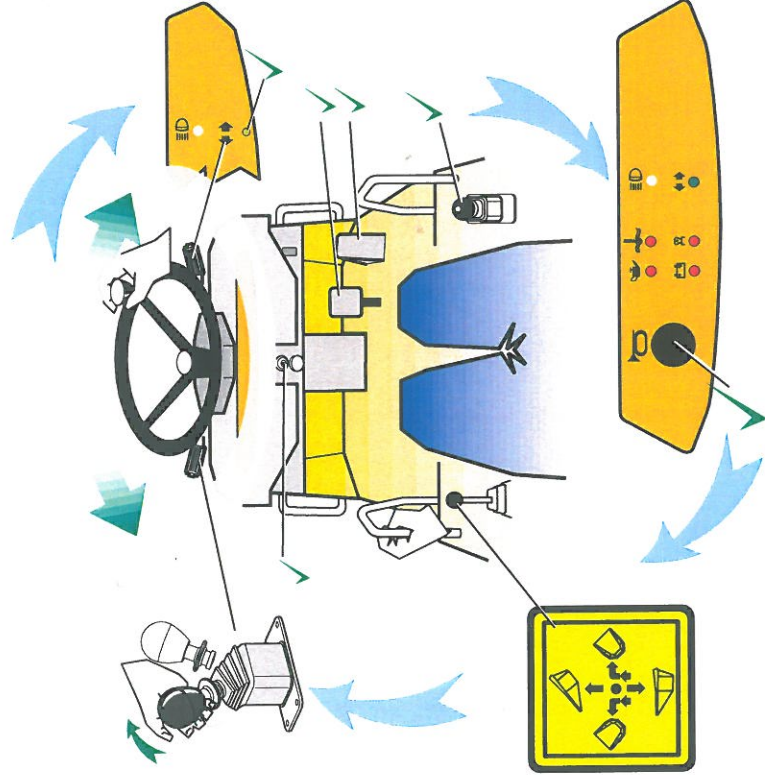

Function checks - engine ON

Brakes

- Does the foot brake pedal feel firm?
- If the hand brake is on, and a gear is selected, a buzzer will sound and the drive may be disconnected.

Steering

- Rotate steering wheel clockwise and anti-clockwise

Electrics

- Does the horn sound correctly?
- Does the reverse alarm sound correctly?
- Are the beacons flashing?
- Are the lamps working correctly? (optional) –

- * Side lights
- * Head lights
- * Stop
- * Indicators
- * Hazards

Tip-skip lever/Rotate-skip lever

- Discharge/park skip
- Rotate - right to left/Left to Right. (powerswivel and hi swivel models).

Raise-skip lever

- Raise/Lower bucket. (Hi swivel model only)

Complete checks in section

2

before loading the machine

3







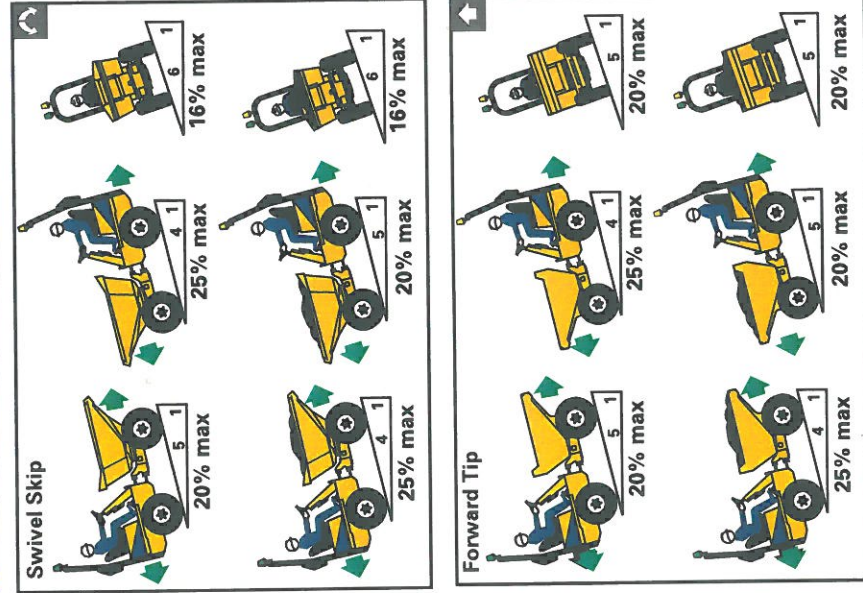



DANGER

IMMEDIATE HAZARDS WHICH WILL RESULT IN SEVERE PERSONAL INJURY OR DEATH

Thwaites



WORKING ON GRADIENTS

-  DO NOT exceed maximum stated gradients
-  DO NOT turn across gradients
-  DO NOT brake suddenly in wet, muddy, icy conditions or when operating on loose surfaces
-  DO NOT run downhill with controls in neutral
-  DO NOT operate skip-raise lever (Hi swivel model) on sloping ground. 
-  Travel straight up, down or along a gradient
-  Keep speed to a minimum and use the foot brake to reduce speed when travelling down gradients
-  To prevent movement, always engage hand brake when stopped on sloping ground. Chock wheels securely when leaving the machine unattended
-  Always position swivel-skip in central lock

3

DANGER

IMMEDIATE HAZARDS WHICH WILL RESULT IN SEVERE PERSONAL INJURY OR DEATH

Thwaites

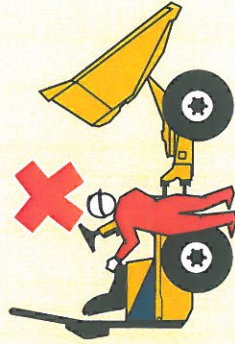

CRUSH ZONE

Stay clear of articulation area when the engine is running
Never operate machine controls when standing on either side of machine

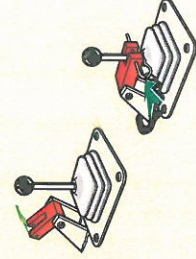

WORKING UNDER A RAISED SKIP

Lock skip safety prop during maintenance

Never work under an unpropped skip

When using skip safety prop engage tip-skip lever lock (if fitted)



3

DANGER

IMMEDIATE HAZARDS WHICH WILL RESULT IN SEVERE PERSONAL INJURY OR DEATH

VISIBILITY

The visibility maps show machines in standard build and travel configuration.

The maps provide an approximate indication of what can be seen by the operator and any blind spots when seated in the driving position wearing a seatbelt.

The maps have been provided to assist the operator / user and may be used as part of a risk assessment for the safe operation of the machine.

The machines are compliant with the visibility requirement given in EN 474-1 with regards to the rectangular boundary and a test object of 1.2m high and 0.3m wide and the 12m circular boundary.

- Check all around the machine before operation.
- Be sure all mirrors are adjusted before operating the machine (if fitted).
- All cameras and mirrors must be kept clean (if fitted).
- Be aware of all blind spots.

 The blind spot areas marked on the plan views of these maps are ground plane only

WARNING

Camera angles are factory set, any modifications to the machine configuration by any end user that may result in the restriction of visibility and will require a new risk assessment to be performed.

Thwaites

Mach 2071

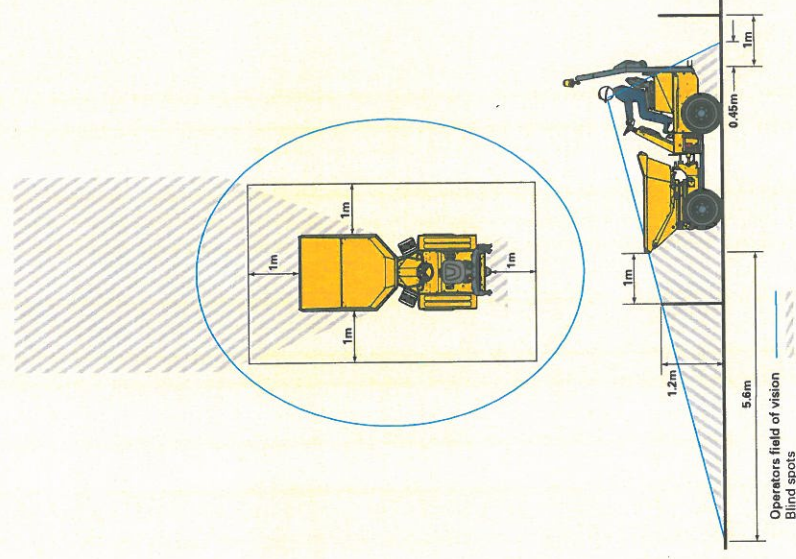

3 

DANGER

IMMEDIATE HAZARDS WHICH WILL RESULT IN SEVERE PERSONAL INJURY OR DEATH

Thwaites

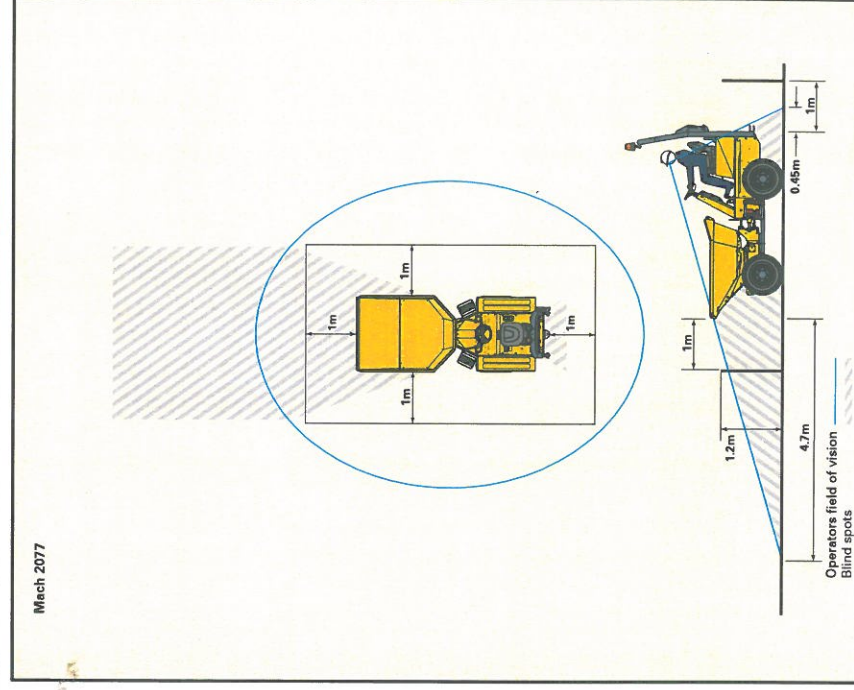
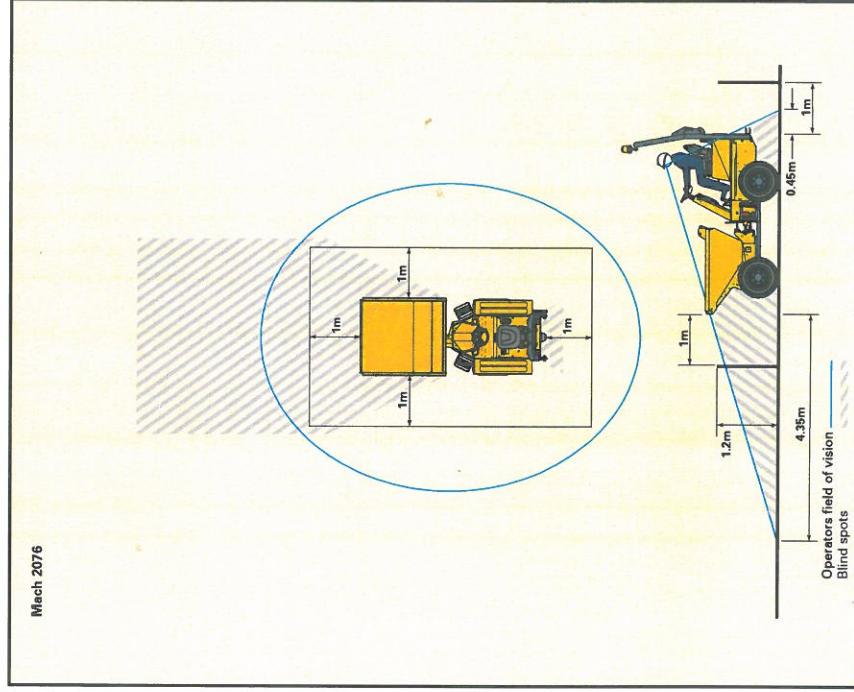

3 

DANGER

IMMEDIATE HAZARDS WHICH WILL RESULT IN SEVERE PERSONAL INJURY OR DEATH

Thwaites

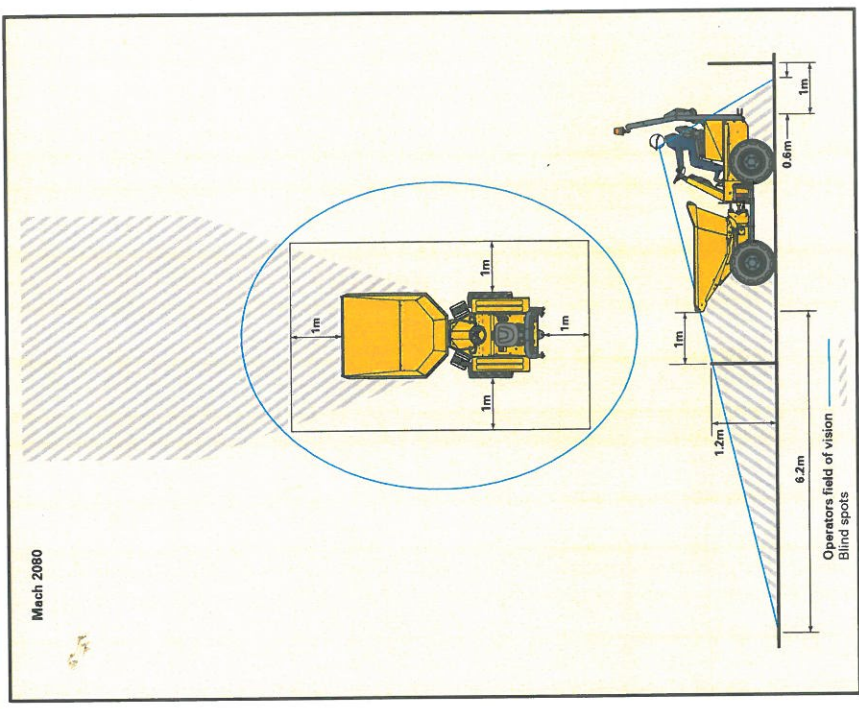
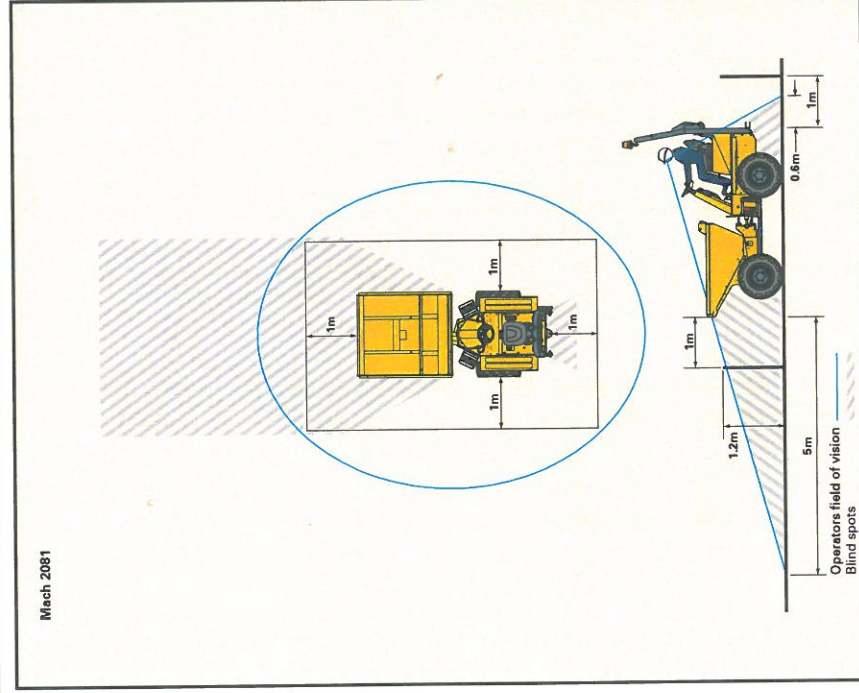

Attention! Section

3 correct and incorrect working practices

3

WARNING

HAZARDS OR UNSAFE PRACTICES WHICH COULD RESULT IN SEVERE PERSONAL INJURY OR DEATH

Thwaites

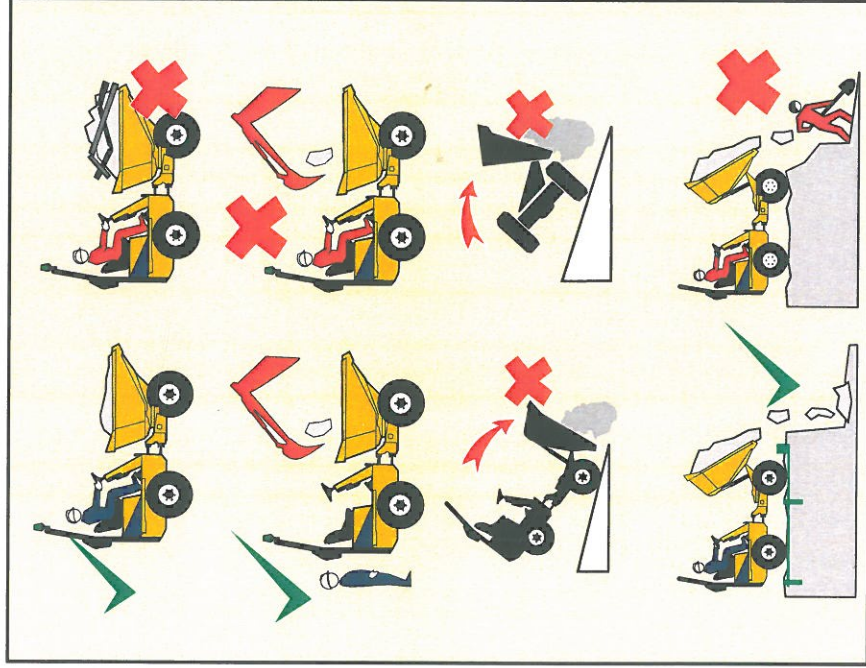

LOADING THE MACHINE
DO NOT exceed the machine's rated capacity

Activate the hand brake, set drive to neutral, turn the engine off, disembark the machine, and stand clear



Clear any debris from controls



Ensure **SAFE STABLE LOW** load which allows good visibility



Reduce payload if materials being carried are not free flowing



UNLOADING THE MACHINE
Use **STOPBOARDS** and **SUPPORT** walls on trenches



DO NOT tip skip if load is sticking



DO NOT discharge load when working on sloping ground











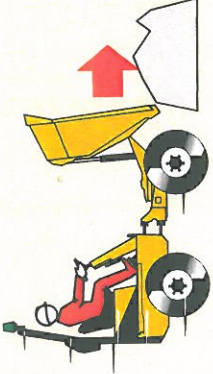

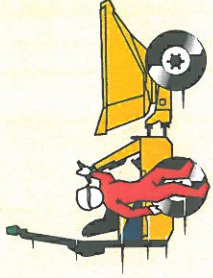

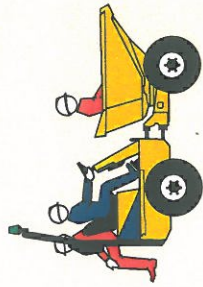
3 

WARNING HAZARDS OR UNSAFE PRACTICES WHICH COULD RESULT IN SEVERE PERSONAL INJURY OR DEATH

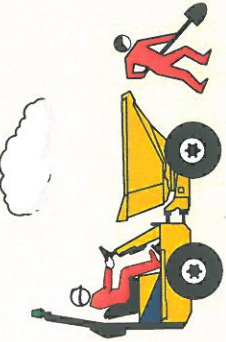
Thwaites

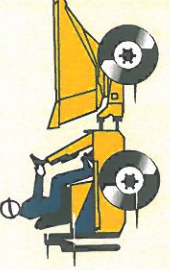
DRIVING

		<p>DO NOT drive with the skip tipped (bulldozing)</p>			<p>NEVER dismount from a moving machine</p>
		<p>DO NOT carry passengers</p>			<p>Avoid confined work areas - exhaust fumes and noise can be a hazard</p>
		<p>Site hazards to avoid: adverse weather conditions; icy surfaces; people</p>			<p>DO NOT operate with the ROPS frame folded down</p>

3

WARNING

HAZARDS OR UNSAFE PRACTICES WHICH COULD RESULT IN SEVERE PERSONAL INJURY OR DEATH

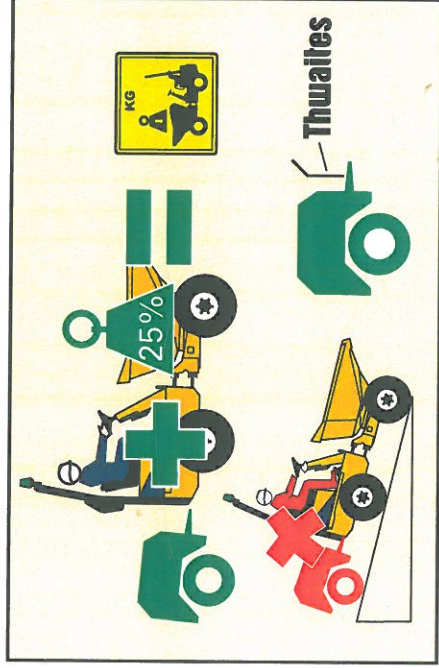

-
-
-
-
-

TOWING A TRAILER

Place ballast load in skip. This load should be a minimum of 25% of the machine's rated payload.

Gross weight to be towed plus the ballast load **MUST NOT** exceed rated payload of machine.

DO NOT exceed maximum tow bar pull or vertical load.

Towing must not be carried out on sloping ground.

Always use Thwaites-approved towing pin.

Thwaites

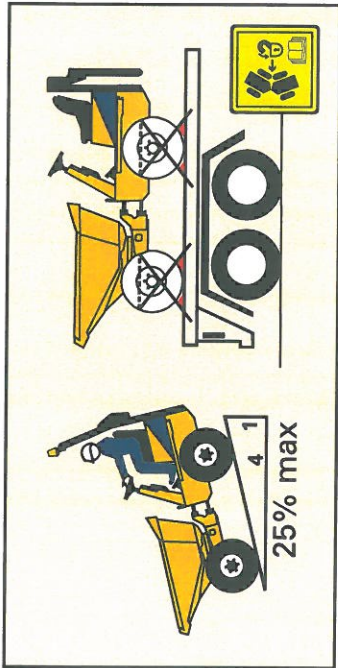

-
-
-
-

TRANSPORTATION

When transporting or storing machine with the ROPS frame folded down remove beacons and secure beneath the bonnet. Reverse machine slowly onto a suitable trailer.

DO NOT drive the machine forwards when loading.

- Apply hand brake
- Stop engine
- Chock wheels *(To prevent movement)*
- Engage chassis locking bar
- Secure to trailer
- Ensure legal load *(Height/weight)*

3

Attention! Section

correct and incorrect working practices

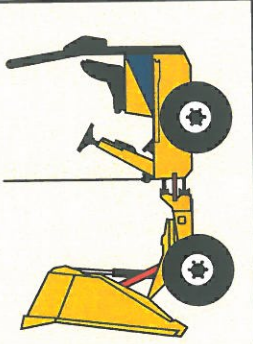

LIFTING

- Tip skip fully forward
- Engage skip safety prop
- Engage chassis locking bar
- Lift using centre eye provided

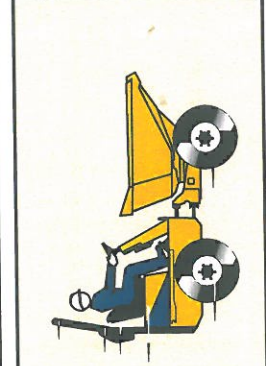

HAND BRAKE

- DO NOT** apply hand brake if machine is moving (except in an emergency)

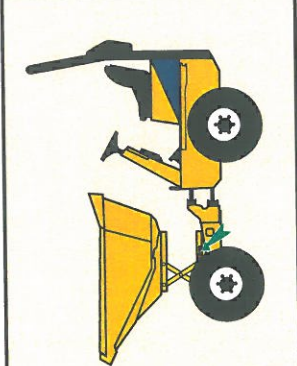

SCISSOR LIFT

- Insert locking pin when working beneath skip



CAUTION

HAZARDS OR UNSAFE PRACTICES WHICH **COULD** RESULT IN MINOR PERSONAL INJURY OR PRODUCT OR PROPERTY DAMAGE

Thwaites

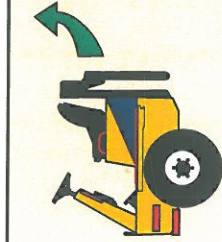

HINGED ROPS

Use grab handles, tread grips (if fitted) and steps when standing on the machine to lower the ROPS frame.



Avoid wet surfaces.



Never modify structure

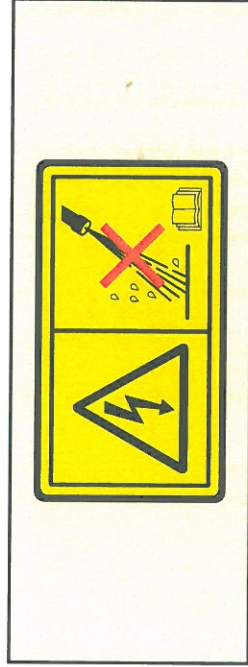

ELECTRICAL SYSTEM DAMAGE

When pressure washing the machine avoid electrical system or component damage. DO NOT aim directly at electrical components housed beneath the engine cover or located within the instrument panel.



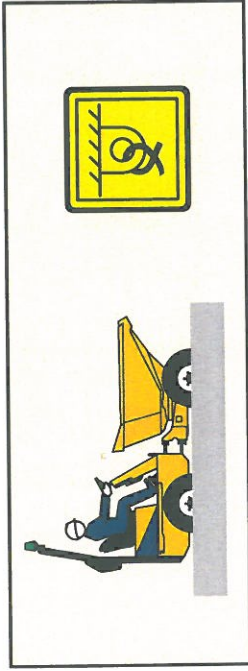

MACHINE RECOVERY

Towing procedure

Ensure towing straps or chains are suitable for the machine to be towed. (1.5 time more than the gross weight.)

Tow the machine using the front tie down points or around the rear axle.

Tow the machine in neutral with the engine running.

Moving a disabled machine

Towing or pushing a disabled machine can only be done after the following has been carried out.

- The hydrostatic pump is opened.
- Handbrake emergency release procedure.



WARNING

If rear axle brakes and pump are not disengaged damage will be caused to transmission and hydraulics.



CAUTION

HAZARDS OR UNSAFE PRACTICES WHICH **COULD** RESULT IN MINOR PERSONAL INJURY OR PRODUCT OR PROPERTY DAMAGE

Thwaites

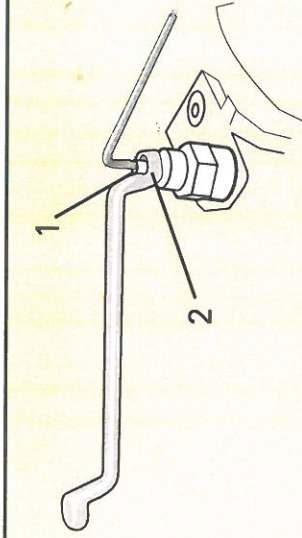

Open hydrostatic pump

In order to tow the dumper, the high-pressure circuit at the hydrostatic pump must be opened.

To open the pump, follow this procedure:

At the left side of the pump below the floor plate there is one high-pressure control valve at the top, and another at the bottom.

To activate the hydrostatic transmission bypass:

- release lock nut (2);
- screw in grub screw (1) until flush with top of nut (2);
- tighten nut (2).
- Reverse procedure prior to machine being placed back into service.



WARNING

- The maximum towing speed of 2 km/h should not be exceeded.
- The towing distance should not exceed 1 km.



CAUTION

HAZARDS OR UNSAFE PRACTICES WHICH **COULD** RESULT IN MINOR PERSONAL INJURY OR PRODUCT OR PROPERTY DAMAGE

Thwaites

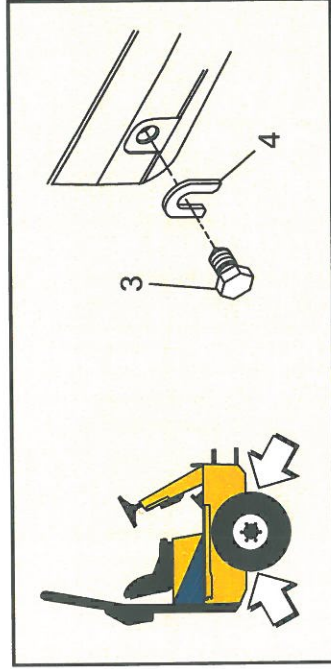

To release the fail safe brake:

- Loosen the two screws (3) on the axle housing and remove the spacers (4).
- Tighten the screws (3) by hand until they are in contact with the internal pusher plate. After tightening the screws, alternatively, for ¼ of turn on each side, with a wrench until they are completely tightened.

RESET OF FAILS SAFE BRAKE FUNCTION

- Loosen again the screws (3) alternatively for ¼ of turn on each side and fit in the spacer (4) between the screw head and the axle cover.
- Tighten the screws (3) completely against the spacer with torque of 95 - 115 N·m.

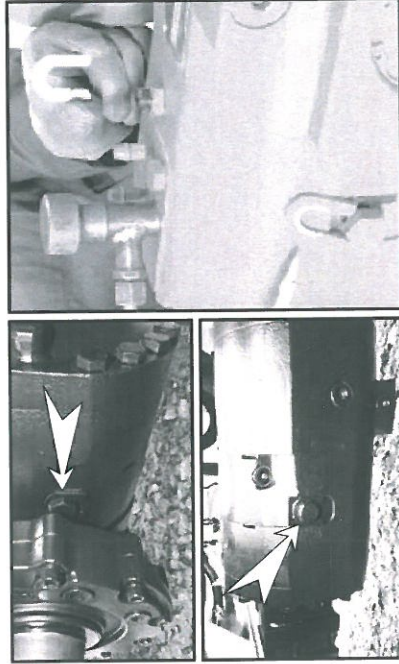

TOWING THE MACHINE

- The maximum towing speed of 2 km/h should not be exceeded.
- The towing distance should not exceed 1 km.







Attention! Section

3 correct and incorrect working practices

4 Troubleshooting

Thwaites

Problem	Reason	Solution
Engine will not start	Isolator switch OFF FNR not in neutral Battery voltage too low Faulty fuel supply Electrical stop on fuel pump defective Circuit breaker tripped Seat belt not fastened (if green beacon fitted)	Switch on Shift FNR lever to neutral Check battery and connections Check fuel level and connections Check connections Rectify electrical fault and reset (push to reset) Fasten seat belt
Complete loss of electrical functions	Maxi fuse blown	Rectify electrical fault and replace fuse
Starter motor will not operate	Faulty battery	Replace
Maxi fuse blown	Faulty starter motor/solenoid (Current drawn by solenoid exceeds 25A) Short circuit on main feed or starter solenoid cables	Replace starter motor/solenoid and maxi fuse (only replace with a 30-amp fuse) locate and repair
Engine starts and stops	Blocked fuel or air filter Air in fuel system	Replace fuel or air filter Check fuel line connections
Black engine smoke	Air filter clogged (Indicator on air filter is red) Fuel system defect Wrong fuel	Replace or clean air filter Contact Thwaites dealer Replace fuel and filter
 Engine oil pressure  High engine temperature  Irregular alternator  Warning buzzer sounds	Low oil level Radiator choked Low coolant level Defective or loose alternator belt Hand brake ON	Top up engine oil Clean radiator Top up coolant Adjust, or, if necessary, replace alternator belt Release hand brake

Always check panel warning lights, tripped circuit breakers or blown maxi fuse

4 Powerswivel and Hi swivel – data chart

Thwaites

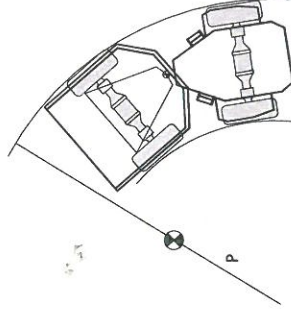
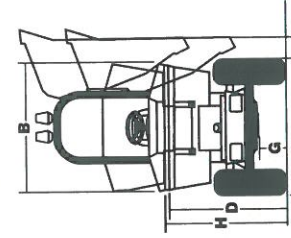
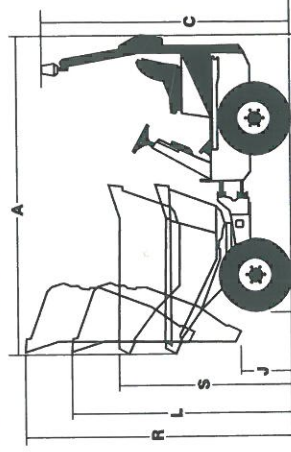

Dimensions (mm)	2T Hi Sw	2.3T	3T	Weight (kg)	2T Hi Sw	2.3T	3T	Noise
A. Length.....	3726	3726	3934	Unladen				Airborne (10m)
B. Width.....	1471	1471	1638	Front axle.....	910	700	760	101dB
C. Height (ROPS & Beacon).....	3053	3053	3180	Rear axle.....	1370	1370	1410	Operator
D. Bucket lip height.....	1479	1356	1456	Total.....	2280	2070	2170	84
E. Width over tyres.....	1488	1488	1650	Laden (including driver at 80 kg)				
F. Wheelbase.....	1850	1850	1950	Rated payload.....	2000	2300	3000	
G. Ground clearance.....	282	282	337	Front axle.....	2690	2750	3450	
H. Bucket load height.....	1536	1416	1581	Rear axle.....	1670	1700	1800	
I. Axle to rear.....	1042	1042	1042	Total.....	4360	4450	5250	
J. Tipping ground clearance.....	1236	728	751	Towbar (Max)				
K. Tipping tyre clearance.....	525	475	546	Pull load.....	1500	1725	2250	
L. Height tipped (skip).....	3152	2671	2841	Vertical load.....	375	375	375	
M. Height (ROPS folded).....	1926	1926	1981	Tyre Pressure				
N. Tipping side clearance.....	239	189	388	Bar (psi)Front.....	3.5(51)	3.5(51)	3.6(52)	
O. Tyre clearance diameter (m).....	7.4	7.4	9.2	Rear.....	2.3(33)	2.3(33)	2.0(29)	
P. Max height tipped (raised skip).....	3642							
Q. Bucket load height (raised skip).....	1971							

Typical vibration levels - whole body 0.7 - 0.8 m/s². Hand/arm less than 2.5 m/s².

4 Forward tip – data chart

Thwaites

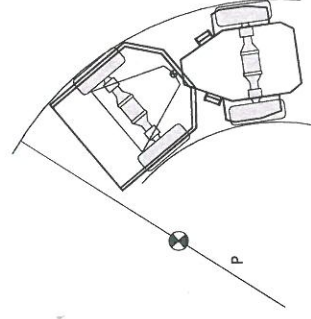
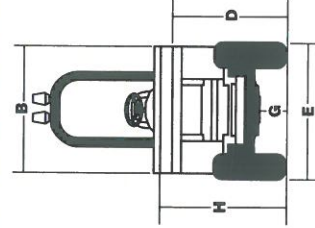
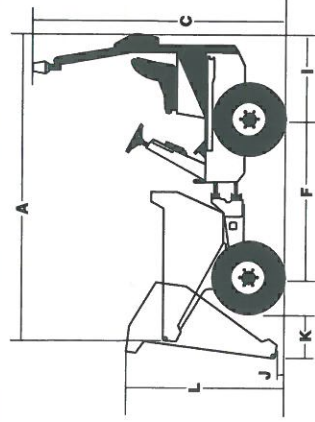

Dimensions (mm)	2T	3T	Weight (Kg)	2T	3T	Noise
A. Length.....	3603	3785	Unladen			Airborne (10m) 101dB Operator 84
B. Width.....	1490	1650	Front axle.....	590	620	
C. Height (ROPS & Beacon).....	3053	3108	Rear axle.....	1330	1420	
D. Bucket lip height.....	1346	1381	Total.....	1920	2040	
E. Width over tyres.....	1488	1650	Rated payload (including driver at 80 kg)			
F. Wheelbase.....	1850	1950	Laden.....	2000	3000	
G. Ground clearance.....	282	337	Front axle.....	2300	3160	
H. Skip load height.....	1431	1524	Rear axle.....	1700	1960	
I. Axle to rear.....	1042	1042	Total.....	4000	5120	
J. Tipping ground clearance.....	278	321	Towbar (Max)			
K. Tipping tyre clearance.....	594	603	Pull load.....	1500	2250	
L. Height tipped (skip).....	2001	2131	Vertical load.....	500	500	
M. Height (ROPS folded).....	1926	1981	Tyre Pressure			
P. Tyre clearance diameter (m).....	7.4	9.2	Bar (psi) Front.....	3.5 (51)	3.6(52)	
			Rear.....	2.3 (33)	2.0(29)	

Typical vibration levels - whole body 0.7 - 0.8 m/s². Hand/arm less than 2.5 m/s².

5 Maintenance Tasks

Safe Working Practice:

Before lubrication and maintenance tasks:

- Machine must be on firm level ground.
- Apply parking brake.
- Stop engine and remove ignition key.
- Isolate the battery (See section 1 - Battery isolator)
- Allow engine to cool.
- Place FNR/gear lever in neutral.
- Fit chassis locking bar
- Chock the wheels
- Prop bucket when working beneath
- Lock skip safety prop(s)

 Refer to service manual for further reference



WARNING - FUEL HANDLING

- Diesel fuel is FLAMMABLE.
- Never refuel or service the fuel system while smoking or near naked flames.
- Never refuel the machine while the engine is running.

Thwaites

Recommended maintenance tasks:

- Turn ignition switch 'ON' without starting engine, and wait 2 seconds for all warning lamps to turn off.
- Note any lamp that remains lit and correct system fault identified before operating the machine.
- Turn ignition switch 'OFF'.

Daily (10 hour) maintenance check list:

- Diesel fuel level
- Engine oil level
- Engine coolant level
- Hydraulic tank oil level
- Hand brake function
- Foot brake resistance
- Steering wheel and column condition
- Tyre pressure
- Air cleaner indicator

Weekly (50 hour) maintenance check list:

- Wheel nut torque
- Brake oil level
- Fan belt
- Sufficient lubricant in all grease points

First (100 hours) - New machine - change:

- Axle oil (Refer to service manual for procedure)

5 Daily (10 Hour) maintenance checks

Thwaites

Diesel fuel tank volumes

- Check fuel level on gauge (Fig 1, A) and fill fuel tank through filler cap (Fig 1, B) with required amount of diesel, noting MAX/MIN volumes and fuel quality:

Maximum	24.5 litres
Gauge indicates empty	3.0 litres

Engine oil level

- Pull out lubricating oil dipstick and wipe clean (Fig 2, A)
- Insert lubricating oil dipstick as far as it will go.
- Pull out lubricating oil dipstick, ensure oil level is between the MIN and MAX markers (Fig 3).
- Top up to MAX marker if necessary, through oil filler cap, using recommended oil. Machine initially filled with SAE15W40 (Fig 2, B).

CAUTION - COMPLIANT FUEL USAGE

To avoid fuel system damage and to satisfy exhaust gas legislation, fuel used in this machine **MUST** comply with one of the following approved low sulphur diesel specifications. DIN 51628, EN 590 or BS 2869 (Sulphur <10 mg/kg)

CAUTION - HOT FLUIDS

Check oil levels with machine on firm, level ground and with the machine cooled down.

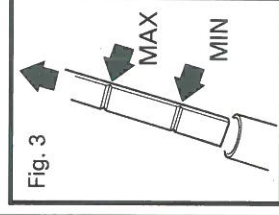
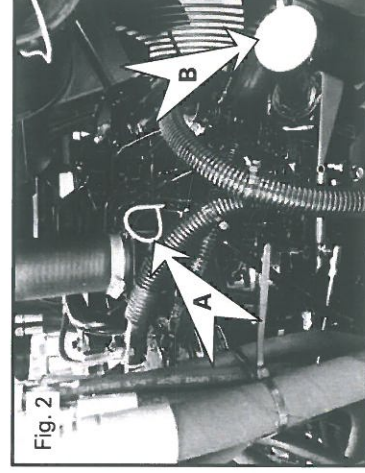
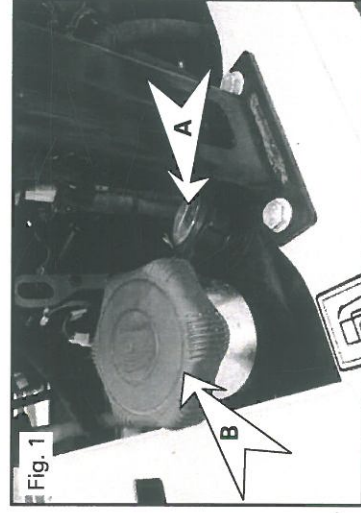

5 Daily (10 Hour) maintenance checks

Thwaites

Engine coolant level

- View level of coolant in expansion bottle
- The coolant level must always be between the MIN and MAX marks (Fig 1).
- Top up at radiator cap if necessary (Fig 2).

 Use the correct concentration of coolant. Machine initially filled with water plus 50% antifreeze to BS.6580.

Hydraulic oil level

- With oil cold, ensure rams are in correct position by lowered bucket, turning steering to full left lock and if power swivel, turn bucket into the straight ahead position.
- Level is correct when visible in sight gauge (Fig 3).
- If no oil can be seen top up as required using approved hydraulic oil to (HV46) through filler cap (Fig 4, A).
- Do not overfill above sight gauge.

Check hydraulic oil filter indicator

- Check hydraulic filter indicator.
- If the RED button has 'popped out' (Fig. 4, B) the filter requires changing.

 Check hydraulic filter indicator with the oil HOT. Filter indicator may 'pop out' in extremely cold temperatures and should be reset..

WARNING - HOT FLUID

DO NOT attempt to remove the radiator cap until system has cooled down to avoid serious scalding.

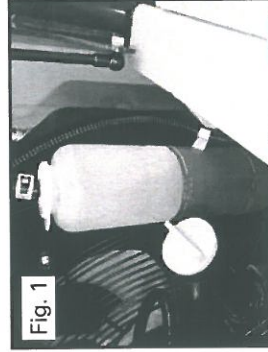

Fig. 1

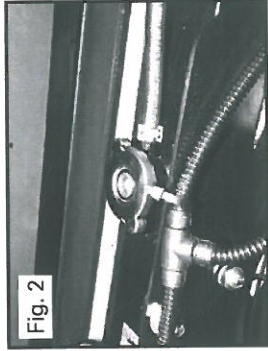

Fig. 2

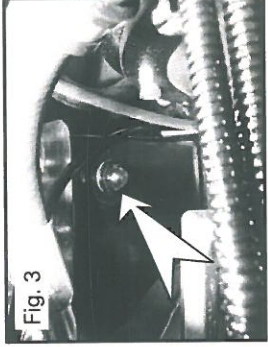

Fig. 3

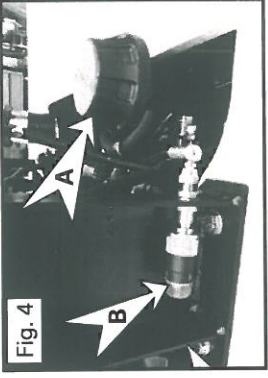

Fig. 4

CAUTION

It is imperative that hydraulic oil is clean to avoid damage to hydraulic components.

5 Daily (10 Hour) maintenance checks

Thwaites

Check brake functions

Note: Refer to section 1 of this manual for control layout.

Hand Brake

No regular maintenance is required. Check hoses for leaks.

 If leaks or damage is found do not operate the machine until the fault has been corrected.

Foot brake (Primary)

From the drivers seat, with your right foot press the brake pedal until resistance to movement is felt.

The pedal position should be no more than half way to the end of the slot in the floor plate.

 If pedal travel is excessive do not operate the machine until the fault has been corrected.

Steering wheel / column

Check the steering wheel for signs of damage (misshapen or broken). Hold the steering wheel push and pull to check for excessive movement in the steering column (Fig 1).

 If either is found do not operate the machine until the fault has been corrected.



Fig. 1

Check wheels and tyres

Check tyre pressures (Refer to data chart in section 4)

Check Air Cleaner Indicator

When window (Fig. 2) indicates RED, replace or clean filter as follows:

- Pull release clip (Fig. 3) and remove the end cup.
- Twist to remove primary element and secondary element (Fig. 4).
- Clean inside body.
- Refit or replace elements twist to ensure correct seating.
- Refit the end cup and secure clip.



CAUTION

DO NOT run engine with air cleaner removed.



Fig. 2



Fig. 3



Fig. 4

5 Weekly (50 Hour) maintenance checks

Thwaites

Check wheel nut torque

Check wheel nuts are in position and tight (330Nm)

Check Brake Oil Level

Brake master cylinder reservoir must be checked regularly. If oil level is low check system for leaks at all joints and pipes for damage. Top up to correct level with approved oil (Fig. 1).

Should brake reservoir need frequent additions of oil, machine **must not be used**. A thorough check of brake system must be carried out.

Note: Before removing filler cap clean area carefully to prevent contamination.

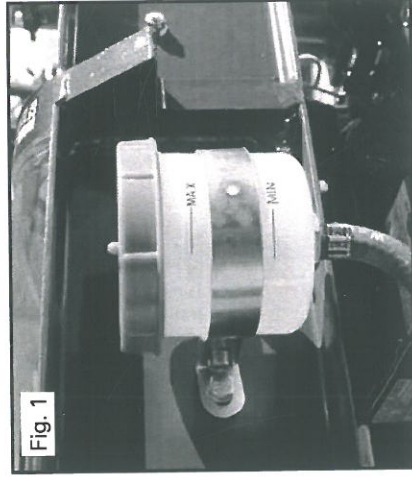

Fig. 1

Check Fan/Drivebelt Tension

- Isolate the battery (Fig. 2).
- Belt should have 10-15 mm of movement for correct tension (Fig. 3). (Refer to service manual for adjustment procedure)



WARNING

Isolate the battery before servicing, or making adjustments to the electrical system.

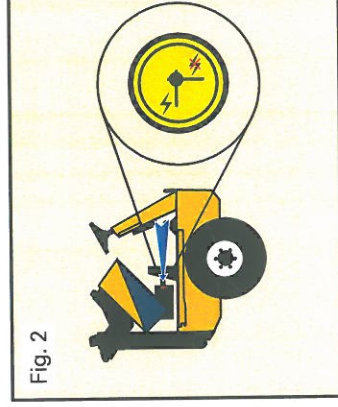

Fig. 2

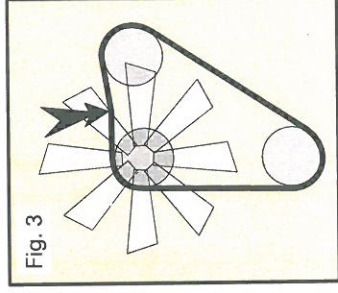

Fig. 3

5 Weekly (50 Hour) maintenance checks

Thwaites

Lubricate all grease points:

Apply grease to the following points provided around the machine to improve operation of moving parts:

1. Steering cylinder
2. Tipping cylinder
3. Kinglink assembly
4. Skip pivot pins
5. Propshafts
6. Engine cover hinges
7. Folding ROPS frame pins
8. Slew cylinders (Powerswivel Only)
9. Slew Ring (Powerswivel Only)
10. Central skip lock (Powerswivel Only)
11. Scissor frame pivot pins (Hi Swivel Only)

