Operation & Maintenance Manual

RUBBER CRAWLER CARRIER MST-1500VD

Serial No. 154501 and up

⚠ WARNING

Unsafe use of this machine may cause serious injury or death. Operators and maintenance personnel must read this manual before operating or maintaining this machine. This manual should be kept near the machine for reference and periodically reviewed by all personnel will come into contact with it.

MOROOKA

CONTENTS

ITEM	Page
FOREWORD	0- 1
1. Foreword	0- 2
2. Introduction	0- 3
3. Safety information	0- 4
4. Location of serial number	0- 5
SAFETY	1- 1
1. General precautions	1- 2
2. Precautions during inspection and maintenance	1- 4
3. Precautions before starting engine	1- 9
4. Precautions when starting engine	1-11
5. Precautions when traveling	1-12
6. Precautions for operation	1-15
7. Precautions for transportation	1-17
8. Position for attaching safety labels	1-18
OPERATION	2- 1
1. General view	2- 2
1.1 General view of machine	2- 2
1.2 General view of operator's compartment	2- 3
1.3 General view of control panel box	2- 4
1.4 General view on cab ceiling	2- 5
2. Explanation of components	2- 6
2.1 Meters and lamps on control panel box	2- 6
2.2 Monitor display	2- 8
2.3 Switches and levers on control panel box	2-10
2.4 Switches on cab ceiling	2-12
2.5 Warning devices	2-13
2.6 Travel lever	2-14
2.7 Dump control lever	2-16
2.8 Dump body safety bar	2-16
2.9 Air conditioner	2-17
2.9.1 Location of vents	2-17
2.9.2 Controls	2-17
2.9.3 Operation of air conditioner	2-18
2.9.4 Efficient use of air conditioner	2-19
2.10 Radio	2-20
2.10.1 Basic operations	2-21
2.10.2 Radio operations	2-22
2.10.3 Aux function	2-23
2.11 Fuse box in control panel box	2-24
2.12 Fuse box in cab at rear right portion	2-25
2.13 Fuses inside wiring harness and circuit breaker at battery	2-26

ITEM	Page
2.14 Operator' seat	2-27
2.15 Seat belt	2-29
2.16 Window shield	2-30
2.16.1 Opening and closing cab door	2-30
2.16.2 Opening and closing right window inside cab	2-31
2.16.3 Opening and closing rear window inside cab	2-31
2.17 Accessories inside cab	2-32
2.18 Engine inspection cover	2-33
2.19 Battery inspection cover	2-33
2.20 Front grill	2-33
2.21 Undercover	2-33
3. Operation	2-34
3.1 Check before starting engine	2-34
3.2 Operations and checks before starting engine	2-37
3.3 Starting engine	2-38
3.4 Moving machine off	2-41
3.5 Shifting speed range, changing between FORWARD and REVERSE	2-42
3.6 Steering machine	2-44
3.7 Stopping machine	2-46
3.8 Emergency stopping machine	2-46
3.9 Parking machine	2-47
3.10 Stopping engine	2-47
3.11 Checks after stopping engine	2-48
3.12 Locking	2-48
3.13 Precautions when traveling	2-49
4. Handling dump body	2-50
4.1 Dumping operation of dump body	2-50
4.2 Locking dump control lever	2-50
4.3 Operating safety bar	2-51
4.4 Precautions during operation	2-52
5. Manual release parking brake	2-53
5.1 Outline of parking brake	2-53
5.2 Method for manual release of parking brake	2-53
6. Handling rubber crawler	2-55
6.1 Features of rubber crawler	2-55
6.2 Prohibited operations for rubber crawler	2-55
6.3 Precautions when using rubber crawler	2-56
7. Transportation	2-57
7.1 Loading, unloading work	2-57
7.2 Precautions for loading	2-57
7.3 Precautions for transportation	2-57

ITEM	Page
8. Cold weather operation	2-58
8.1 Precautions for low temperature	2-58
8.2 After completion of work	2-59
8.3 After cold weather	2-59
9. Long-term storage	2-60
9.1 Before storage	2-60
9.2 Precautions during storage	2-60
9.3 Precautions after storage	2-60
10. Handling battery	2-61
10.1 Precautions when handling battery	2-61
10.2 Removal and installation of battery	2-62
10.3 Precautions when charging battery	2-62
10.4 Starting engine with booster cable	2-63
11. Troubleshooting	2-64
11.1 Problems with engine related parts	2-64
11.2 Problems with chassis related parts	2-65
11.3 Problems with electric related parts	2-66
MAINTENANCE	3- 1
1. Basic outline of maintenance	3- 2
2. Precautions for maintenance	3- 4
3. Use of fuel and lubricants according to ambient temperature	3- 6
3.1 Fuel, coolant, and lubricant table	3- 6
4. Tools and tightening torques	3-8
4.1 Introduction of necessary tools	3-8
4.2 Torque list for bolts and nuts	3-9
5. Periodic replacement of critical parts	3-10
5.1 Periodic replacement interval (every 2 years)	3-10
5.2 Periodic inspection	3-10
5.3 Specified periodic replacement parts	3-11
6. Maintenance schedule chart	3-12
7. Service procedure	3-14
7.1 Outline of inspection and maintenance procedures	3-14
7.2 Initial 100 hours service	3-14
7.3 Initial 500 hours service	3-14
7.4 When required	3-15
7.5 Check before starting	3-25
7.6 Every 50 hours service	3-30
7.7 Every 100 hours service	3-30
7.8 Every 250 hours service	3-31
7.9 Every 500 hours service	3-34
7.10 Every 1500 hours service	3-37

ITEM	Page
SPECIFICATIONS	4-1
1. Dimension drawing	4-2
2. Specifications table	4-3

FOREWORD

1. FOREWORD	0- 2
2. INTRODUCTION	0- 3
3. SAFETY INFORMATION	0- 4
4. LOCATION OF SERIAL NUMBER	0- 5

1. FOREWORD

Thank you for purchasing this Morooka Rubber Crawler Carrier.

This manual describes procedures for operation, handling, testing, and maintenance. It will help the operator realize many years of faithful service from the machine.

Please read this manual carefully BEFORE operating the machine. This will enable you to realize the peak performance of the machine.

For details of handling the engine, please see the separate engine operation manual for any item not given in this manual.

WARNING

- **Improper operation and maintenance of this machine can be hazardous and could result in serious injury or death.**
- **Operators and maintenance personnel should read this manual thoroughly before beginning operation or maintenance.**
Always keep this manual on the machine and be sure to read and understand it thoroughly before performing operation and maintenance.
- **Some actions involved in operation and maintenance of the machine can cause a serious accident if they are not done in the manner described in this manual.**
- **Keep this manual handy and have all personnel read it periodically.**
- **If this manual has been lost or has become dirty and cannot be read, request a replacement manual from Morooka or your Morooka distributor.**
- **If you lend this machine to another person, always have that person read the operation manual and make sure that they understand the content of the manual before starting operation. Be particularly careful to ensure that they follow the safety regulations when operating.**
- **Continuing improvements in the design of this machine can lead to changes in detail which may not be reflected in this manual. Consult Morooka or your Morooka distributor for the latest available information of your machine or for questions regarding information in this manual.**
- **The description of safety is given in SAFETY INFORMATION on page 0-3 and in SAFETY from page 1-1.**

2. INTRODUCTION

1. FEATURES OF THE MACHINE

- Low-ground-pressure rubber crawler type that can travel easily on uneven ground, soft ground, or snow.
- Long, wide rubber crawler to provide powerful and stable drawbar pull.
- Hydraulic drive (HST) to allow travel operations to be carried out with a single lever to give forward and reverse with stepless gear shifting, as well as turning and stopping.

2. BREAKING IN THE MACHINE

Your Morooka machine has been thoroughly adjusted and tested before shipment.

However, operating the machine under severe conditions at the beginning can adversely affect the performance and shorten the machine life.

Be sure to break in the machine for the initial 100 hours (as indicated by the hourmeter). Proper breaking in will allow the machine to give you many years of service.

During breaking in, pay particular attention to the following points.

- After starting the engine, idle it for 5 minutes to carry out the warming-up operation.
- Avoid operation with heavy loads or at high speeds.
- Avoid sudden starts, sudden acceleration, sudden steering and sudden stops except in cases of emergency.

3. WARRANTY

If any failure that is considered to be the responsibility of Morooka should occur within 6 months of delivery of the new machine or within 600 hours on the hourmeter, whichever comes sooner, repairs will be carried out free of charge in accordance with the warranty.

3. SAFETY INFORMATION

Most accidents are caused by the failure to follow fundamental safety rules for the operation and maintenance of machines.

To avoid accidents, read, understand and follow all precautions and warnings in this manual and on the machine before performing operation and maintenance.

Do not operate or carry out maintenance of this machine unless you are sure that you understand the explanations and procedures completely.

To identify safety messages in this manual and on machine labels, the following signal words are used.

DANGER

This word is used on safety messages and safety labels where there is a high probability of serious injury or death if the hazard is not avoided. These safety messages or labels usually describe precautions that must be taken to avoid the hazard. Failure to avoid this hazard may also result in serious damage to the machine.

WARNING

This word is used on safety messages and safety labels where there is a potentially dangerous situation which could result in serious injury or death if the hazard is not avoided. These safety messages or labels usually describe precautions that must be taken to avoid the hazard. Failure to avoid this hazard may also result in serious damage to the machine.

CAUTION

This word is used on safety messages and safety labels for hazards which could result in minor or moderate injury if the hazard is not avoided. This word might also be used for hazards where the only result could be damage to the machine.

NOTICE

This word is used for precautions that must be taken to avoid actions which could shorten the life of the machine.

Safety precautions are described in SAFETY from page 1-1.

Morooka cannot predict every circumstance that might involve a potential hazard in operation and maintenance.

Therefore the safety messages in this manual and on the machine may not include all possible safety precautions.

If any procedures or actions not specifically recommended or allowed in this manual are used, it is your responsibility to be sure that you and others can do such procedures and actions safely and without damaging the machine. If you are unsure about the safety of some procedures, contact your Morooka distributor.

4. LOCATION OF SERIAL NUMBER

On this machine, there is plate with the machine serial number stamped on it stuck to the left side surface of the travel lever stand inside the operator's compartment in the position in the diagram on the right.

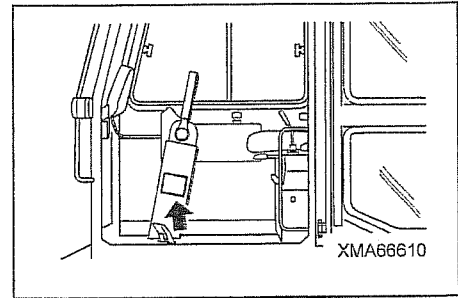

For the position of the engine serial number, please see the separate engine operation manual.

When inquiring about service or ordering parts, please quote the machine serial number, engine serial number, and hour-meter reading.

SAFETY

1. General precautions	1- 2
2. Precautions during inspection and maintenance	1- 4
3. Precautions before starting engine	1- 9
4. Precautions when starting engine	1-11
5. Precautions when traveling	1-12
6. Precautions during operation	1-15
7. Precautions for transportation	1-17
8. Position for attaching safety labels	1-18

WARNING

Read and follow all safety precautions. Failure to do so may result in serious injury or death.

This safety section also contains precautions for optional equipment and attachments.

1. GENERAL PRECAUTIONS

SAFETY RULES

- Only trained and qualified personnel, or personnel authorized by the company (or superior) can operate and maintain the machine.
- Follow all safety rules, prohibitions, precautions, procedures, and instructions when operating or performing maintenance on the machine, and pay careful attention to safety.
- Operating the machine when you are not in good physical condition reduces the power of judgment needed to avoid danger and leads to accidents.
People in the following conditions should not operate the machine.
 - People who cannot operate normally because they are tired, ill, or suffering from the effects of medication.
 - People who have been drinking.
 - Pregnant women



XMA00030

SAFETY FEATURES

- Be sure that all guards and covers are in their proper position. Have guards and covers repaired if damaged.
- Use safety features such as safety lock levers and seat belts properly.
- Improper use of safety features could result in serious bodily injury or death.
 - ★ Parking brake switch : See "OPERATION 3.9 PARKING MACHINE".
 - ★ Dump control lever lock : See "OPERATION 4.2 LOCKING DUMP CONTROL LEVER".
 - ★ Seat belt : See "OPERATION 2.15 SEAT BELT".

WEAR SUITABLE CLOTHING

- Always wear properly fitting clothes which allow ease of movement. If there are buttons, always button the cuffs.
- Avoid loose clothing, towels, jewelry, and loose long hair. They can catch on controls or in moving parts and cause serious injury or death.
- Also, do not wear oily clothes, they can easily catch fire.
- Wear a hard hat, safety glasses, non-slip safety shoes, and gloves when operating or maintaining the machine.

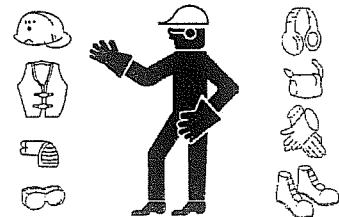

A0055010

FIRE EXTINGUISHER AND FIRST AID KIT

- Be sure that fire extinguishers have been provided and read the labels to ensure that you know how to use them.
- Provide a first aid kit at the storage point.
- Know what to do in the event of a fire.
- Be sure that you know the phone numbers of persons you should contact in case of an emergency.



A0055070

UNAUTHORIZED MODIFICATION

- Any modification made without authorization from Morooka can adversely affect the performance of the machine, and may also create hazards.
- Before making a modification, consult your Morooka distributor. Morooka will not be responsible for any injury or damage caused by any unauthorized modification.

FIRE PREVENTION FOR FUEL, OIL, AND ANTIFREEZE

Fuel, oil, and antifreeze can be ignited by a flame. Fuel is particularly flammable and can be hazardous.

- Use well-ventilated areas for adding or storing oil and fuel.
- Keep oil and fuel in the determined place and do not allow un authorized persons to enter.
- Tighten all fuel and oil caps securely.
- Keep any flame away from flammable fluids.
- Do not leave any cloths or rags soaked in oil or fuel lying in the fuel or oil storage area. Clean such materials up immediately.
- Stop the engine and do not bring lighted cigarettes or cigarette lighters close when refueling.



A0055020

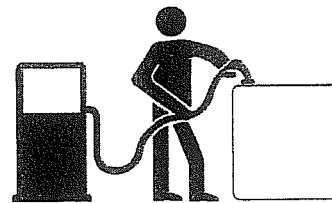

A0055030

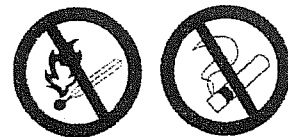

A0055040

USE HANDRAILS AND STEPS FOR GET ON OR OFF

Get on or off the machine as follows.

- Never jump on or off the machine. Never get on or off a moving machine.
- When getting on or off the machine, always face the machine and use the handrails and steps.
- To ensure safety, always maintain three-point contact with the handrails and steps to ensure that you support yourself.
- If there is any oil, grease, or mud on the handrails or steps, wipe it off immediately. Always keep these parts clean.

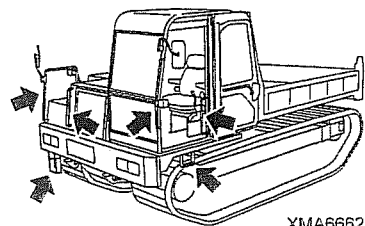

XMA66620

2. PRECAUTIONS DURING INSPECTION AND MAINTENANCE

NO UNAUTHORIZED PERSONS

Never allow unauthorized persons into the area when carrying out inspection and maintenance.
When leaving the operator's seat to carry out operations, hang a "DO NOT OPERATE!" sign (Part No.: 1-41010-1210) on the control lever to prevent any other person from operating the machine.

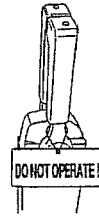

XMA52630E

USE SUITABLE TOOLS

Always use tools that are designed for the purpose. Do not use broken or deteriorated tools, or tools that are designed for other purposes.



A0055120

STOP ENGINE WHEN INSPECTION AND MAINTENANCE

When carrying out inspection and maintenance, always follow the precautions below.

- Select firm, level ground to park the machine.
- Lower the dump body, apply the parking brake, then stop the engine.
- Check that the travel lever is at the N position.
- If the engine must be started to carry out inspection or maintenance, take steps to ensure that the engine can be stopped at any moment.
- When carrying out the operation with two or more workers, determine the order of operation and fix signals, and follow the instructions of the person in charge.

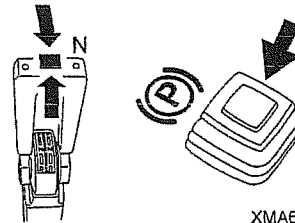

XMA66630

ALWAYS KEEP MACHINE CLEAN

Always do the following to keep the machine clean.

- Always keep the floor, steps, and handrails free of oil, grease, mud, or water. There is danger that you may slip and be injured. Always wipe off any oil, grease, mud or water.
- Do not leave tools or parts lying around on the floor or steps. There is danger that you may trip over them. Always clear up tools and parts immediately.
- Dry wood chips, leaves, grass, paper, oil, and other flammable materials around the engine, muffler, battery, or hydraulic tank may cause fire. Always remove any flammable objects and wipe off any oil.
- Always remove any mud accumulated around the undercarriage. There is danger that you may slip and fall when stepping on to the rubber crawler.

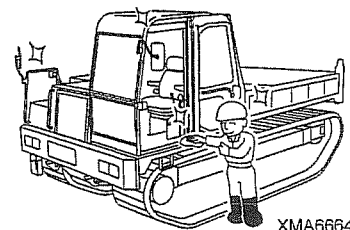

XMA66640



A0055020

VENTILATION FOR ENCLOSED AREAS

Exhaust fumes from the engine can kill.

- If it is necessary to start the engine within an enclosed area, open the doors and windows to provide adequate ventilation.

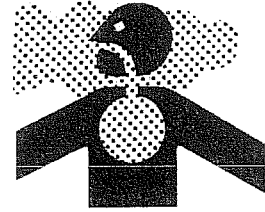

A0055060

KEEP AWAY FROM ROTATING AND MOVING PARTS

- Do not go close to the fan when it is rotating. Do not bring anything that can be caught up in the fan close to the fan.
- Do not come close to the dump body when it is moving. There is danger of getting caught or crushed.

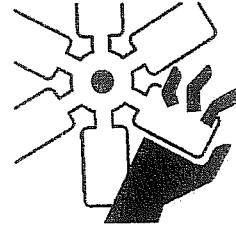

A0055210

KEEP AWAY FROM FLAME WHEN ADDING FUEL

When filling the fuel tank with fuel, or when draining the water, always follow the precautions below.

- Stop the engine.
- Do not bring any lighted cigarette or cigarette lighter close to the fuel tank.
- After adding fuel, tighten the cap securely and wipe up any spilled fuel.
- Do not bend the fuel hose or hit it with any sharp object.
- If any hose is loose or damaged, always repair or replace it.



A0055020

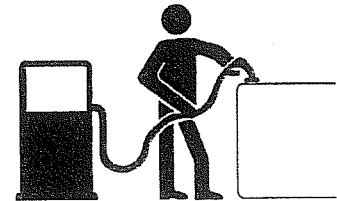

A0055030



A0055040

DO NOT TOUCH HIGH-TEMPERATURE, HIGH-PRESSURE PARTS IMMEDIATELY AFTER STOPPING ENGINE

Immediately after stopping the engine, many parts are at high temperature or under high pressure. If parts are removed or touched carelessly, there is danger of burns or other injury.

For the following parts particularly, always wait for the machine to cool down before inspecting.

- Radiator and radiator cap
- Hydraulic tank and hydraulic hoses
- Muffler and all parts of engine.

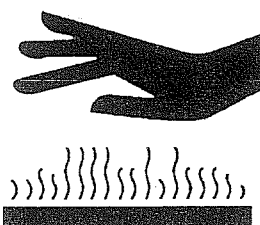

A0055050

WAIT FOR ENGINE TO COOL BEFORE CHANGING ENGINE OIL

When changing the engine oil, always follow the precautions below.

- Stop the engine and wait for the engine and oil temperature to go down before changing the oil.
- After adding oil, tighten the cap and drain valve securely and wipe up any oil that was spilled.

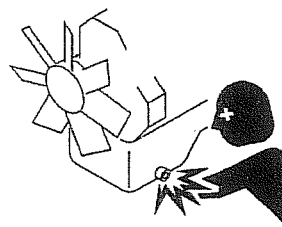

XMA00080

WAIT FOR WATER TEMPERATURE TO GO DOWN BEFORE ADDING COOLANT

Do not add water to the radiator.

Always follow the precautions below.

- Stop the engine and wait for the water temperature to go down.
- Turn the radiator cap slowly to release the internal pressure completely, then remove the cap.
- After adding water, tighten the cap securely and wipe up any water that was spilled.

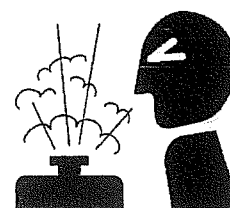

XMA05740

WAIT FOR PRESSURE TO GO DOWN BEFORE ADDING HYDRAULIC OIL

When adding oil to the hydraulic tank or when changing the oil, always follow the precautions below.

- Lower the dump body and stop the engine.
- Loosen the hydraulic tank cap slowly to release the internal pressure completely, then remove the cap.
- After adding oil, tighten the cap and drain plug securely and wipe up any oil that was spilled.

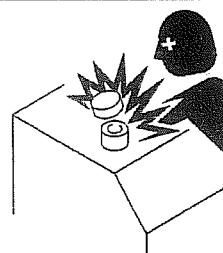

XMA00110

TAKE CARE WHEN HANDLING HIGH PRESSURE HOSES

Remember that oil is always flowing under high pressure in the hydraulic hoses. Do not remove the hoses before the internal pressure has been released.

When handling the high-pressure hoses, always follow the precautions below.

- Do not bend the high-pressure hoses or hit them with any sharp object.
- If any hose is loose or damaged, repair or replace it.
- It is extremely dangerous if oil is leaking from even small holes in the hoses or hydraulic equipment. If such a problem occurs, please contact your Morooka distributor.

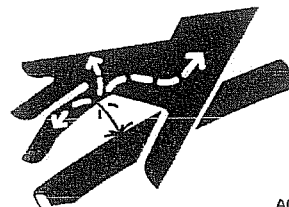

A0055180

BE CAREFUL OF HIGH-PRESSURE GREASE WHEN ADJUSTING RUBBER CRAWLER ATTENTION

The rubber crawler tension adjuster is filled with grease. The grease is kept under high pressure by the recoil spring inside the tension adjuster.

Always follow the precautions below when adjusting the tension. If these precautions are not followed, the valve may fly out and cause serious injury.

- Do not loosen the tension adjustment valve more than one turn. There is danger that the valve may fly out.
- When adjusting the tension, do not stand directly in front of the valve; stand to the side to avoid danger.

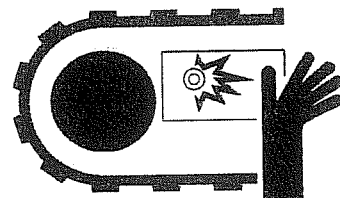

XMA00121

USE SAFETY BAR UNDER DUMP BODY

When going under the dump body to carry out operations, always follow the precautions below.

- Hang a "DO NOT OPERATE !" sign (Part No.: 1-41010-1210) in the operator's compartment to prevent any one else from operating the machine.
- Apply the lock of the dump control lever to prevent the truck box from lowering when the lever is touched inadvertently by an unauthorized person.
 - ★ Dump control lever lock: See "OPERATION 4.2 LOCKING DUMP CONTROL LEVER OPERATING".
- Always use the safety bar when going under the dump body.
 - ★ Safety bar: See "OPERATION 4.3 OPERATING SAFETY BAR".

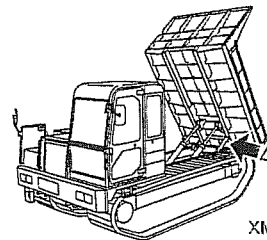

XMA66650

BE CAREFUL WHEN HANDLING BATTERY

• When checking or repairing the electrical system, always remove the negative (-) terminal from the battery to stop the flow of electricity. Failure to do this may cause fire or short circuit.

• Be careful not to get battery electrolyte on your skin or clothes. If the battery electrolyte gets on you, wash it off immediately with water.

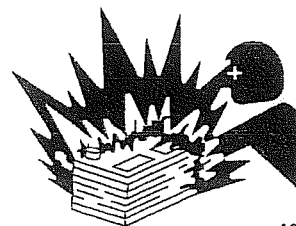

A0055170

DO NOT SPRAY WATER ON ELECTRICAL COMPONENTS

When washing the machine, do not spray water on the electrical components.

If water gets into the electrical system, it will cause defective operations which may lead to malfunctions.

Cover the following parts with a sheet to prevent water from getting on them.

- Instrument panel and control panel, switches, sensors, connectors
- Starting motor, alternator, sensors, connectors around the engine
- Battery, relay, connectors at front right of machine

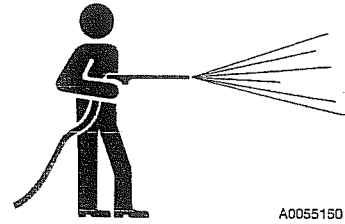

A0055150

DISPOSE OF WASTE MATERIAL CORRECTLY

- When draining and changing the oil, always put a container under the engine and tank to catch the oil.
- Do not drain the oil directly into the ground or throw it into rivers or the sewage system.
- When disposing of oil, fuel, coolant, solvent, filters, batteries, and other harmful objects, always use a suitable method or procedure.

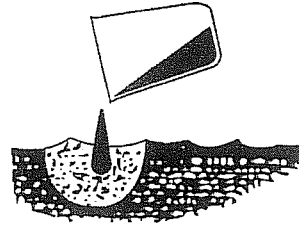

A0055220

3. PRECAUTIONS BEFORE STARTING ENGINE

ALWAYS CARRY OUT CHECKS BEFORE STARTING

Before starting the engine, always carry out the walk-around checks and inspections given in this manual.

- Check the ground under the machine to see if there is any trace of oil or water leakage.
- Be particularly careful to check the undercarriage for loose or missing nuts and bolts.
- If any abnormalities are found during the check, carry out simple repairs.

If the repairs are difficult, please contact your Morooka distributor.
The machine must not be used before repairs are carried out.

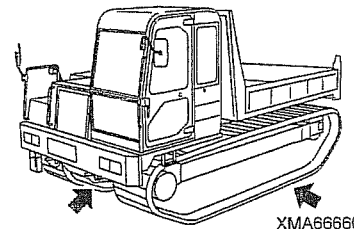

XMA66660

CHECK SAFETY PARTS AND LIGHTING

Check the operation of the following parts and devices needed for operation.

- Check that the horn, buzzer, and turn signal lamps work normally.
- Check that the front lamps light up normally.
- Check that the side mirrors are adjusted so that they give a clear view from the operator's seat.
- Clean the lights to ensure that they give good visibility.
- Adjust the operator's seat to a suitable position for operation.
Always adjust the seat if it has been used by another operator.
- Check that the seat belt can be locked properly.
Always adjust if it has been used by another operator.

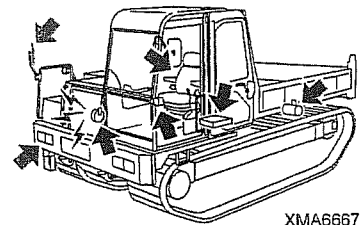

XMA66670

ALWAYS KEEP OPERATOR'S COMPARTMENT CLEAN

Always do the following to keep the operator's compartment clean and tidy.

- Always keep the floor, steps, and handrails free of oil, grease, mud, or water. There is danger that you may slip and be injured. Always wipe off any oil, grease, mud or water.
- Do not leave tools or parts lying around on the floor or steps. Keep these parts in the proper place to prevent them from obstructing operation.

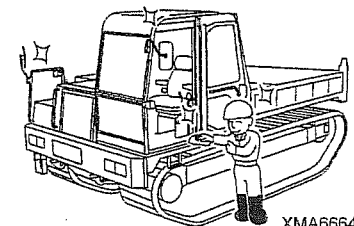

XMA66640

FIRE PREVENTION

- Completely remove all wood chips, leaves, grass, paper and other flammable materials accumulated in the engine compartment. They could cause a fire.
- Check fuel, lubrication, and hydraulic systems for leaks. Have any leaks repaired. Wipe up any excess oil, fuel or other flammable fluids.

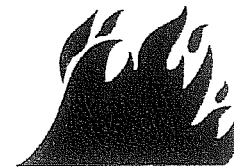

A0055020

VENTILATION FOR ENCLOSED AREAS

Exhaust fumes from the engine can kill.

- If it is necessary to start the engine within an enclosed area, open the doors and windows to provide adequate ventilation.

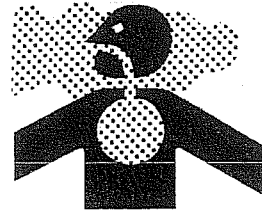

A0055060

SAFETY AT WORKSITE

Before starting operations, thoroughly check the area for any unusual conditions that could be dangerous.

- Check the terrain and condition of the ground at the worksite, and determine the best and safest method of operation.
- If there are any dangerous places, erect signs and take other steps to ensure safety.
- Check the depth and flow of water and the ground condition before operating in water or crossing a river. NEVER be in water which is in excess of the permissible water depth.
- If there are bridges or any other structure, check that they are of sufficient strength to support the weight of the machine.
- Inside the jobsite, do not allow any person other than the signalman to come close. Restrict the entry even of related workers.

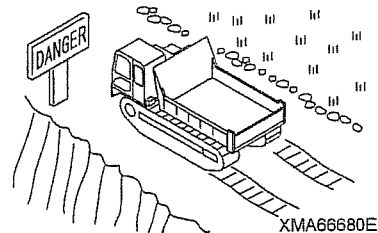

XMA66680E

4. PRECAUTIONS WHEN STARTING ENGINE

PLACE LEVERS AT NEUTRAL

Always place the levers at the following positions.

- Place the travel lever at the N position.
- Place the dump control lever at the HOLD position.
- Push the parking brake switch to the STOP position.
- Sit properly in the operator's seat and fit the seat belt.

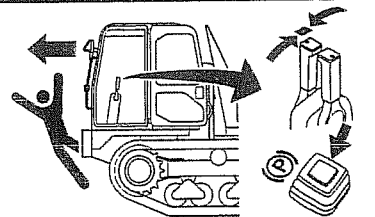

CHECK FOR SAFETY IN SURROUNDING AREA

Always check that there are no people in the surrounding area. Be particularly careful to check under the machine.

- Never start the engine if a warning tag has been attached to the controls.
- When starting the engine, sound the horn to warn people in the area.
- Do not allow anyone other than the operator to ride on the machine.

5. PRECAUTIONS WHEN TRAVELING

CHECK FOR SAFETY IN SURROUNDING AREA

Always check that there are no people in the surrounding area. Be particularly careful to check behind the machine.

- If the dump body is raised, always lower it.
- Sound the horn to warn people in the area that you are about to start the machine.

AVOID SUDDEN OPERATIONS EXCEPT IN EMERGENCIES

Do not suddenly start, suddenly stop, or suddenly turn the machine or carry out any other operation suddenly. Such operations may cause the crawler to come off and the machine to tip over.

- When starting or turning the machine, operate the travel lever slowly. Run the engine at low speed.
- Return the travel lever slowly to the N position. Apply the brake to stop the machine.
- If the travel lever is moved too far beyond the N position to the REVERSE (or FORWARD) position, the engine will run in reverse, or other problems will occur.
- Do not use the parking brake to stop the machine.
- If a dangerous state occurs by any possibility, and when it becomes necessary to stop the machine urgently, press the parking brake switch to set it to the STOP position or turn the engine starting switch to the OFF position to stop the engine.

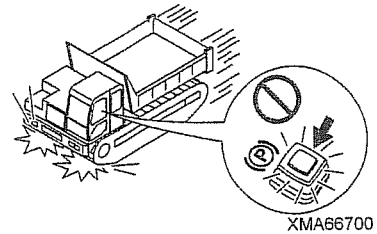

TRAVEL CAREFULLY ON UNEVEN GROUND OR ON CURVES

When traveling on uneven ground or in places where there are many curves, reduce the travel speed and travel carefully. If the machine is traveling at high speed it may turn over or crawler may come off.

NO TRAVELING ON PUBLIC ROADS

This machine is not permitted to travel on public roads.
When moving the machine, always transport it by truck or trailer.

BE CAREFUL OF ROAD SHOULDERS

When traveling on narrow agricultural roads, always follow the precautions below.

- Do not travel too close to the road shoulder, and travel at reduced speed.
- Do not travel on any soft road shoulder or place covered with grass.
- During or after rain, the danger of landslides and falling rocks increases. Always travel at low speed and check that the area is safe.

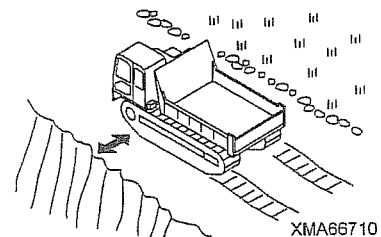

AVOID OBSTACLES

Avoid traveling over obstacles or earth embankments as far as possible. If the machine has to travel over an obstacle, do as follows. Never travel over large boulders, breakable objects, pieces of concrete, or other sharp objects.

- Reduce the travel speed and travel carefully.
- Steer the machine so that the center of the rubber crawler passes directly over the obstacle. Mount the obstacle slowly, and when the machine goes over the top and starts to tip forward, stop the machine. Then slowly start the machine again. Never change direction when doing this.
- Earth embankments may collapse under the weight or vibration of the machine and cause the machine to slip, so drive the machine slowly and do not change speed or direction. Be particularly careful when traveling over freshly dug ditches. They may collapse.

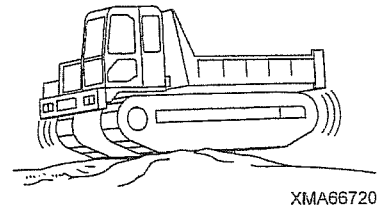

XMA66720

TRAVELING ON SLOPES

When traveling on hills or slopes, always follow the precautions below.

- Do not travel at an angle on a hill or slope, or parallel to the slope. Such action could result in the machine tipping over or slipping.
- When traveling up hills or slopes, always travel directly up the slope. Set the travel speed to a low range and keep the travel lever close to the N position (low speed).
- Do not suddenly change speed on the slope. There is danger that the direction of the machine may suddenly change and the machine may slip.
- When traveling down slopes, set the travel speed to a low range, run the engine at low idling, and operate the travel lever to a position less than 1/2 of the full stroke from the N position. If the machine travels too fast, there is danger that the engine will overrun and the machine may slip.
- Do not travel on grass, fallen leaves, wet steel plates, or other slippery objects.
- If a dangerous state occurs by any possibility, and when it becomes necessary to stop the machine urgently, press the parking brake switch to set it to the STOP position or turn the engine starting switch to the OFF position to stop the engine.

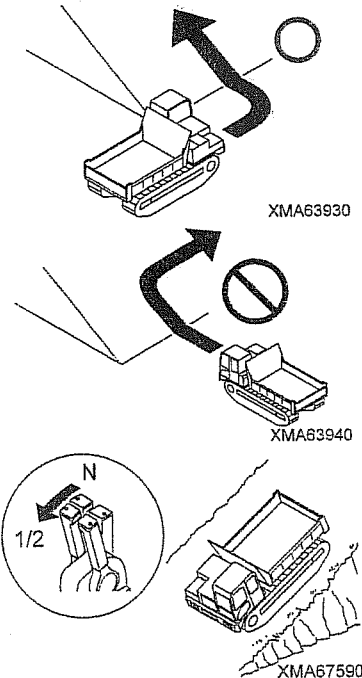

XMA63930

XMA63940

XMA67590

ENSURE GOOD VISIBILITY

When working in dark places or at night, turn on the head lamps. Turn on the lights in mist, snow, or rain.

OPERATE CAREFULLY ON SNOW

- When working on snow or icy roads, even a slight slope may cause the machine to slip to the side, so always travel at low speed and avoid sudden starting, stopping, or turning.
- When there has been heavy snow, the road shoulder and objects placed beside the road are buried in the snow and cannot be seen, so always carry out operations carefully.

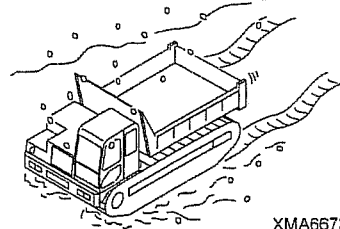

XMA66730

PARKING MACHINE

Park the machine on firm, level ground. Select a place where there is no problem of falling rocks, landslides, or floods.

If the machine has to be parked on a slope, do as follows.

- Stop the machine facing directly up or down the slope.
- Always put blocks under the tracks to prevent the machine from moving.
- Lower the dump body fully.

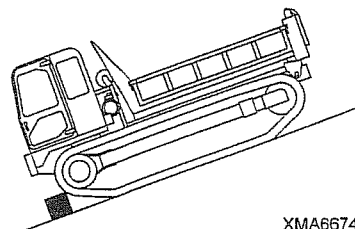

XMA66740

REMOVE KEY WHEN LEAVING MACHINE

When leaving the machine, always do as follows.

- Lower the dump body fully.
- Apply the parking brake, then stop the engine.
- Lock the dump control lever.
- Remove the starting key and always take it with you.

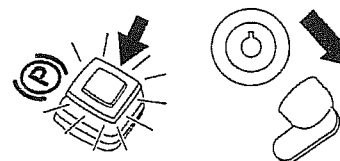

XMA66750

6. PRECAUTIONS FOR OPERATION

USE SIGNALS

When carrying out work with one or more workers, or when using a signalman, determine the signals and the person in charge before starting work, and always follow the agreed procedure.

Even when using a signalman, always pay careful attention to the following.

- When working in confined spaces or indoors, be careful not to hit the surroundings or the ceiling.
- When operating in urban areas or on roads, put up fences around the jobsite and take steps to ensure the safety of passing traffic and pedestrians.

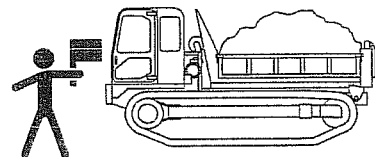

XMA66760

MAKE JOBSITE FLAT

Make the jobsite flat. This will not only increase the efficiency but will also ensure safety.

If the jobsite is dusty, spray water to ensure the visibility.

OPERATE DUMP BODY CAREFULLY

When carrying out dumping operations, be careful of the following.

- Check that there is no person or obstacle near the dump body.
- Stop the machine at the determined point and operate the dump in accordance with signals from the signalman.
- Block the tracks to prevent the machine from moving in reverse.
- When dumping on slopes, there is danger of the machine tipping over. If it is felt that there is danger to the machine, stop the operation immediately.

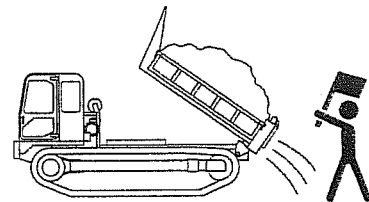

XMA66770

NO OVERLOADING

Never load the machine above its capacity.

Overloading will not only cause failures, but will also cause overrunning and tipping over on slopes.

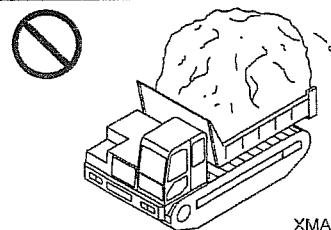

XMA66780

LOAD DUMP BODY EVENLY

- Do not load the dump body on one side. Always spread the load to maintain the balance in the dump body.
- When carrying long objects, such as timber or steel beams, give careful consideration to the position of the center of gravity of the load, and secure with ropes.
- When stacking U-shaped ditch liners or concrete blocks, lay a plate down first and secure with ropes to prevent the load from slipping.

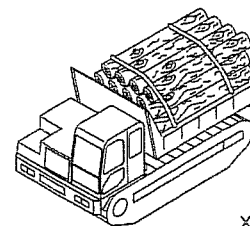

XMA66790

DO NOT GO CLOSE TO HIGH-VOLTAGE CABLE

When carrying out operations on jobsites where there are power cables, use a signalman and take steps to protect the electric cables. Check with the electricity company before starting operations.

- Going close to high-voltage cables can cause electric shock, even if the machine does not touch the cables. Always maintain the safe distance given below between the machine and the electric cable.

	Voltage of Electrical Cable	Minimum Safe Distance
Low voltage (Distribution line)	100 • 200V	2m
	6,600V	2m
Special (Transmission line)	22,000V	3m
	66,000V	4m
	154,000V	5m
	187,000V	6m
	275,000V	7m
	500,000V	11m

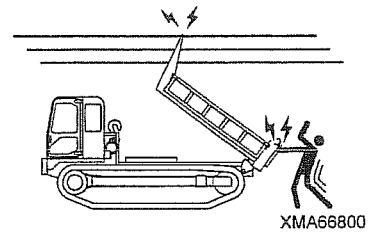

- If the dump body should touch the electric cable, the operator should not leave the operator's compartment. He should call another worker to report the situation. The following actions are effective in preventing accidents.
 - (1) Wear shoes with rubber soles.
 - (2) Use a signalman to give warning if the machine approaches too close to the electric cables.
- When carrying out operations near high-voltage cables, do not let anyone come close to the machine.

7. PRECAUTIONS FOR TRANSPORTATION

USE SAFE RAMPS

Always use ramps which fulfill the following conditions.

- Strong ramps which can fully support the weight of the machine.
- Ramps with a width greater than the width of the crawlers.
- Ramps of a length which will not form a steep angle when placed against the platform of the truck or trailer to be used for transportation.

If the ramps are too long and they bend excessively, use blocks to support the ramps as necessary.

- Ramps with hooks and non-slip surface.
- Be sure that the ramp surface is clean and free of grease, oil, ice and loose materials. Remove dirt from the machine tracks.

CORRECT

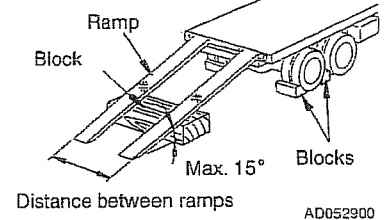

LOADING AND UNLOADING

Loading and unloading the machine always involves potential hazards. **EXTREME CAUTION SHOULD BE USED.**

Always do as follows

- Perform loading and unloading on firm level ground only.
- Stop the engine of the haulage truck, apply the parking brake securely, then block the tires.
- Set the ramps parallel and in line with the width of the crawlers.
- Fix the hooks of the ramps securely to the truck platform.
- Set the machine to be loaded in line with the ramps, then approach the ramps at low speed.
- Do not correct the direction of travel when on the ramps.

If it is necessary to change the direction, drive the machine off the ramps, and set the machine to the correct direction.

- After loading, put blocks under the front and rear of the crawlers to prevent the machine from moving, then tie the machine down with chains or wire rope.

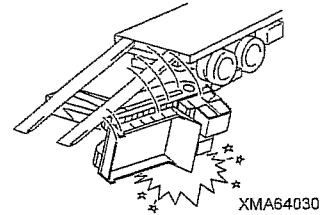

SHIPPING

- When shipping the machine on a hauling vehicle, obey all state and local laws governing the weight, width, and length of a load. Also obey all applicable traffic regulations.
- Take into account the width, height and weight of the load when determining the shipping route.

8. POSITION FOR ATTACHING SAFETY LABELS

Always keep these labels clean.

If they are lost or damaged, always attach them again or replace them with a new label.

There are other labels in addition to the safety labels listed as follows, so handle them in the same way.

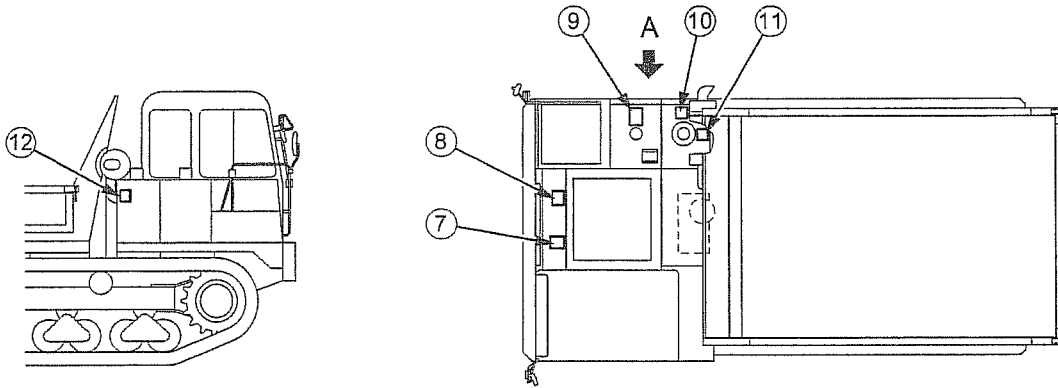

View A

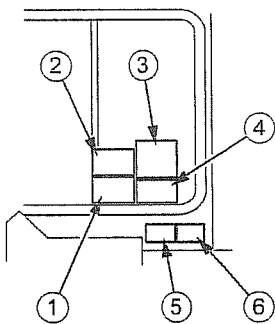
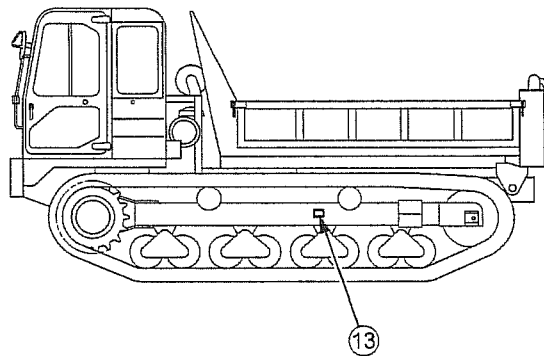
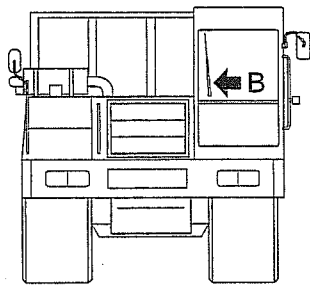

View B

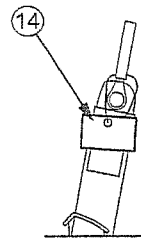

Travel Lever

XMA66810E

(1) Precaution for starting engine and leaving
(1-41010-1320)

⚠ WARNING

STARTING ENGINE AND MACHINE

- When starting engine, put the travel lever in the N position, and put parking brake lever or the switch in the STOP position.
- When traveling the machine, always put the parking brake lever or the switch in the RUN position.
- Ensure safety around the machine, sound the horn and start.
- DO NOT operate abruptly: this means no starting abruptly, stopping abruptly or turning abruptly. Operating abruptly may cause the track to disengage or cause the machine to fall over.

1-41010-1320

(2) machine Precautions when travelling downhill
(1-41010-1290)

⚠ WARNING

WHEN TRAVELLING DOWN SLOPES

- When travelling down slopes, reduce the engine speed before traveling on slopes, adjust the travel level throttle, and travel down the slope at low speed.
- DO NOT travel across or parallel slopes. The machine may overturn sideslips.
- NEVER travel down slopes at engine speed more than the rated engine speed. This may overturn and dangerous slipping.

1-41010-1290

(3) Precautions when operation (1-41010-1330)

⚠ WARNING

- Before operating the machine read the Operation & Maintenance Manual carefully.
- Take extra care when traveling on uneven ground or oval-shaped ground. Depending on the track tension, this may cause the track to disengage or the machine to damage.
- Always check if there are stones clogged around the inks before starting.
- When entering under the dump body for checking, always use the safety bar to prevent the dump body lowering.
- Always dump the load on the level, hard ground.
- When leaving the operators seat, put the travel lever in the N position, and put the parking brake or the switch in the STOP position.
- DO NOT use the parking brake as the service brake except in an emergency.
- When leaving the machine, always take the key.

1-41010-1330

(4) Caution for periodic replacement parts
(1-12020-1210)

⚠ CAUTION

Replace the following parts periodically.

Periodic replacement parts	Replacement interval
Fuel hose (from fuel tank to fuel injection pump)	Every 2 years
Fuel hose (from fuel injection pump to fuel tank)	
Hydraulic hose (from main pump to travel motor)	
Hydraulic hose (from gear pump to main control valve)	
Hydraulic hose (from dump control valve to dump cylinder)	
Hydraulic hose (between left and right dump cylinder)	Every 3 years
Seat belt	

1-12020-1210

(5) Precautions when fitting seat belt
(1-41010-1310)



⚠ WARNING

SEAT BELT

- Always fasten the seat belt during operation.

1-41010-1310

(6) Precautions for warming-up operation
(1-41010-1230)

⚠ CAUTION

WARMING-UP

- This machine must be properly warmed up, or the equipment will operate abnormally or unexpectedly, and may be damaged.

1-41010-1230

(7) Beware of high-temperature coolant
(1-41010-1300)

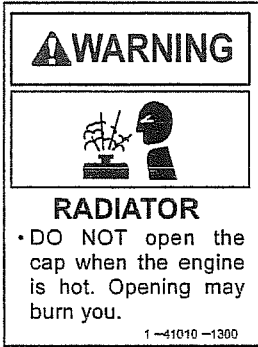

(8) Beware of rotating fan and pulley (1-41010-1260)

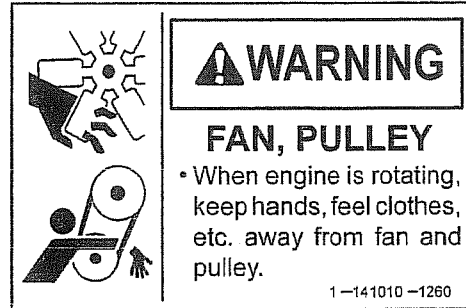

(9) Precautions when adding fuel (1-41010-1280) (10) Precautions for oil inside hydraulic tank
(1-41010-1250)

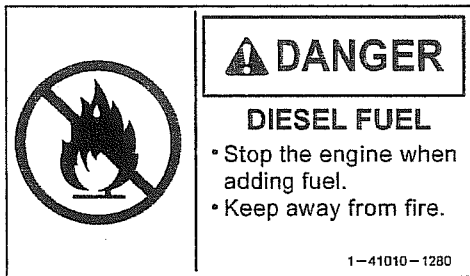

(11) Muffler is at high temperature (1-41020-1220) (12) Beware of rotating crawler (1-41010-1240)



(13) Precautions for crawler adjustment valve (1-41010-1270) (14) Warning tag to prevent operation during maintenance
(1-41010-1210)

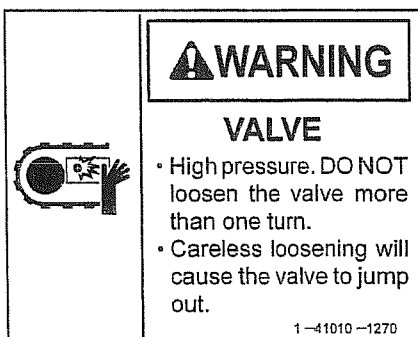

OPERATION

1. General view	2-2
2. Explanation of components	2-6
3. Operation	2-34
4. Handling dump body	2-50
5. Manual release of parking brake	2-53
6. Handling rubber crawler	2-55
7. Transportation	2-57
8. Cold weather operation	2-58
9. Long-term storage	2-60
10. Handling battery	2-61
11. Troubleshooting	2-64

1. GENERAL VIEW

1.1 GENERAL VIEW OF MACHINE

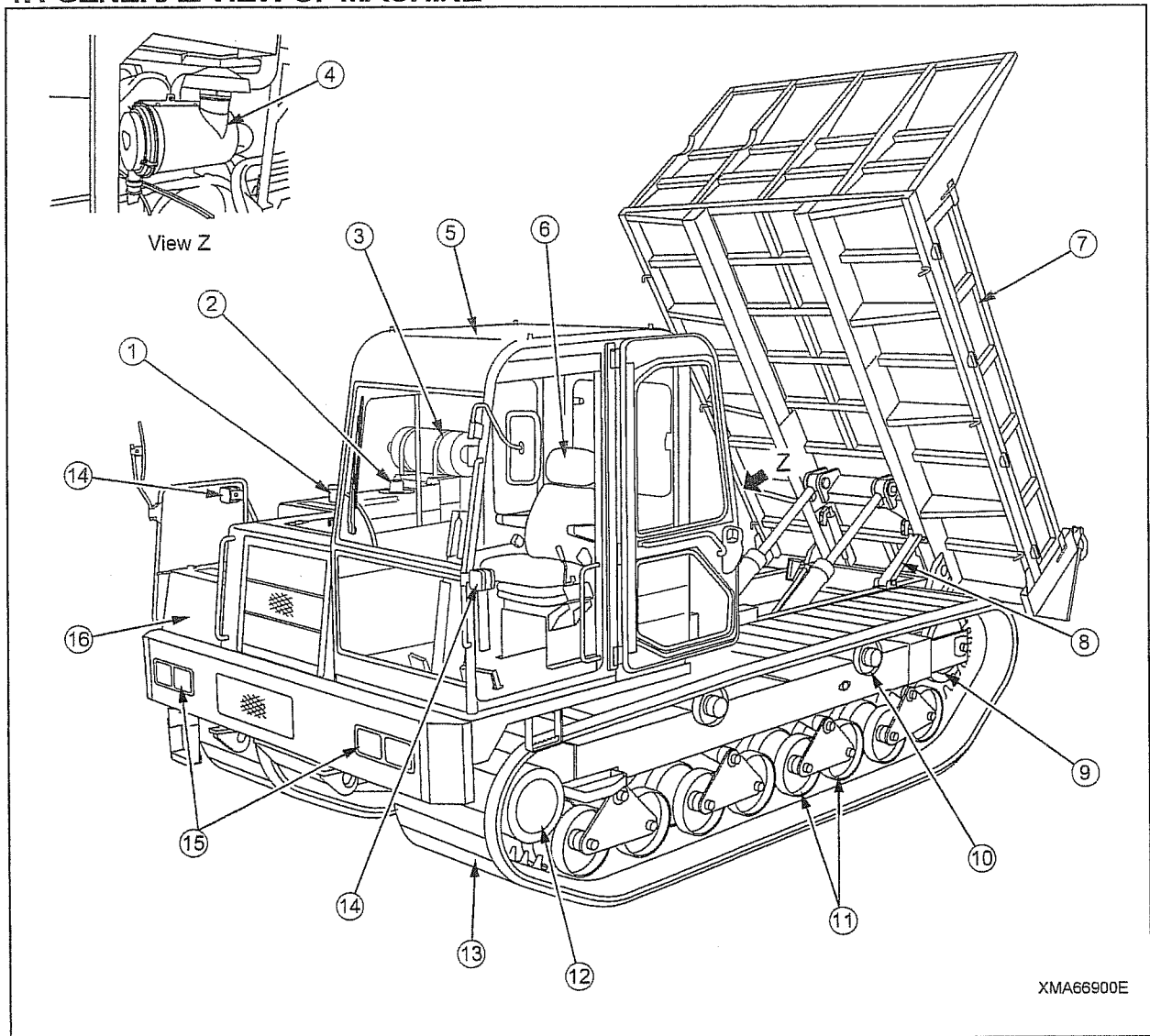

XMA66900E

- | | | |
|---------------------|-----------------------------|-----------------------|
| (1) Fuel tank | (7) Dump body | (13) Rubber crawler |
| (2) Hydraulic tank | (8) Safety bar | (14) Turn signal lamp |
| (3) Muffler | (9) Rear idler | (15) Head lamp |
| (4) Air cleaner | (10) Carrier roller | (16) Battery box |
| (5) Cab | (11) Track roller | |
| (6) Operator's seat | (12) Travel motor, sprocket | |

1.2 GENERAL VIEW OF OPERATOR'S COMPARTMENT

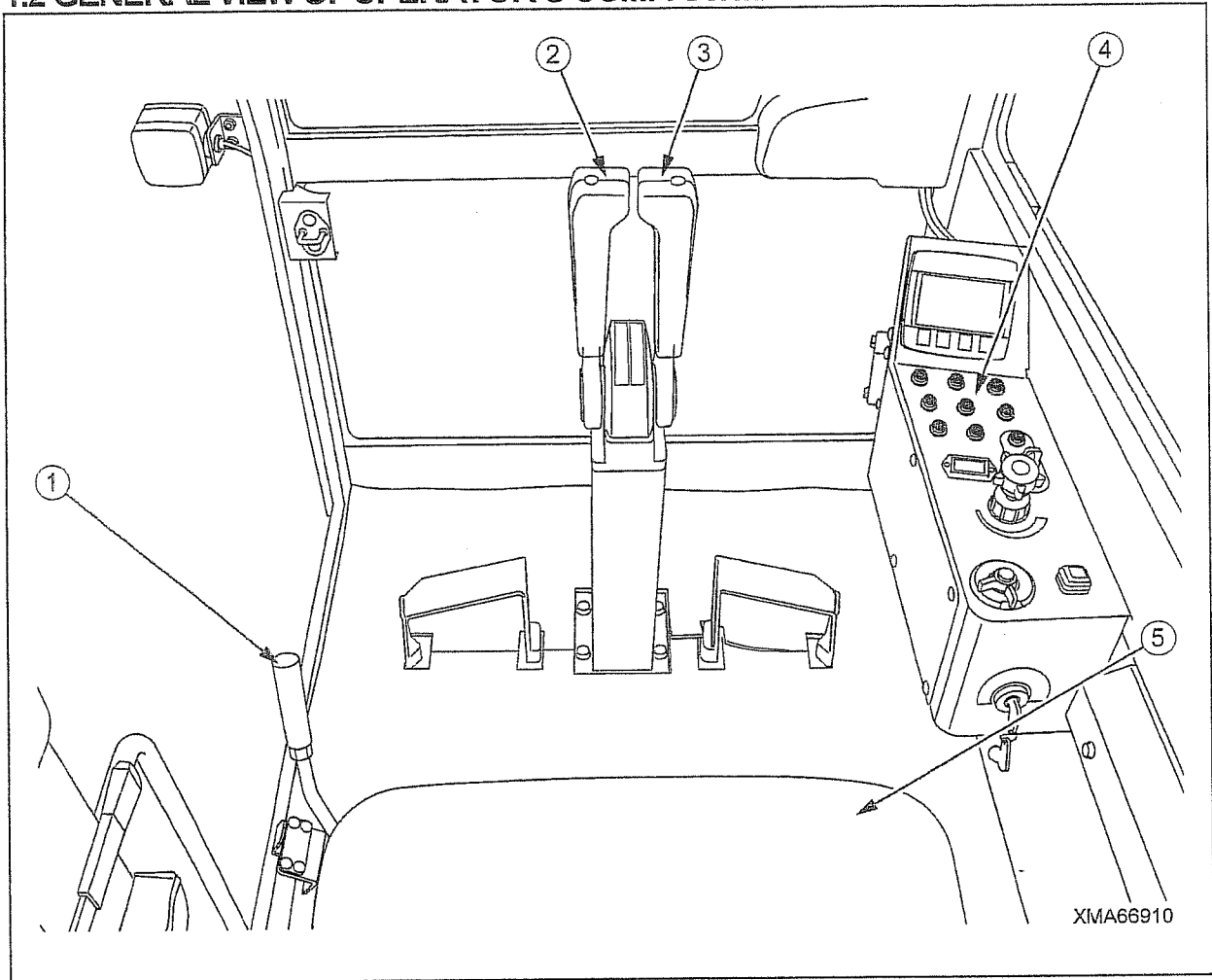

- (1) Dump control lever
- (2) Left travel lever
- (3) Right travel lever

- (4) Control panel box
- (5) Operator's seat

1.3 GENERAL VIEW OF CONTROL PANEL BOX

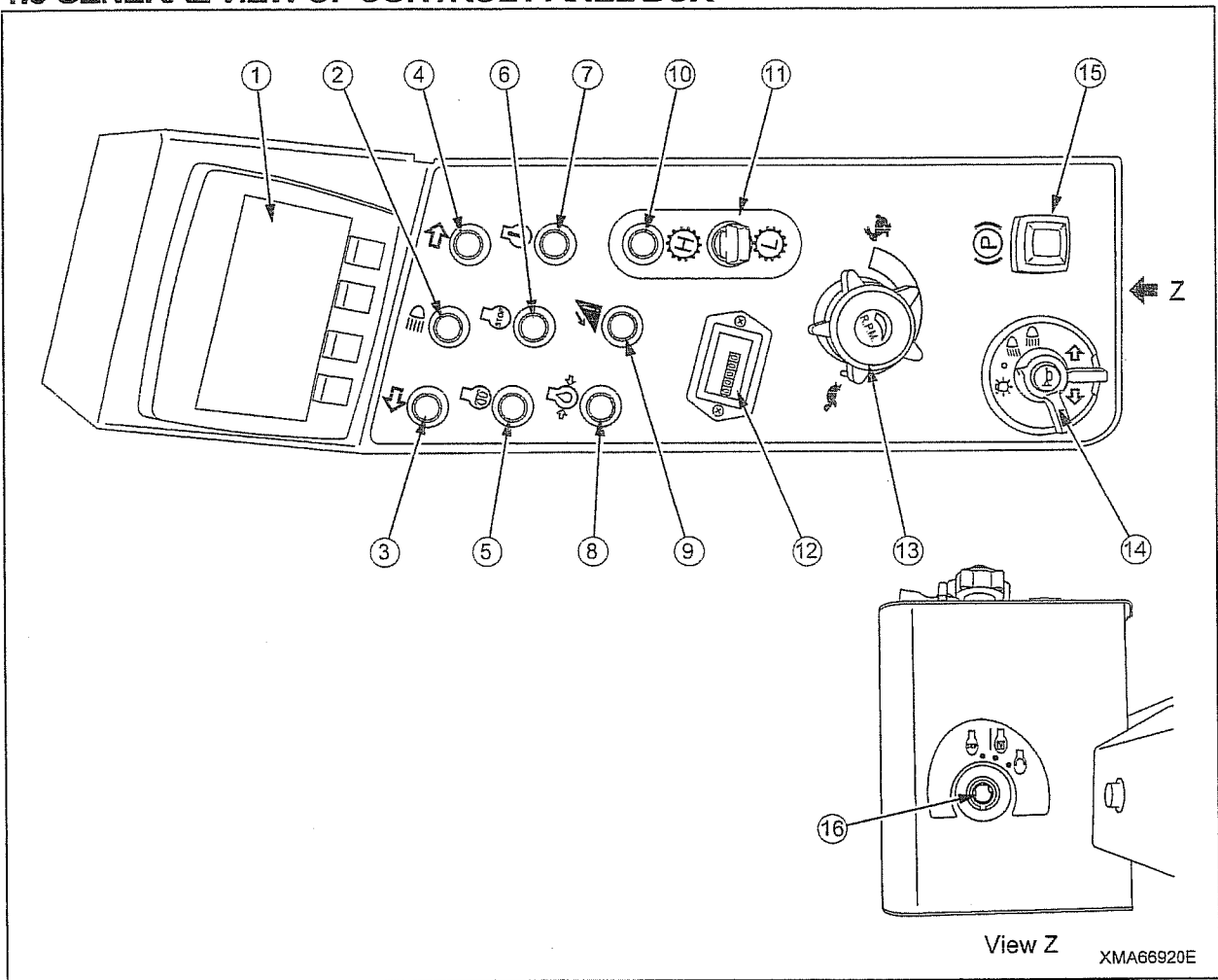

- | | |
|--|--|
| (1) Monitor display | (9) Slope caution lamp (Red) |
| (2) Head lamp high beam lamp (Blue) | (10) High speed pilot lamp (Green) |
| (3) Turn signal pilot lamp (Left) (Green) | (11) Hi-Lo speed range selector switch |
| (4) Turn signal pilot lamp (Right) (Green) | (12) Hourmeter |
| (5) Preheating indicator lamp (Orange) | (13) Engine speed control dial |
| (6) Engine warning lamp (Red) | (14) Combination switch |
| (7) Engine diagnostic lamp (Orange) | (15) Parking brake switch |
| (8) Engine oil pressure lamp (Red) | (16) Starter switch |

1.4 GENERAL VIEW ON CAB CEILING

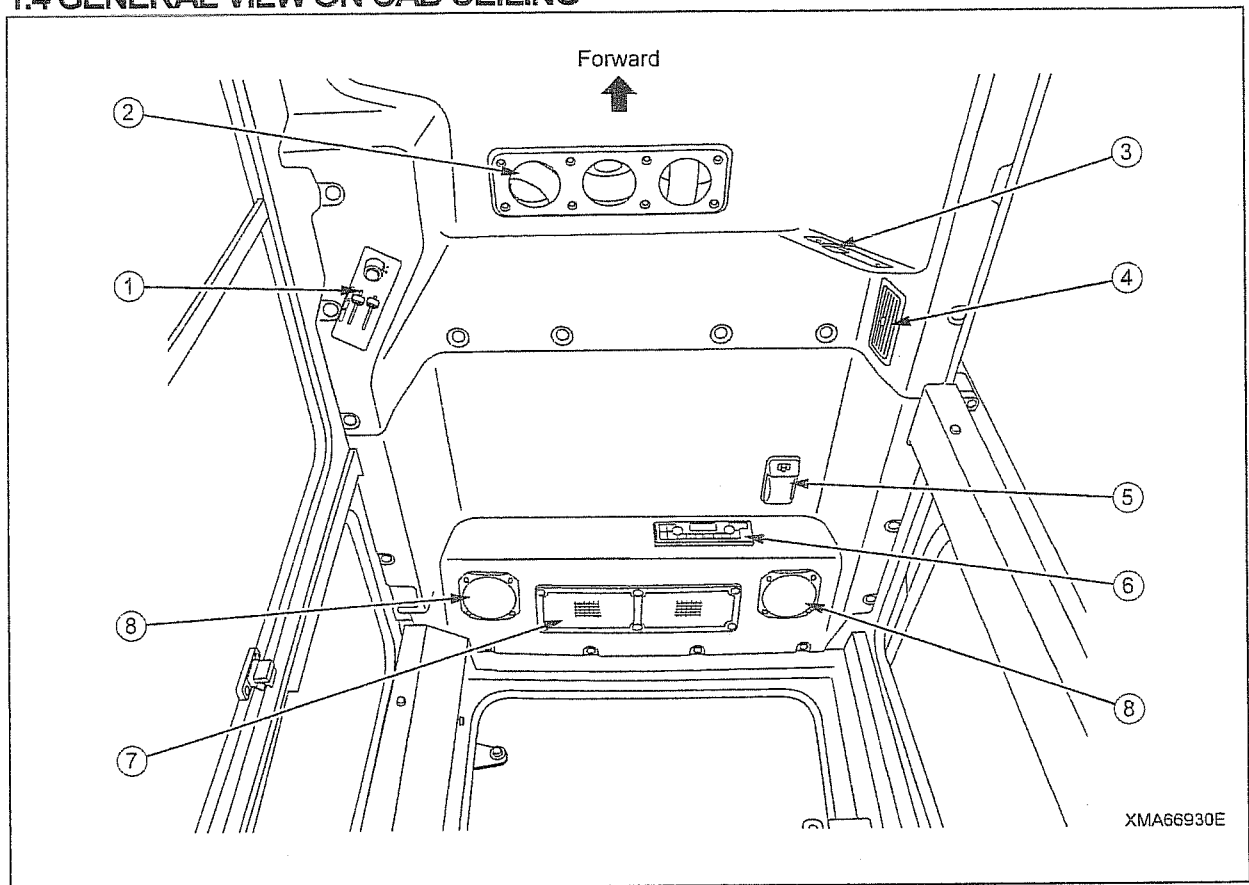

XMA66930E

- (1) Air conditioner control panel
- (2) Air vent
- (3) Wiper switch
- (4) Air vent

- (5) Room lamp (With switch)
- (6) Radio (AM/FM Stereo)
- (7) Air intake
- (8) Speaker

2. EXPLANATION OF COMPONENTS

The following is an explanation of devices needed for operating the machine.

To carry out suitable operations correctly and safely, it is important to understand fully the methods of operating the equipment and the meanings of the displays.

2.1 METERS AND LAMPS ON CONTROL PANEL BOX

[1] HOURMETER

This shows the total number of hours of the operation of the machine.

When the starting switch is at the ON position, the meter will advance even if the machine is not moving.

Use the hourmeter reading as the standard for periodic inspection and maintenance.

★ When you stop the engine, always turn the starting switch to the OFF position.

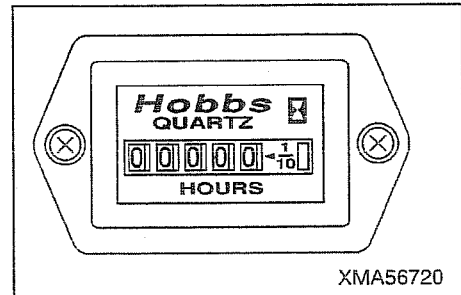

[2] OTHER LAMPS

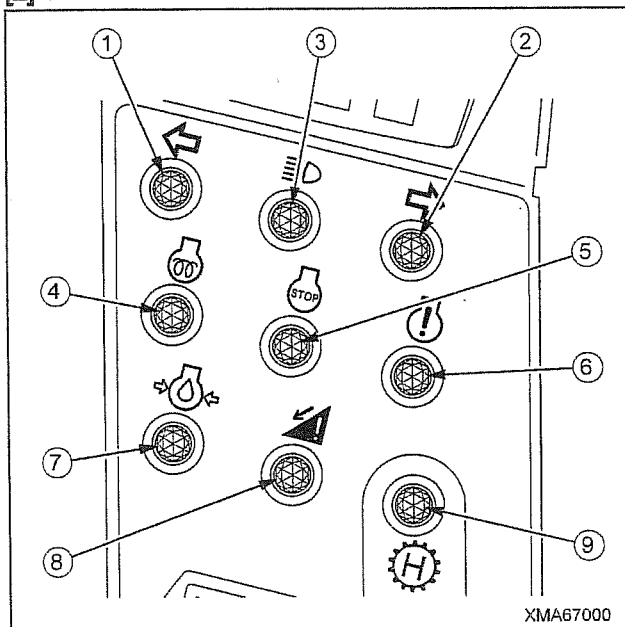

- (1) Turn signal pilot lamp (Left turn) (Green)
- (2) Turn signal pilot lamp (Right turn) (Green)
- (3) Head lamp high beam lamp (Blue)
- (4) Preheating indicator lamp (Orange)
- (5) Engine warning lamp (Red)
- (6) Engine diagnostic lamp (Orange)
- (7) Engine oil pressure lamp (Red)
- (8) Slope caution lamp (Red)
- (9) High speed travel lamp (Green)

(1), (2) TURN SIGNAL PILOT LAMP (Green)

This shows the operation of the turn signal switch in the combination switch.

When the turn signal switch is turned to LEFT side, the left side turn signal lamp and pilot lamp flashes.

When the turn signal switch is turned to RIGHT side, the right side turn signal lamp and pilot lamp flashes.

(3) HEAD LAMP HIGH BEAM LAMP (Blue)

This shows the operation of the light switch in the combination switch.

When the light switch is turned to HI BEAM, the high beam pilot lamp lights up.

(4) PREHEATING INDICATOR LAMP (Orange)

It indicates the engine preheating states. In cold weather conditions, the intake air heater starts automatically to preheat the intake air according to the condition of the intake air temperature and coolant temperature.

If you turn the starting switch to "ON/Preheat" and then engine intake air heater works, the lamp will light up, and when engine preheating is completed, the lamp will turn off.

(5) ENGINE WARNING LAMP (Red)

This warns the operator of engine abnormalities of the engine during its operation.

It should be out during operations.

If it lights up during operation, this indicates an abnormality has occurred in the engine.

- ★ If this lamp lights up, stop the engine immediately and contact your distributor. The reduced hydraulic pressure of the engine, increased coolant temperature, reduced coolant level, or increased intake air temperature may be suspected.
- ★ When the starting switch is turned to the ON position, this warning lamp will light up to enable the function of the lamp to be checked and will go out after approximately two seconds. If the lamp goes out, the engine can be considered to be operating normally. Start the engine only after the lamp has gone out.
- ★ If the lamp does not go out, do not under any circumstances start the engine. In this case, contact your distributor immediately.

(6) ENGINE DIAGNOSTIC LAMP (Orange)

This lights up to inform the operator of the location of the engine failure during operation.

During operation, this lamp should be out.

If any abnormality occurs in the engine during operation, this lamp flashes. The location of the failure is identified by the number of times the lamp flashes.

- ★ If the lamp flashes, stop the engine immediately and contact your distributor.
- ★ When the starting switch is turned to the ON position, this warning lamp will light up to enable the function of the lamp to be checked and will go out after approximately two seconds. If the lamp goes out, the engine can be considered to be operating normally. Start the engine only after the lamp has gone out.
- ★ If the lamp does not go out, do not under any circumstances start the engine. In this case, contact your distributor immediately.

(7) ENGINE OIL PRESSURE LAMP (Red)

This warns the operator that the engine oil pressure has dropped.

It should be out during operations.

If it lights up during operations, the engine oil pressure has dropped.

Stop operations immediately and check for the cause.

- ★ Check the engine oil level. Check also for clogging of the engine oil filter.
- ★ If the inspection shows that there is no abnormality, please contact your distributor.

(8) SLOPE CAUTION LAMP (Red)

WARNING

If this lamp lights up when traveling downhill, the machine has exceeded the permissible range of the slope angle. To prevent the danger of overrun, carry out the following operations quickly and continue to travel downhill.

1. Return the travel lever to the N position and set the travel speed to a range where it does not naturally increase.
2. Operate the engine throttle lever to reduce the engine speed.
3. If the OVERRUN CARE lamp on the monitor panel lights up even when the above operation is carried out, it means that the machine is exceeding the safe travel speed. Stop the machine immediately and reduce the load on the dump body.

This lamp warns the operator that the machine has entered the danger zone for the angle of the slope.

If the machine exceeds the permissible slope angle (9 deg) when traveling, the slope alarm buzzer under the operator's seat will sound for 5 seconds and the monitor lamp will light up.

(9) HIGH-SPEED TRAVEL PILOT LAMP

This lights up to inform the operator that the machine is in the high speed travel range.

When the Hi-Lo speed range selector switch is set to the HIGH SPEED, the lamp lights up.

When the Hi-Lo speed range selector switch is set to the LOW SPEED, the lamp goes out.

2.2 MONITOR DISPLAY

⚠ WARNING

- When traveling uphill or downhill, be sure to regularly check the tachometer to ensure the engine is running at an appropriate speed. In particular, when traveling downhill, run the machine at a slow speed as much as possible to prevent an overrun.
- During operation, check the tachometer on the monitor display screen from time to time to identify any increases or decreases in engine speed.

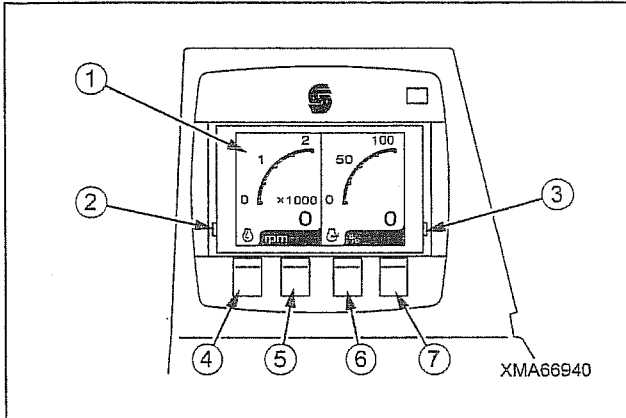

- (1) Display
- (2) Left side warning lamp (Red)
- (3) Right side warning lamp (Red)
- (4) Button
- (5) Button
- (6) Button
- (7) Button

The monitor display consists of a screen, one right and one left side warning lamp, and four buttons.

The following shows the screens during normal operation.

[Screen display 1]

The left plane of the screen displays the engine speed (rpm) and the right plane displays the engine torque (%).

★Turning the starting switch to "ON" displays this screen.

[Screen display 2]

The upper left side of the screen displays the HST hydraulic oil temperature (Celsius), the lower left side displays the HST hydraulic oil pressure (bar), the upper right side displays the fuel level (%), and the lower right side displays the clock/date (Time).

• Display of HST hydraulic oil temperature

If the temperature drops to "20 deg C" or below, right and left side warning lamps (2) and (3) flash.

Continue the warming up operation until the lamps turn off.

If the temperature increases to "100 deg C" or above, right and left side warning lamps (2) and (3) start to flash and the alarm buzzer sounds.

If warning lamps (2) and (3) start to flash and the alarm buzzer sounds, reduce the engine speed to mitigate the load on the hydraulic equipment.

• Display of HST hydraulic oil pressure

If the pressure goes to "9.5 bars" or below, right and left side warning lamps (2) and (3) start to flash and the alarm buzzer sounds. If warning lamps (2) and (3) start to flash and the alarm buzzer sounds, stop the operation immediately and check for clogging in the hydraulic oil line filter and the strainer in the hydraulic tank, the hydraulic piping for oil leakage, and the oil level inside the hydraulic tank. If the inspection does not detect any abnormalities, please contact your distributor for checkups..

★For the procedure of switching from "Screen display 1" to "Screen display 2", see "[1]Switching of screen display during normal operation".

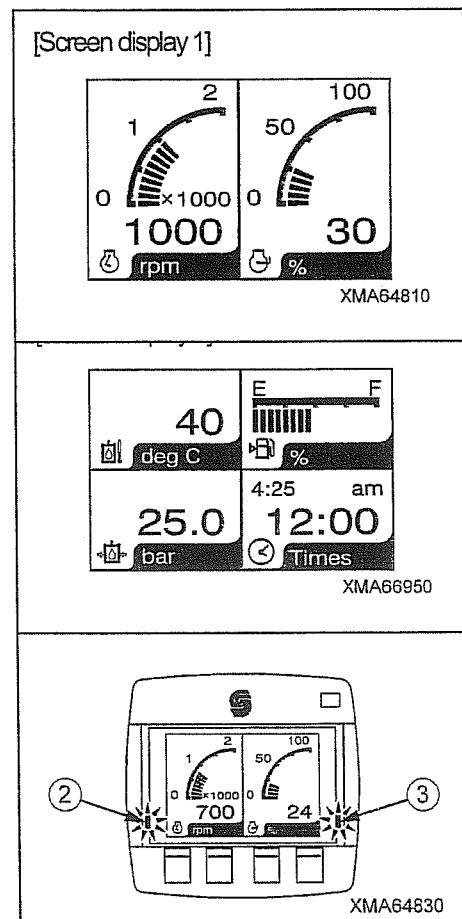

[1] SWITCHING OF SCREEN DURING NORMAL OPERATION

Follow the procedure given below when switching the screen display.

1. Turn the starting switch to "ON" to bring up "Screen display 1" in Screen (1) as shown in the figure at right.
2. From the normal state of "Screen display 1", press any of the four buttons (4) to (7). The softkeys as shown in the figure below appear at the bottom of Screen (1).



★ These softkeys disappear unless they are operated within three seconds.

: Switches the display to the Screen Brightness/Contrast Adjustment screen.

: Switches the display to the previous page.

: Switches the display to the next page.

: Moves the display to the main menu.

3. When the softkeys appeared, press a desired softkey or (5) or (6) of the buttons shown below within three seconds. Screen (1) is switched to "Screen display 2".

★ To switch from "Screen display 2" to "Screen display 1", carry out the operation in a similar way to itching from "Screen display 2" to "Screen display 1", do carry out the operation in a similar way to that described in items 2 and 3 above.

★ Turn the starting switch to "OFF" once and then turn it "ON" again. "Screen display 1" will appear.

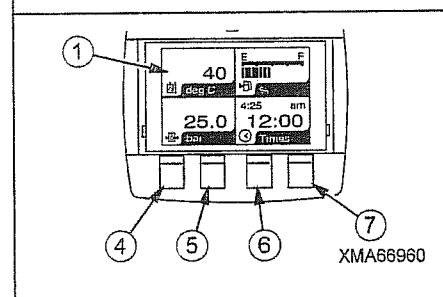
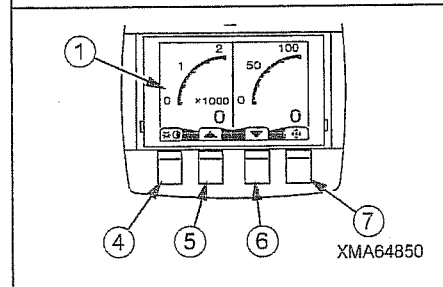
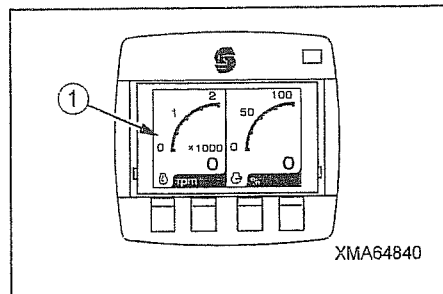

[2] ADJUSTING SCREEN BRIGHTNESS AND CONTRAST

Adjust the screen brightness and contrast in following the procedure.

1. Turn the starting switch to "ON" to bring up "Screen display 1" as shown in the figure at right.
2. From the normal state of "Screen display 1", press any of the four buttons (4) to (7). The softkeys as shown in the figure below appear at the bottom of Screen (1).

★ These softkeys disappear unless they are operated within three seconds.



3. Press button (4) below within three seconds from when the softkeys appear. "Screen Brightness/Contrast Adjustment screen" appears in Screen (1).
4. Press buttons (4) to (7) that appear below the softkeys (+) and (-) at the bottom of Screen (1) to adjust the brightness (left plane of screen) and contrast (right plane of screen) of the desired backlights.

★ If these softkeys are not operated for three seconds, the screen will return to "Screen display 1".

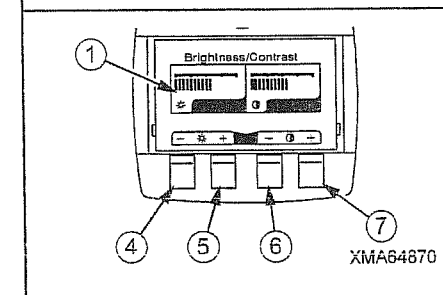
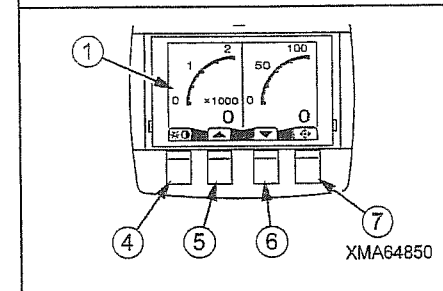
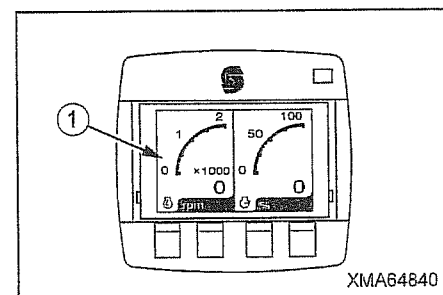

2.3 SWITCHES AND LEVERS ON CONTROL PANEL BOX

[1] STARTING SWITCH

This switch is used to start and stop the engine.

- OFF: The starting key can be inserted and removed at this position. When the key is turned to this position, all the switches for the electric circuits are turned off, and the engine stops.

- ON, PREHEAT: Electricity flows to the charging circuit and lamp circuit.

When starting the engine in low temperatures, set the key to this position. The engine intake air is heated to make it easier to start the engine.

If the key is set to this position, "Preheat indicator lamp" on the control panel box will light up. The lamp turns off when preheating is completed. Turn the starting key quickly to the START position to start the engine.

- START: This is the position for starting the engine (the starting motor turns).

When the engine starts, release the key.

The key will return automatically to the ON position.

★After the engine is started, do not turn the key to the OFF position except when stopping the engine.

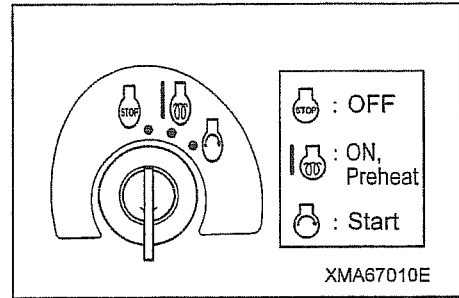

[2] ENGINE SPEED CONTROL DIAL

NOTICE

- If the engine is stopped before it has cooled down properly, there is danger that the service life of the engine parts will be reduced.
Never stop the engine suddenly except in cases of emergency.
- If the engine has overheated, do not suddenly stop it. Run the engine at a midrange speed and gradually cool it down before stopping it.
- If you press the knob of the engine speed control dial, the engine speed will drop suddenly to low idling.
Use this method to reduce the engine speed only when an abnormality has occurred in the engine or when there is an emergency. Do not use it for normal operations.

This dial is used to control the engine speed and output.

- Turn dial knob to left (Counterclockwise): Engine runs at high speed

- Turn dial knob to right (Clockwise): Engine runs at low speed

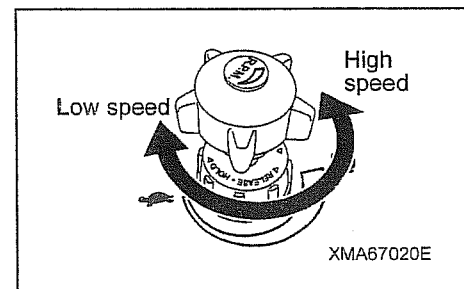

- Press dial knob: Engine speed goes down to low idling speed.

★ Do not use it for normal operations.

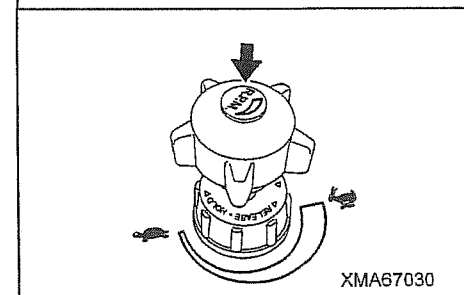

[3] HI-LO SPEED RANGE SELECTOR SWITCH

⚠ WARNING

- When traveling on slopes, always set the travel speed range to low speed. If the machine is driven in the high speed range, it will cause the engine to overrun.
- When traveling with a load, always set the travel speed range to low speed. If the machine is driven in the high speed range, it will cause the engine to overheat.

This switch is used to select the travel speed range.

When the switch is operated, the speed selection mechanism inside the travel motor is actuated and the machine enters the high speed range or low speed range.

In the high speed range and low speed range, if the engine speed and the amount the travel lever is operated are the same, the travel speed changes.

- H: The travel motor changes to the high speed range and the high speed lamp on the control panel lights up.
- L: The travel motor changes to the low speed range and the high speed lamp on the control panel goes out.

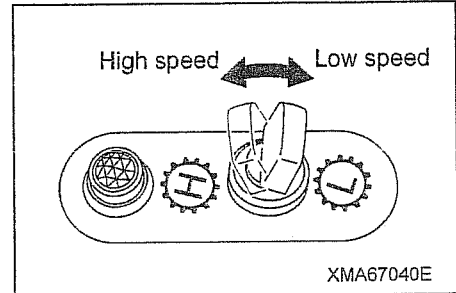

[4] PARKING BRAKE SWITCH

NOTICE

Whenever starting the engine, turn the starting switch to "ON" and then press the parking brake to the "Parking" position (the built-in lamp will light up).

This switch is used to operate the parking brake inside the travel motor.

- Push: The parking brake is applied, the parking brake lamp lights up, and the alarm buzzer sounds.
- Push again: The travel motor changes to the low speed range and the high speed
- ON (STOP): The parking brake is applied, the parking brake lamp lights up, and the alarm buzzer sounds.
- OFF (RUN): The parking brake is released and the parking brake lamp goes out.

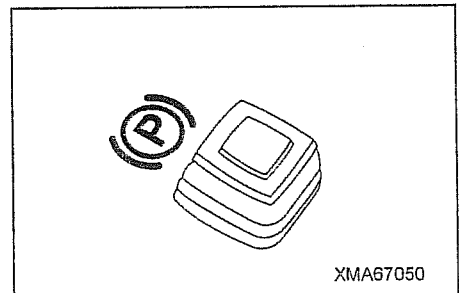

[5] COMBINATION SWITCH

This switch is used to operate the horn, head lamps, lighting, and turn signal lamps.

- Press center of switch: Horn sounds.
- Turn switch knob (1) one stage clockwise: Head lamp (Lo) and instrument lighting light up.
- Turn switch knob (1) two stages clockwise: Head lamp (Hi) and instrument lighting light up. If the switch knob (1) is set to this position, "Head lamp high beam lamp" on the control panel box will light up.
- Move lever (2) to left: Left turn signal lamp and instrument lighting flashes.
- Move lever (2) to right: Right turn signal lamp and instrument lighting flashes.

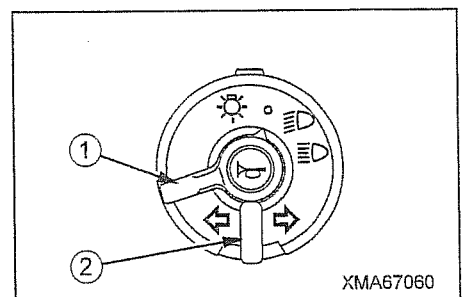

2.4 SWITCHES ON CAB CEILING

[1] WIPER, WASHER SWITCH

This switch is used to operate the wiper and window washer.

- ON (Wiper mark): Wiper moves continuously.
Press the switch further, the window washer fluid is sprayed out while the switch is being pressed fully.
- OFF: Wiper stops and automatically returns to the storage position.

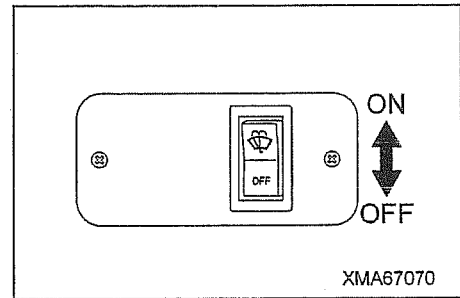

[2] ROOM LAMP (WITH SWITCH)

This room lamp is installed to left side of the cab top.

Operate the room lamp switch as follows.

- ON: Room lamp lights up.
- OFF: Room lamp goes out.

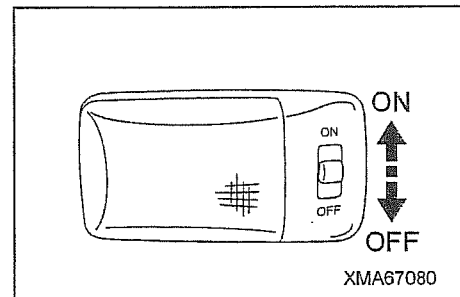

2.5 WARNING DEVICES

[1] HORN

Horn (1) is installed inside the front grill to the frame on the left side of the radiator.

When the starting switch is turned ON and the horn switch is pressed, horn (1) will sound continuously.

Always sound the horn to warn the people in the surrounding area before starting the engine or before moving the machine off.

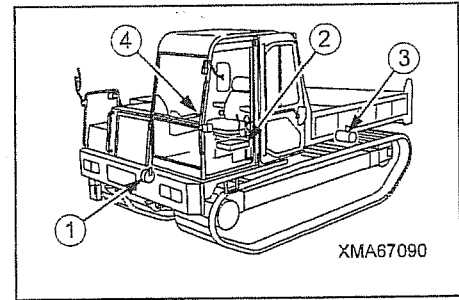

[2] SLOPE ALARM BUZZER

Slope alarm buzzer (2) is installed under the operator's seat.

If the angle of the slope goes above the set angle when the machine is traveling, slope alarm buzzer (2) will automatically sound intermittently to warn the operator that the angle is too large.

It is dangerous to continue traveling with the dump body loaded when slope alarm buzzer (2) sounds.

When traveling downhill, do as follows to prevent any danger from overrunning.

1. Operate the throttle lever to set the **engine speed to low speed**.
2. Set the travel lever as **close as possible to the N position**, then drive the machine carefully.
3. If the load in the dump body exceeds the maximum payload or is near the maximum payload, reduce the load.

[3] BACKUP BUZZER

Backup buzzer (3) is installed on the left side inside the frame at the rear of the chassis.

When the engine is started and the travel lever is operated to REVERSE, backup buzzer e will sound intermittently to warn the operator that the travel lever is at the REVERSE position.

[4] PARKING BRAKE BUZZER

Parking brake buzzer (4) is installed inside the rear box in the operator's compartment.

When the starting switch is turned to ON position and the parking brake switch is pressed, parking brake buzzer (4) will sound intermittently to inform the operator that the parking brake is applied.

2.6 TRAVEL LEVER

⚠ WARNING

- Always stop the machine before switching the travel levers between FORWARD and REVERSE. If the direction of travel is suddenly changed, it may cause damage to the machine.
- Do not operate the travel levers by a large amount suddenly. Always operate them slowly. If they are suddenly operated, the machine and the operator will suffer a large shock.
- When stopping the machine, do not return the travel lever past the N (neutral) position. If the lever is moved past the N (neutral) position, it will cause failure such as reverse rotation of the engine.
- Do not make unnecessary counter rotation turns or sudden turns at high speed. There is danger that the crawlers and hydraulic equipment may be damaged, or that the machine may hit some other object.

The travel levers are used to drive the machine in forward or reverse, to stop or steer the machine, and to control the travel speed.

★ The travel levers become heavier as they are operated in the direction of FORWARD or REVERSE, and become lighter as they are operated back towards N (neutral).

[1] TRAVELING STRAIGHT OR STOPPING

Operate the left and right travel levers at the same time.

- FORWARD: Push the levers forward.
- REVERSE: Pull the levers back.
- STOP: Return the levers to the N position.

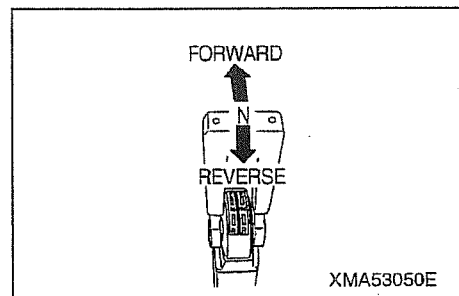

[2] TURNING (STEERING)

Operate the left and right travel levers at the same time, but operate one lever more than the other.

- Traveling forward and turning left: Push the right travel lever forward and return the left travel lever in the direction of N.
- Traveling forward and turning right: Push the left travel lever forward and return the right travel lever in the direction of N.
- Traveling in reverse and turning left: Pull the right travel lever back and return the left travel lever in the direction of N.
- Traveling in reverse and turning right: Pull the left travel lever back and return the right travel lever in the direction of N.

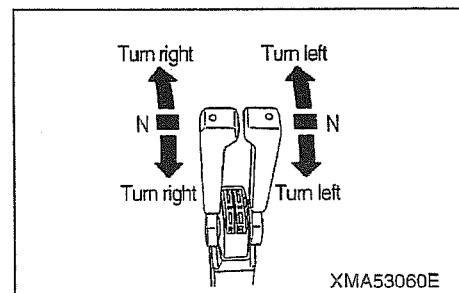

[3] TURNING GRADUALLY

Operate the left and right travel levers by a different amount.

If there is a big difference between the two levers, the machine will turn rapidly.

If there is a small difference between the two levers, the machine will turn gradually.

[4] PIVOT TURN

There are the following two types of pivot turn.

- **Pivot turn:**

Return one travel lever fully to the N position and operate the other travel lever in the direction of FORWARD or REVERSE.

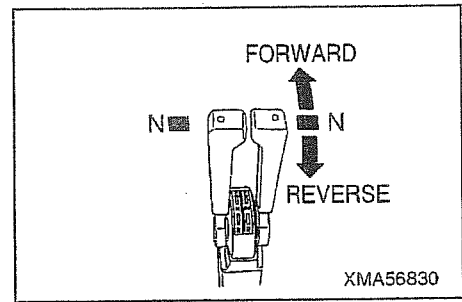

- **Spin turn (counter rotation turn):**

Operate the left and right travel levers in opposite directions.

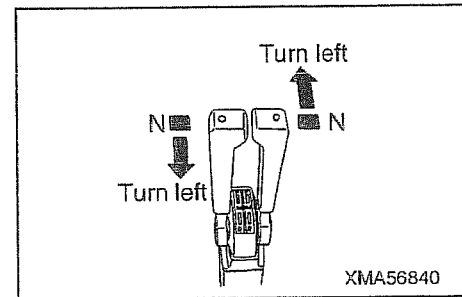

[5] CHANGING TRAVEL SPEED

Change the angle of the travel lever to change the speed.

Operate the travel lever a small amount to travel at low speed, and operate it a large amount to travel at high speed.

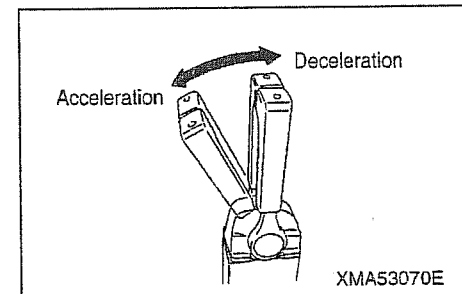

2.7 DUMP CONTROL LEVER

⚠ WARNING

- Always stop the machine before operating the dump body to the dump position.
- Position a signalman to ensure safety in the surrounding area, and follow his signals when carrying out the dumping operation.
- Always operate the dump control lever slowly. If the dump body is suddenly stopped or it is allowed to hit the frame when it is lowered, it will cause failures and will also cause problems of safety in the surrounding area.
- When leaving the operator's compartment with the dump body raised, always lock the dump control lever. In addition, use the safety bar to prevent the dump body from coming down. Even when the engine is stopped, it is possible to lower the dump body.

[1] DUMP CONTROL LEVER

Dump control lever (1) is used to raise and lower the dump body.

There are three operating positions: RAISE, HOLD, and LOWER.

- RAISE: The dump body is raised.
 - HOLD: The dump body is stopped and held in position.
 - LOWER: The dump body is lowered.
- ★When the control lever is released, it automatically returns to the HOLD position.

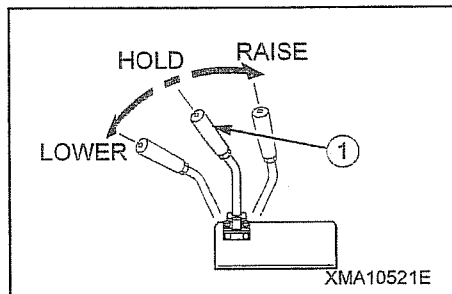

[2] DUMP CONTROL LEVER LOCK

Lever lock (2) is used to hold the dump control lever at the HOLD position.

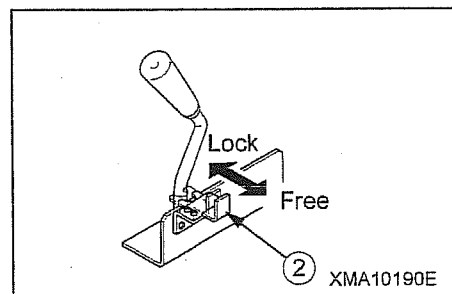

2.8 DUMP BODY SAFETY BAR

⚠ WARNING

- If it is necessary to go under the dump body to carry out inspection and maintenance, always use the safety bar to prevent the dump body from coming down.
- When using the safety bar, check that the bar is fitted securely to the dump body holder.
- The safety bar is a safety device used during inspection and maintenance. Do not use the safety bar to support the dump body when replacing the dump cylinder, valve, hydraulic hoses, or other equipment. In such cases always support the dump body with a crane.

Safety bar (1) is a device to ensure safety during operations, and is used when going under the dump body to carry out inspection and maintenance.

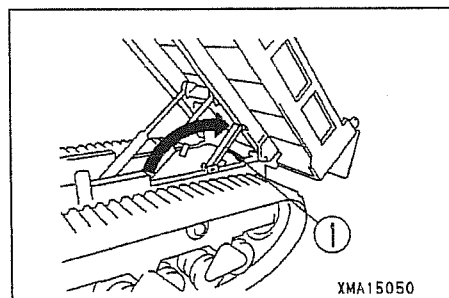

2.9 AIR CONDITIONER

NOTICE

- When using the air conditioner, do not suddenly raise the engine speed to high speed. This will cause failure.
- Do not bring any flame close the controls.
- When cleaning the air conditioner filters, carry out the operation carefully. If the filter is clogged, the efficiency of the air conditioner will be reduced, and it will also lead to failure.

2.9.1 LOCATION OF VENTS

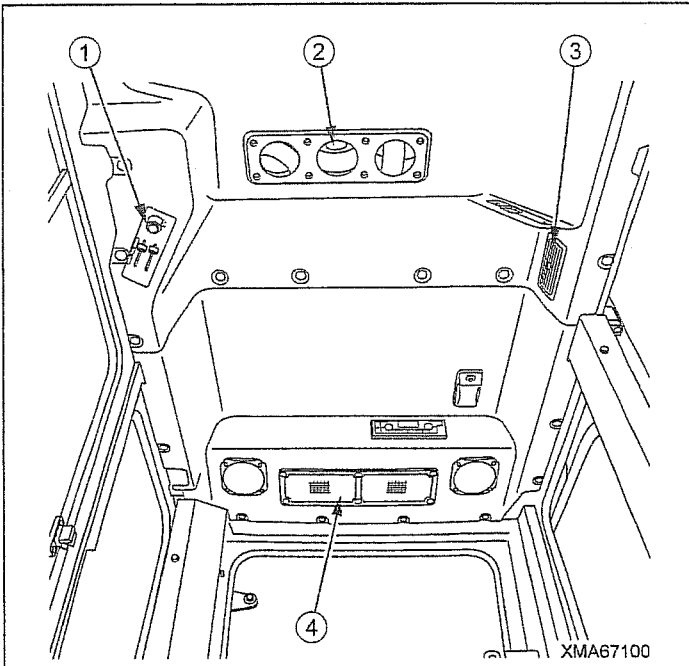

- (1) Controller
- (2) Cab ceiling vent
- (3) Cab ceiling side vent
- (4) Air inlet filter

★The direction from 2 vents can be changed by changing the direction of the louvers.

In addition, the louvers can be opened or closed manually.

2.9.2 CONTROLLER

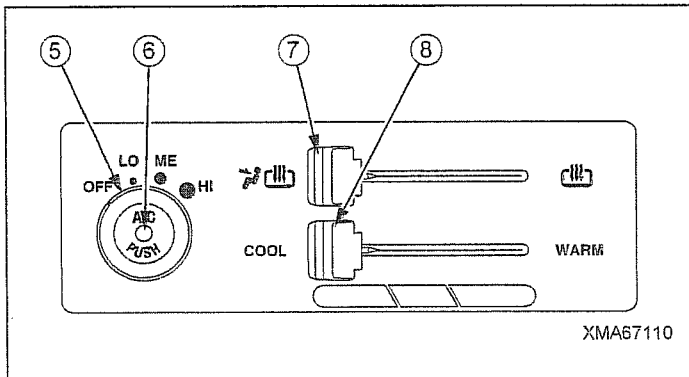

- (5) Fan switch
- (6) Air conditioner switch
- (7) Mode switch
- (8) Temperature control switch

[1] FAN SWITCH (5)

This is used to control the flow of air from the vents. The air flow can be controlled to three levels.

- Turn the switch to OFF: The air flow is stopped.
- Turn the switch to LO: The air flow is the lowest.
- Turn the switch to ME: The air flow is medium.
- Turn the switch to HI: The air flow is the highest.

If fan switch (5) is turned, the fan can be operated simply as a fan regardless of the operation of air conditioner switch (6).

[2] AIR CONDITIONER SWITCH (6)



This switch is used to operate the air conditioner.

After turning fan switch (5), press air conditioner switch (6). The air conditioner will start working.

Press the air conditioner switch (6) again. The air conditioner will stop working.

[3] MODE SWITCH (7)

Use this switch when selecting the vents.

- Move the lever to : Air blows out from the 2 vents at cab ceiling.
- Move the lever to : Air blows out from the 2 vents at cab ceiling.
- ★ Air will blow out from the 2 vents at cab ceiling when any section of mode switch lever is moved.

[4] TEMPERATURE CONTROL SWITCH (8)

This is used to control the temperature of the air blowing out from the vent.

- Move the lever to COOL end: The air temperature becomes lower.
- Move the lever to WARM end: The air temperature becomes higher.

2.9.3 OPERATION OF AIR CONDITIONER

[1] HEATING OPERATION

1. Move the mode switch (7) to the left end position.

★ Hot air will blow out when any section of mode switch (7) is moved, but this mode is generally used.

2. Move the temperature control switch (8) to WARM end and set the temperature of the air coming from the vents to the highest position.

3. Turn the desired position of fan switch (5). Hot air will blow out from the cab ceiling vents.

The above operation sets the air conditioner to [heating].

If air conditioner switch (6) is pressed ON, the mode will be set to [dehumidifying + heating].

★ Use temperature control switch (8) and fan switch (5) to control the temperature inside the cab.

[2] COOLING OPERATION

1. Move the mode switch (7) to the left end position.

★ Hot air will blow out when any section of mode switch (7) is moved, but this mode is generally used.

2. Move the temperature control switch (8) to WARM end and set the temperature of the air coming from the vents to the lowest position.

3. Turn the desired position of fan switch (5).

4. Press the air conditioner switch (6). Lamp (Blue) lights up, and cool air will blow out from the cab ceiling vents.

★ If Lamp (Blue) does not light up when pressing the air conditioner switch (6), Check the refrigerant (Gas) volume or

The above operation sets the air conditioner to [cooling].

★ Use temperature control switch (8) and fan switch (5) to control the temperature inside the cab.

2.9.4 EFFICIENT USE OF AIR CONDITIONER

[1] CARRYING OUT QUICK COOLING

If the machine is left outside on a hot, sunny day, the temperature inside the cab may go above 80 deg C.

In such a case, do as follows.

1. Open the cab windows to let the hot air inside the cab escape.
2. After starting the engine, press the mode switch to the left end position.
3. Move the temperature control switch (8) to COOL end and set the temperature of the air coming from the vents to the lowest position.
4. Turn the fan switch (5) to "LO" position.
5. Press the air conditioner switch (6). Cool air will blow out from the cab ceiling vents.
6. Raise the engine speed to a slightly higher speed (1000 rpm or above) and run the engine for 2 - 3 minutes.
7. Turn the fan switch (5) to "HI" position to set the air flow to higher.
8. Close the cab windows.

[2] WHEN WINDOWS ARE MISTED UP

In the rainy season or on humid days, if the humidity inside the cab is high and the windows mist up, it is possible to operate the air conditioner to clear the mist on the inside of the windows. On the other hand, if the outside humidity is high, the outside of the windows may mist up if the air conditioner cooling is too strong.

If this happens, stop the air conditioner and adjust the temperature inside the cab.

[3] ACTION WHEN NOT USING AIR CONDITIONER

If the air conditioner is not to be used for a long time, operate the air conditioner for several minutes once a month to prevent loss of the oil film on the moving parts of the compressor.

When doing this, run the engine at low speed.

[4] WHEN COOLING CANNOT BE USED IN COLD TEMPERATURES

It may not be possible to operate the cooling if the temperature inside the cab is low (below 15 deg C).

In such a case, use the heater to raise the temperature inside the cab.

2.10 RADIO

NOTICE

The radio can be used when the starting switch is at the ON position.

If the radio is operated with the engine stopped, the battery will be discharged and it may be impossible to start the engine.

Always run the engine when using the radio.

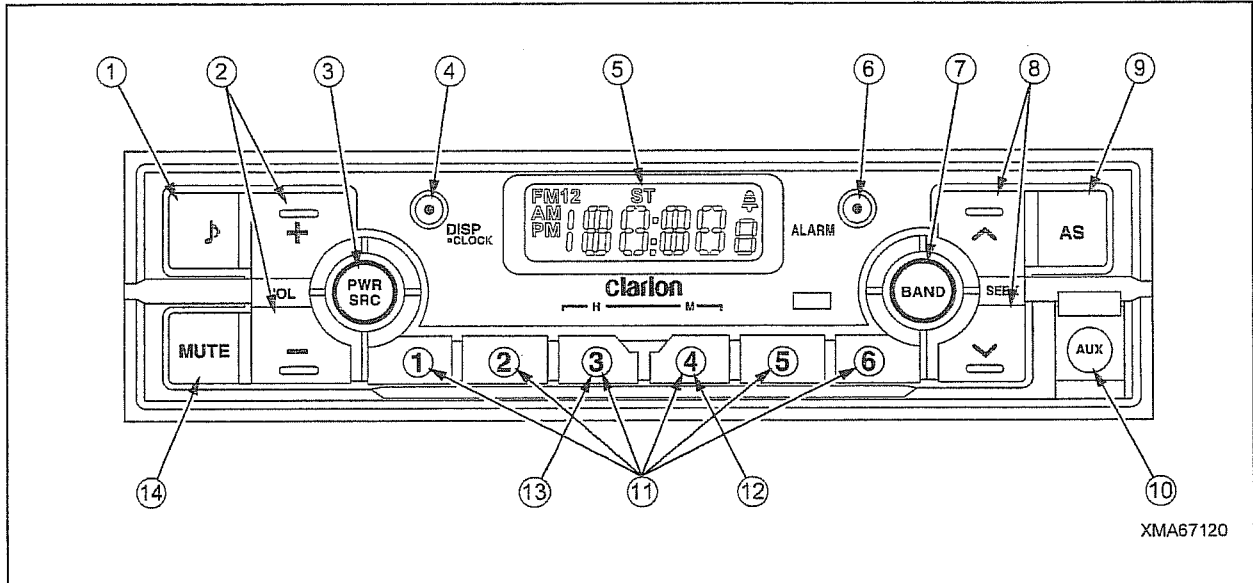

(1) [🎵] button

- Press to switch to the audio mode.

(2) [+/-] button

- Press to adjust the volume.

(3) [PWR/SRC] button

- Turn the power ON/OFF.
- Switch to the operation mode.

(4) [DISP/CLOCK] button

- Press to switch the display.
- Press and hold (2 sec.) to switch to the clock setting mode.

(5) Display

(6) [ALARM] button

- Press to turn alarm ON/OFF.
- Press and hold (2 sec.) to switch to the alarm setting mode.

(7) [BAND] button

- Change bands while in radio mode.

(8) [^] [v] buttons

- Press to seek a station manually.
- Press and hold (1 sec.) to seek a station automatically.

(9) [AS] button

- Press to perform auto store.

(10) [AUX] input jack

- Input jack for connecting external device.

(11) [1] [2] [3] [4] [5] [6] direct buttons

- Store radio stations in memory or recall it directly while in radio mode.

(12) [M] button

- Press to set minute while setting clock or alarm.

(13) [H] button

- Press to set hour while setting clock or alarm.

(14) [MUTE] button

- Turn mute function ON and OFF.

2.10.1 BASIC OPERATIONS

CAUTION

Be sure to lower the volume before switching OFF the unit power or car's ignition key.
The unit remembers its last volume setting.

[1] TURNING POWER ON/OFF

1. Press the [PWR/SRC] button (3) to turn ON power.
2. Press and hold (2 sec.) the [PWR/SRC] button (3) to turn OFF power.

[2] SELECTING MODS

1. Press the [PWR/SRC] button (3) to change operation mode.
2. Each time the [PWR/SRC] button (3) is pressed, the operation mode changes as follows:

Radio ⇒ AU1 (AUX1) ⇒ AU2 (AUX2) ⇒ Radio.....

★ If no operation is performed for 5 seconds or more, the unit will return to the clock display.

[3] ADJUSTING THE VOLUME

Press the [+] button (2) to increase volume; Press the [-] button (2) to decrease volume.

★ Volume range is 0 (minimum) to 31 (maximum).

[4] MUTE

1. Press the [MUTE] button (14). The sound turns OFF and "MUTE" appears in the display.
2. Press the [MUTE] button (14) again to cancel the mute mode.

[5] SWITCHING THE DISPLAY

Press the [DISP/CLOCK] button (4) to select the desired display.

[6] SETTING THE CLOCK

1. Press and hold the [DISP/CLOCK] button (4). The clock blinks in the display.
2. Press the [H] button (13) or [M] button (12) to set the hour or minute.
3. Press the [^] or [v] button (8) to set the time.

★ The clock is displayed in 12-hour format.

4. Press the [DISP/CLOCK] button (4) to finish the setting.

[7] SETTING THE ALARM

1. Press and hold the [ALARM] button (6). There will be a short beep, the "🔔" and the clock blinks in the display.
2. Press the [H] button (13) or [M] button (12) to set the hour or minute.
3. Press the [^] or [v] button (8) to set the alarm time.
4. Press the [ALARM] button (6) to finish the setting.

◦ Stop the alarm

There will be a beep for 3 minutes during alarm, you can press the [ALARM] button (6) to stop the alarm.

◦ Turn ON/OFF the alarm

Press the [ALARM] button (6) to turn ON or OFF the alarm, and the "🔔" is lit ON or OFF.

[8] AUDIO ADJUSTMENT

Sound effects and tone can be adjusted as desired.

• Adjusting the bass

1. Press the [♪] button (1) to select "BA".
2. Press the [+] or [-] button (2) to adjust the gain.

★ The factory default setting is "0". (Adjustment range: +5 to -5)

• Adjusting the treble

1. Press the [♪] button (1) to select "TR".
2. Press the [+] or [-] button (2) to adjust the gain.

★ The factory default setting is "0". (Adjustment range: +5 to -5)

• Adjusting the balance

1. Press the [♪] button (1) to select "BL".
2. Press the [+] or [-] button (2) to adjust balance between right and left speakers.

★ The factory default setting is "0". (Adjustment range: R5 to L5)

★ When in the audio adjustment mode, if no operation is performed for 7 seconds or more, the mode is cancelled and the unit returns to the previous mode.

2.10.2 RADIO OPERATIONS

[1] CHANGING THE RECEPTION AREA

This unit is initially set to Europe frequency intervals of 9 kHz for AM and 50 kHz for FM;

When using it outside the Europe, the frequency reception range should be switched to the intervals below.

		U.S. standard	Other countries	Europe standard
AM	Frequency spacing	10 kHz	9 kHz	9 kHz
	Frequency range	530 to 1,710 kHz	531 to 1,629 kHz	531 to 1,602 kHz
FM	Frequency spacing	AUTO: 200 kHz Manual: 100 kHz	50 kHz	50 kHz
	Frequency range	87.9 to 107.9 MHz	87.5 to 108.0 MHz	87.5 to 108.0 MHz

[2] SETTING THE RECEPTION AREA

★ All station preset memories are lost when the reception area is changed.

1. Press the [BAND] button (7) and select the desired radio band (FM or AM).

U.S. standard (new setting)

2. While pressing the [♪] button (1), press and hold the number [1] button (11) for 2 seconds or longer.

Other countries (new setting)

3. While pressing the [♪] button (1), press and hold the number [2] button (11) for 2 seconds or longer.

Europe standard (initial setting)

4. While pressing the [♪] button (1), press and hold the number [3] button (11) for 2 seconds or longer.

[3] LISTENING TO BROADCASTS

1. Press the [PWR/SRC] button (3) and select radio mode.
2. Press the [BAND] button (7) and select the reception band. Each time the button (7) is pressed, the band changes as follows:

FM1 ⇒ FM2 ⇒ AM1 ⇒ AM2 ⇒ FM1....

[4] TUNING

3 tuning modes are available: seek tuning, manual tuning and preset tuning.

[5] SEEK TUNING

Press and hold (1 sec.) the [^] or [v] button (8) to automatically seek stations.

When the [^] button (8) is pressed, the station is sought in the direction of higher frequencies; if the [v] button (8) is pressed, the station is sought in the direction of lower frequencies.

[6] MANUAL TUNING

Press the [^] or [v] button (8) to manually tune a station.

[7] RECALLING A PRESET STATION

A total of 24 preset positions (6-FM1, 6-FM2, 6-AM1, 6-AM2) can be used to store broadcast stations in memory. Press the corresponding direct button (12) ([1] to [6]) to automatically recall the stored frequency.

[8] MANUAL MEMORY

1. Use seek tuning or manual tuning to select the desired station.
2. Press and hold (2 sec.) one of the direct buttons (12) to store the current station in preset memory.

[9] AUTO STORE

The auto store function stores up to 6 stations automatically tuned in sequential order. If 6 stations cannot be found, any previously stored station remains in its memory position.

1. Press the [BAND] button (7) and select the desired band (FM/AM).
2. Press the [AS] button (9). The stations with good reception are stored automatically to the preset channels.

2.10.3 AUX FUNCTION

An external input jack (AUX1) on the front panel and a rear AUX terminal (AUX2) are provided to allow playback of sound and music from external devices.

[1] SELECTING AUX MODE

1. Press the [PWR/SRC] button (3) to select "AU1" (AUX1) or "AU2" (AUX2).

WARNING

If the front panel's external input jack AUX cover is fastened insecurely, water could enter the unit, causing malfunction or fire.

Always be sure the AUX cover is fastened securely when the jack is not in use. Also, whenever a plug is inserted into the jack, avoid exposing the connector to water or other liquid.

2.11 FUSE BOX ON CONTROL PANEL BOX

⚠ CAUTION

- Always turn the starting switch to the OFF position before replacing the fuse.
- If the fuse is blown, always check for the cause in that circuit and carry out repairs before replacing the fuse.
- When replacing the fuse, always replace it with a fuse of the same capacity.

NOTICE

Fuses are devices to prevent electrical equipment and wiring from burning out. If a fuse is corroded or covered in white powder, always replace it.

1. Remove fuse box cover (1), and check or replace the mini-fuses inside it.

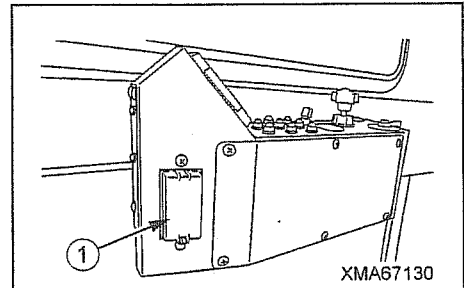

2. The fuses inside the fuse box are for the circuits shown in the table below.

No.	Capacity	Name of circuit
1	15A	Room lamp
2	15A	Radio, Air conditioner
3	10A	Wiper, Washer
4	10A	Parking brake switch
5	10A	Crane (Option)
6	15A	Head lamp, Horn, Turn signal
7	10A	Hour meter, H-L speed range switch, Slope sensor
8	5A	Indicator lamp
9	5A	Buzzer, Display
10	5A	Glow
11	5A	Ignition
12	5A	Spare
13	10A	Spare
14	15A	Spare

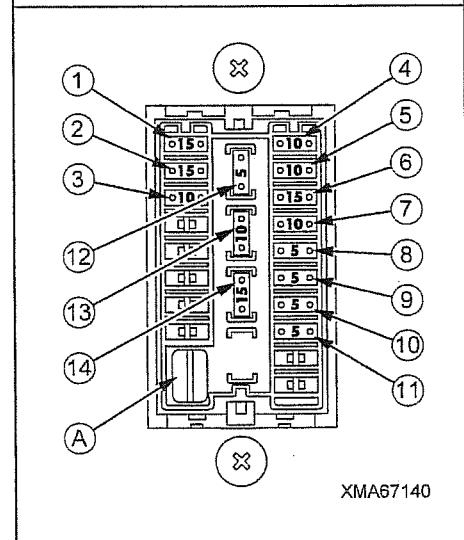

★(A) in the figure indicates the clip used for replacing a fuse. Use this clip when replacing a fuse.

2.12 FUSE BOX IN CAB AT REAR RIGHT PORTION

⚠ CAUTION

- Always turn the starting switch to the OFF position before replacing the fuse.
- If the fuse is blown, always check for the cause in that circuit and carry out repairs before replacing the fuse.
- When replacing the fuse, always replace it with a fuse of the same capacity.

NOTICE

Fuses are devices to prevent electrical equipment and wiring from burning out.
If a fuse is corroded or covered in white powder, always replace it.

1. Remove fuse box cover (1), and check or replace the mini-fuses inside it.

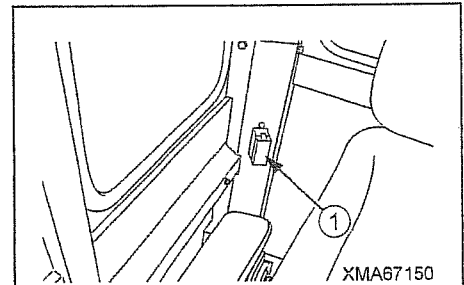

2. The fuses inside the fuse box are for the circuits shown in the table below.

No.	Capacity	Name of circuit
1	10A	Room lamp
2	10A	Radio (Main power)
3	10A	Radio (ACC)
4	15A	Air conditioner fan
5	10A	Air conditioner compressor
6	10A	Spare
7	15A	Spare

- ★(A) in the figure indicates the clip used for replacing a fuse. Use this clip when replacing a fuse.

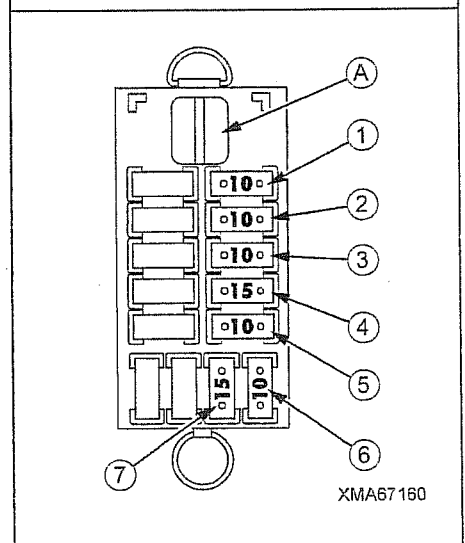

2.13 FUSES INSIDE WIRING HARNESS AT BATTERY

⚠ CAUTION

- Always turn the starting switch to the OFF position before replacing the fuse.
- If the fuse has melted, always check the circuit to find the cause, and carry out repairs before replacing the fuse.
- When replacing the fuse, always replace it with a fuse of the same capacity.

[1] MOUNTING POSITION AND TROUBLESHOOTING OF FUSE, CIRCUIT BREAKER AND DIODE

• Mini-fuse (1) (20A)

This is the mini-fuse provided between the battery and "DC-DC converter" (input 24 V, output 12 V) for supplying power to the air conditioner and other parts.

Check it and, if necessary, replace it if the air conditioner does not work due to the incapacitated compressor or the fan motor of the air conditioner.

• Slow blow fuse (2) (65A)

If the battery charge lamp stays lighted up during operations, carry out inspection and replacement.

• Slow blow fuse (3) (75A)

If the power does not come on when the starting switch is turned to the ON position, carry out inspection and replacement.

• Circuit breaker (4) (80A)

This is the circuit breaker provided to protect the battery from overcharging due to reasons such as excessive engine speed.

If an overcharge is detected, check whether the blue button of the circuit breaker is pushed out. If it is, push it back to its original position using your hand.

• Diode (5) (Blue)

It is the diode used for the backflow-preventing starter relay.

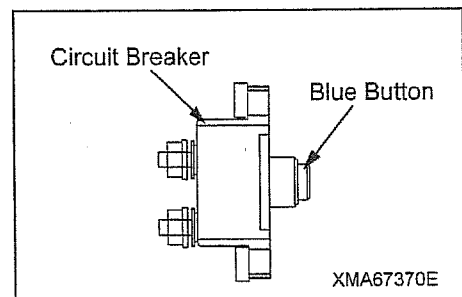
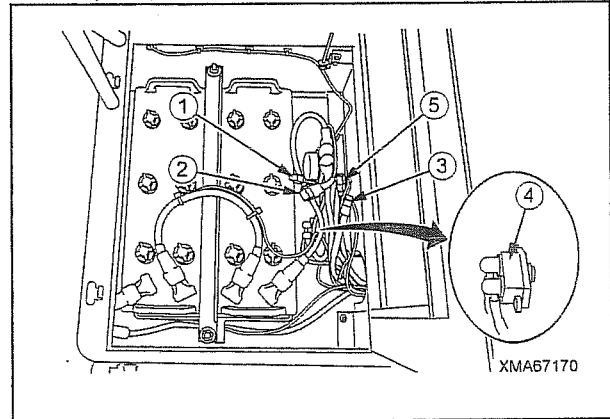

[2] METHOD OF REPLACEMENT

Replace these mini-fuses and slow blow fuses as follows.

1. Open the battery inspection cover. For details, see 2.19 BATTERY INSPECTION COVER in the operation section.
2. Open the rubber cover inside the battery box and check each fuse or fusible link in the wiring harness.
 - For mini-fuse (1), open the cover, take out the fuse, then carry out inspection and replacement.
 - For slow blow fuses (2) and (3), disconnect the fuse case connector, take out the fuse, and carry out inspection and replacement.

2.14 OPERATOR'S SEAT

⚠ CAUTION

- Adjust the operator's seat before operations. Always adjust the operator's seat after it has been used by another operator.
- Adjust the operator's seat so that you can operate the travel lever easily with your back against the seat backrest.
- Never adjust the seat when traveling.

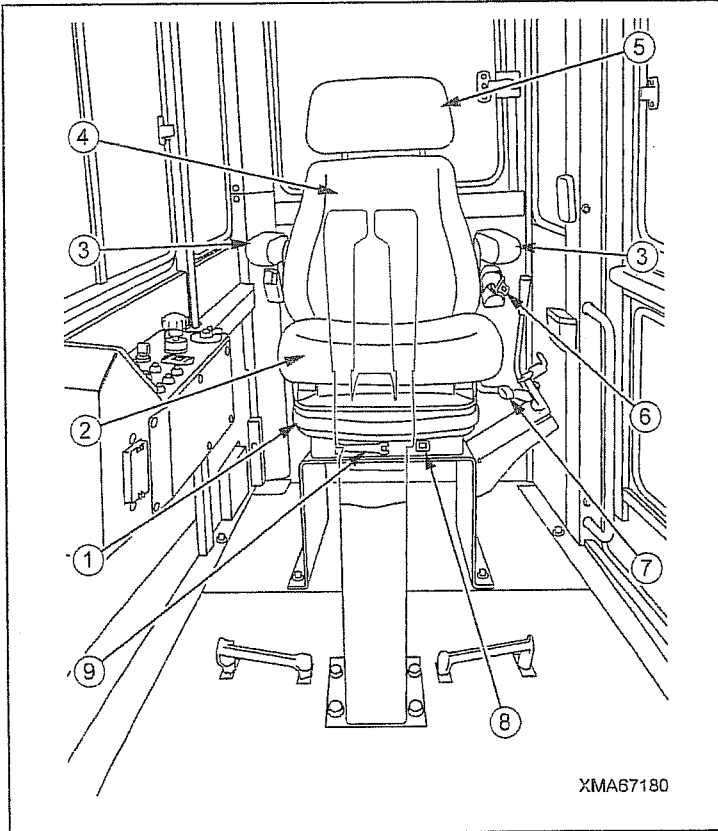

- (1) Suspension
- (2) Seat
- (3) Arm rest
- (4) Back seat
- (5) Head rest
- (6) Reclining adjustment lever
- (7) Front-rear slide lever
- (8) Suspension indicator
- (9) Suspension adjustment lever

[1] ADJUSTMENT OF SEAT FRONT - REAR SLIDE

Use seat front-rear slide lever (7) to adjust.

Keep lever (7) pulled up and move the seat (2) to the front or rear.

After adjusting, release lever (7) and lock it in position.

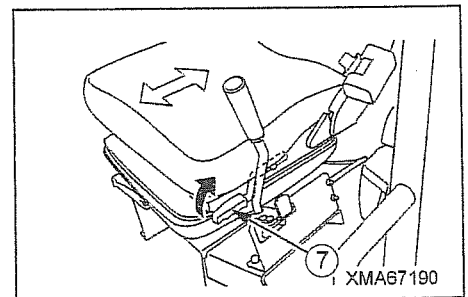

[2] ADJUSTMENT OF RECLINING ANGLE

Use reclining adjustment lever (6) to adjust the reclining angle.

Sit in the seat, keep lever (6) pulled up, and tilt the backrest to the front or rear.

- Front: Move your back away from seatback (4).
- Rear: Push your back against seatback (4).

After adjusting, release lever (6) and lock it in position.

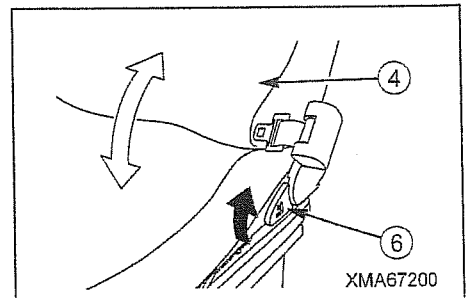

[3] ADJUSTMENT OF SEAT SUSPENSION (hardness)

Using lever (9), adjust the suspension to match your own weight.

Stand up from the operator's seat, turn lever (9) to the right or left, and adjust the display on suspension indicator (8) to match your own weight.

- Turn to right: Suspension indicator (8) shows heavier weight.
- Turn to left: Suspension indicator (8) shows lighter weight.

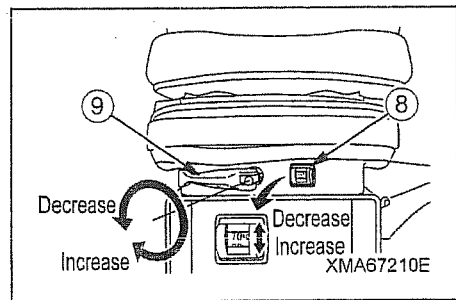

[5] ADJUSTMENT OF HEADREST

Headrest (5) can be adjusted up or down.

Move headrest (5) up or down to adjust.

If the headrest is moved fully up, it can be removed.

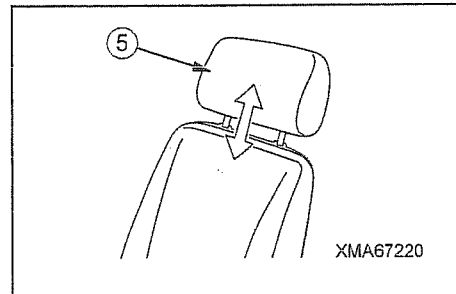

2.15 SEAT BELT

⚠ WARNING

- Before fastening seat belt, always check that there is no abnormality in the belt mount or seat belt clamps. If there is any wear or damage, always replace the seat belt.
- Always adjust the seat belt and fasten it before starting operations.
The seat belt is installed to prevent the danger of the operator falling from the operator's seat if the machine tips at an angle when traveling.
- Do not use the left or right seat belts when they are twisted.

NOTICE

When the seat belt has been used for a long period, and the belt is damaged or starting to become fluffy, or if the clamps are broken or distorted, replace with a new seat belt.
Always replace the seat belt once every three years even if there is no visible sign of abnormality.

[1] REMOVAL AND INSTALLATION OF SEAT BELT

1. Sit in the operator's seat, push your back against the back of the seat, and adjust the operator's seat to a position where it is possible to operate the travel lever easily. For details, see 2.14 OPERATOR'S SEAT in the operation section
2. Hold tongue (2) of seat belt (1) in your hand and pull out seat belt (1) slowly.
3. Fit seat belt (1) as low as possible across your hips and fit it to your body so that there is no slack.
4. Insert tongue (2) into buckle (3) so that seat belt (1) is not twisted.
5. Pull seat belt (1) and check that tongue (2) and buckle (3) are securely locked.
6. When removing seat belt (1), push in tip (4) of buckle (3) and pull out tongue (2).

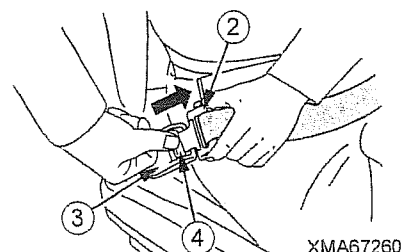
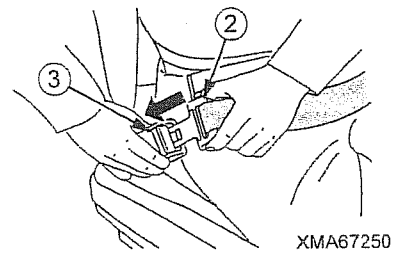
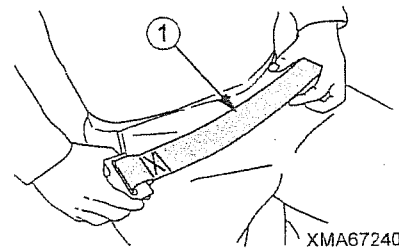
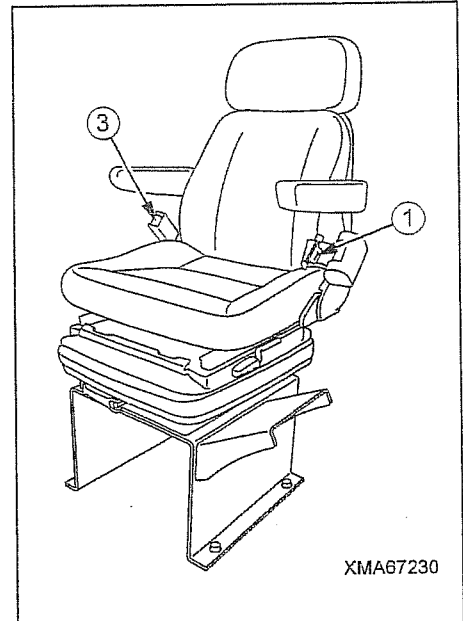

2.16 WINDOW SHIELD

2.16.1 OPENING AND CLOSING CAB DOOR

⚠ CAUTION

When keeping the door open, open the door until it is locked securely in the latch on the cab.

[1] METHOD OF OPENING DOOR WHEN GETTING ON MACHINE

1. Insert the key in door lock (1) and turn to the right to unlock the door.
2. Pull door handle (2) and open the door.
3. Open the door fully and push door hook (3) into latch (4).

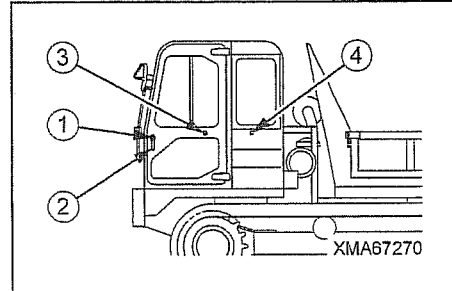

[2] METHOD OF RELEASING DOOR LATCH

⚠ CAUTION

When keeping the door open, open the door until it is locked securely in the latch on the cab.

- Push door latch release lever (5) down.
The door latch is released and it is possible to close the door.

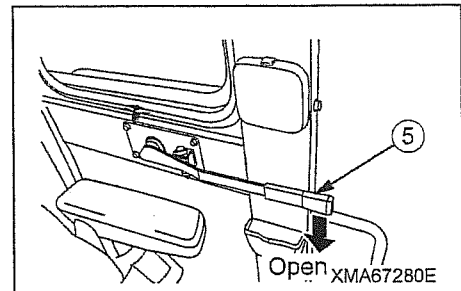

[3] METHOD OF OPENING DOOR WHEN GETTING OFF MACHINE

- Push door handle (6) down.
The door lock is released and it is possible to open the door.

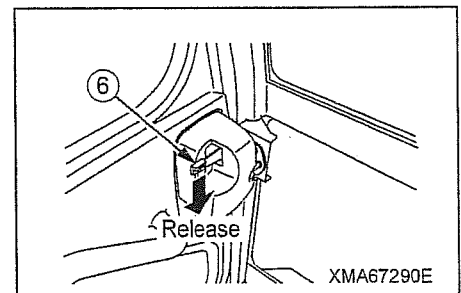

[4] OPENING AND CLOSING LEFT WINDOW INSIDE CAB

⚠ CAUTION

Never put your head or hand outside the window.
If your head or hand are outside the window when loading, there is danger of them being hit by falling materials.

- It is possible to slide the left window to open or close it.
When opening the window, grip lock (1), release the lock, and slide the window open.
When closing the window, keep lock (1) gripped and slide the window to close it.

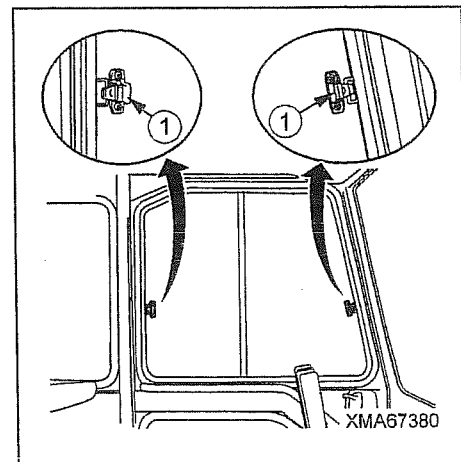

2.16.2 OPENING AND CLOSING RIGHT WINDOW INSIDE CAB

⚠ CAUTION

Never put your head or hand outside the window.

If your head or hand are outside the window when loading, there is danger of them being hit by falling materials.

It is possible to slide the right window to open or close it.

When opening the window, grip lock (1), release the lock, and slide the window open.

When closing the window, keep lock (1) gripped and slide the window to close it.

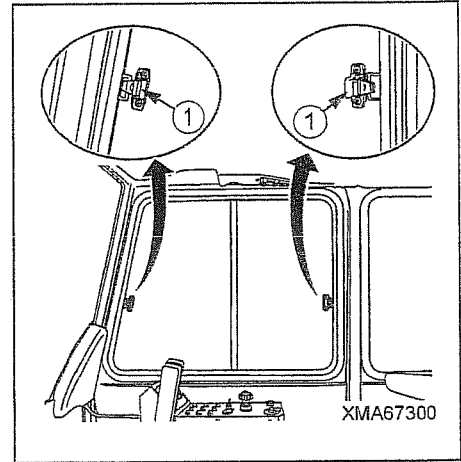

2.16.3 OPENING AND CLOSING REAR WINDOW

⚠ WARNING

- When closing the rear window, pull-in the rear window slowly and be careful not to get your hands caught.
- When the rear window is open, check that it is securely locked.

You can open or close the rear window by pushing or pulling it.

To open the window, remove the lock by pulling lock handle (1) toward you and then push out lock handle (1) backward.

To close the window, pull lock handle (1) toward you and then apply the lock by pushing lock handle (1).

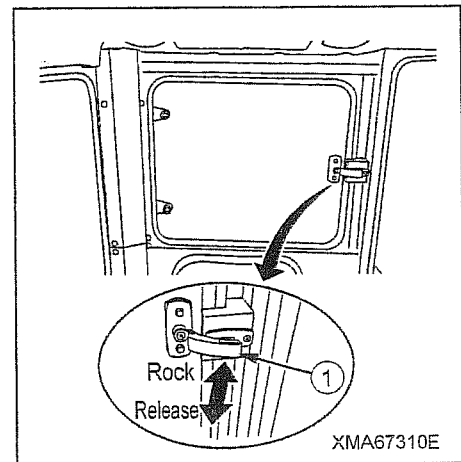

2.17 ACCESSORIES INSIDE CAB

[1] ASHTRAY

This is at the left of the operator's compartment at the cab stay.

When using the ashtray, open the lid. When removing it, pull it up with the lid open.

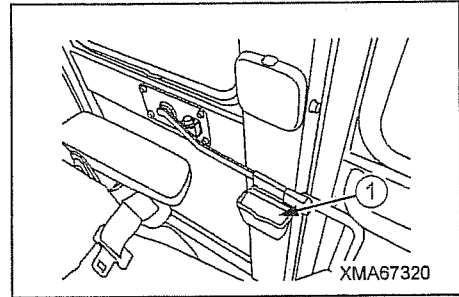

[2] DRINK HOLDER

This is at the left of the operator's compartment at the cab stay.

Use this to keep drink cans or PET bottles.

When using the drink holder, push the button (2) at the top of the drink holder (1) and open the drink holder (1).

When closing the drink holder, return the drink holder (1) to original position and push it.

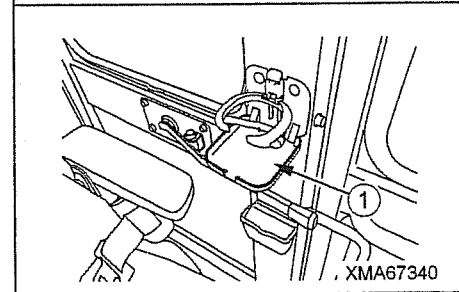
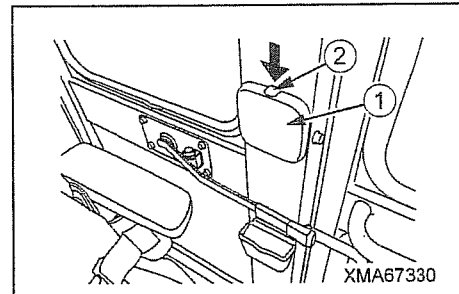

2.18 ENGINE INSPECTION COVER

When carrying out inspection and maintenance of the engine, do as follows to open the inspection cover.

1. Release 2 catches (2) at the left and right of inspection cover (1), then pull handle (3) up.

The cover is held in the open position by the damper.

2. After completion of inspection and maintenance, grip handle (3) of the inspection cover (1) and return it to the frame, then fit left and right catches (2).

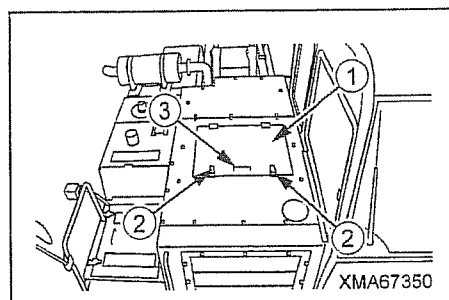

2.19 BATTERY INSPECTION COVER

When carrying out inspection and maintenance of the battery, do as follows to open the inspection cover.

1. Release 2 catches (2) at the front and rear of inspection cover (1), then pull handle (3) up.

The cover is held in the open position by the damper.

2. After completion of inspection and maintenance, grip handle (3) of the inspection cover (1) and return it to the frame, then fit front and rear catches (2).

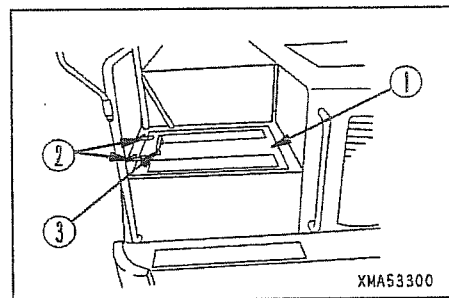

2.20 FRONT GRILL

When cleaning the radiator fins or oil cooler fins, do as follows to remove the front grill.

1. Remove 9 mounting bolts (2), then remove front grill (1).
2. After completion of inspection and maintenance, follow the reverse procedure to removal and install the front grill (1).

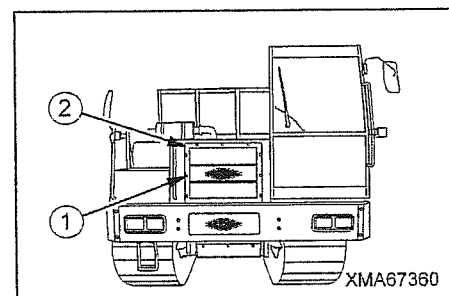

2.21 UNDERCOVER

When changing the coolant, do as follows to remove the undercover.

1. Set a garage jack under the center of undercover (1).
★ Set a wooden block between the jack and the undercover to prevent damage to the undercover.
2. Remove 3 mounting bolts (2), then lower the jack and open undercover (1).
★ If it is necessary to remove undercover (1), use a wooden hammer and knock the rear portion of undercover (1) out to the right side to disconnect the portion connecting it to the frame.
3. After completion of inspection and maintenance, put undercover (1) on the jack, set it at the mounting position under the machine, then tighten mounting bolts (2).

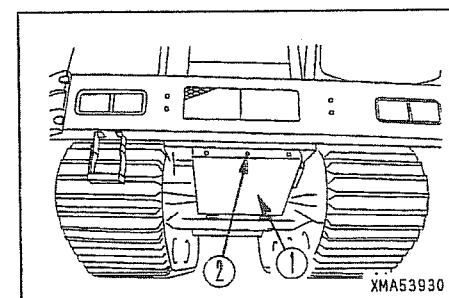

3. OPERATION

3.1 CHECK BEFORE STARTING ENGINE

[1] WALK-AROUND CHECK

⚠ WARNING

- Check carefully that there are no dead leaves, waste paper, oil, grease, or other flammable materials around the battery or the muffler, or other parts of the engine which reach high temperatures. These flammable materials can cause fire.
- Check carefully that there is no leakage of oil or fuel from the hydraulic hoses or fuel hoses. If any cracks, deformation, or other abnormalities are found, repair them immediately. These problems will cause fire, abnormalities in travel, or problems with raising or lowering the dump body.
- Always use the handrails and steps when getting on or off the machine.

Before starting the engine at the beginning of the day's work, look under and around the machine and check the following points.

- Check for dead leaves, waste paper, dust, oil, or grease at places which reach high temperatures.
- Check for loose or missing bolts, nuts, or connecting pins.
- Check for leakage of oil, fuel, or coolant.
- Check for hanging electrical wires or loose connections.

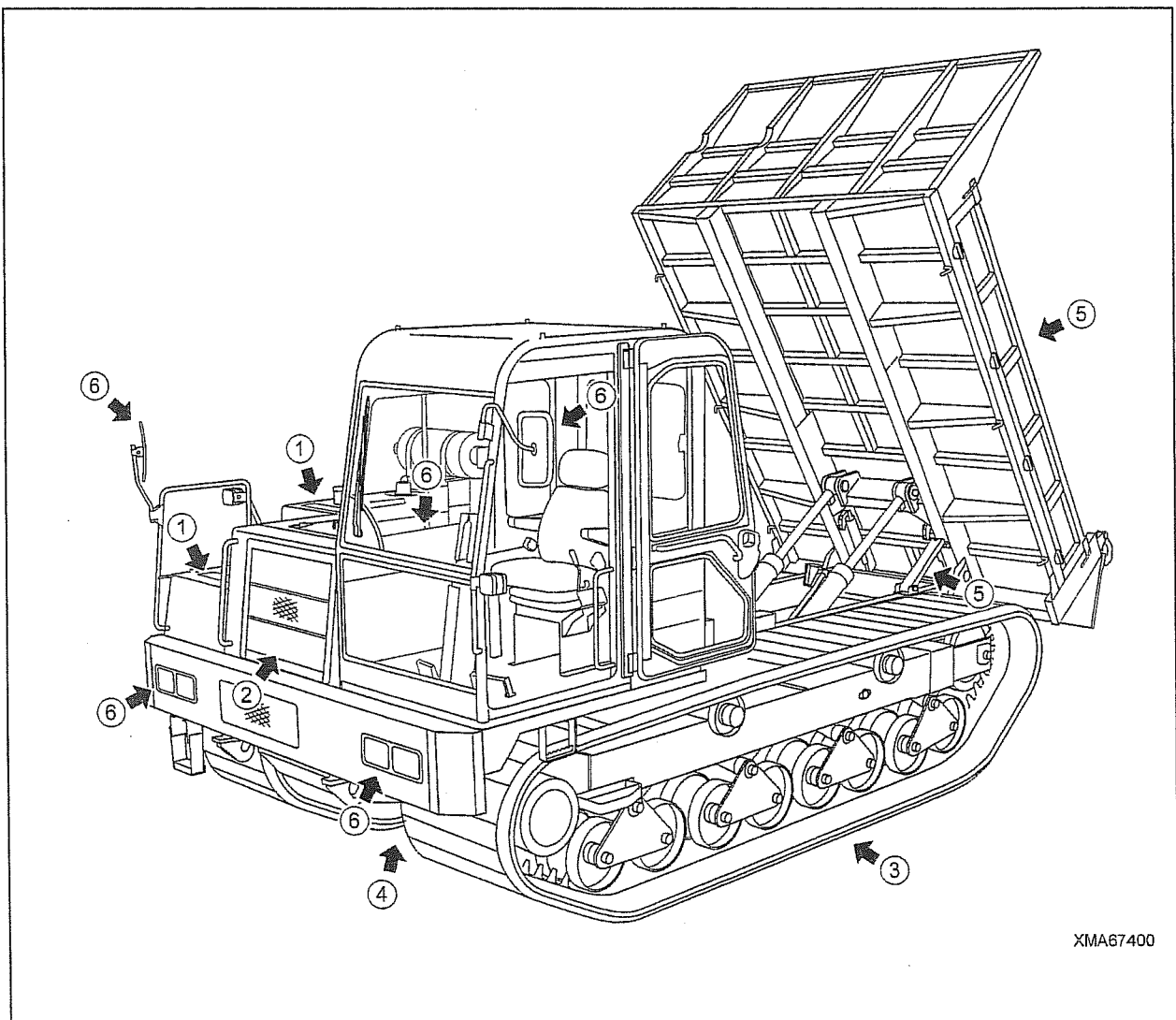

(1) Check around engine

Check for dead leaves, waste paper, dust, oil, grease, or other flammable materials, and check for leakage of fuel, oil, or coolant from the engine. Remove any flammable materials, and repair any abnormalities.

Check for hanging electrical wires, loose connections, or signs of burns around the starting motor, alternator, battery, or battery relay. Repair any abnormality.

(2) Check inside front grill

Check the front surface of the radiator and oil cooler for dead leaves, waste paper, dust, or other flammable materials or materials which cause clogging. Remove any such materials.

(3) Check undercarriage (rubber crawler, track roller, carrier roller, sprocket, idler)

Check for any wear, breaks, or cracks. Check for any loose or missing nuts or bolts. Tighten if necessary and repair any abnormalities.

(4) Check under machine

Check the hydraulic tank and fuel tank for leakage, and check the ground under the machine for traces of oil, fuel, or coolant. If any signs of leakage are found, check for the source of the leakage and repair any abnormality.

Check for loose or missing nuts and bolts from the undercover and other parts, and tighten if necessary.

(5) Check dump body, safety bar

Check for any wear, breaks, or cracks. Check for any loose or missing nuts, bolts, or connecting pins. Tighten if necessary and repair any abnormalities.

Check for any leakage of oil from the hydraulic hoses or hydraulic cylinders, and repair any abnormality.

(6) Check mirrors, lamps, instrument panel

Check for any damage to the mirrors, lamps, or meters, and repair or replace if there is any abnormality.

[2] CHECKS BEFORE STARTING

Before starting the engine at the beginning of the day's work, carry out the following checks before starting and checks when required.

For details of the checks before starting, checks when required, and other maintenance, see "MAINTENANCE".

1. Checks when required

- (1) Check, adjust rubber crawler tension
- (2) Check rubber crawler for damage, wear
- (3) Clean, replace air cleaner
- (4) Clean inside of cooling system and change coolant
- (5) Check, clean radiator fins, oil cooler fins, inter cooler fins, Air conditioner condenser fins
- (6) Check window washer fluid level, add fluid
- (7) Check refrigerant (Gas) volume
- (8) Clean, replace filter of air conditioner
- (9) Fuel system prime

2. Checks before starting

- (1) Check, add coolant
- (2) Check, add fuel
- (3) Check engine lubricating oil level, add oil
- (4) Check, add oil to hydraulic tank
- (5) Check dust indicator
- (6) Drain water, sediment from water separator
- (7) Check and adjust air compressor belt tension
- (8) Check electrical wiring
- (9) Check operation of switches, lamps, gauges
- (10) Check operation of horn, alarm buzzer

[3] ADJUST OPERATOR'S SEAT

WARNING

- Adjust the operator's seat before operations. Always adjust the operator's seat after it has been used by another operator.
- Adjust the operator's seat so that you can operate the travel lever easily with your back against the seat backrest.
- Never adjust the seat when traveling.
- Always lower the armrest and fasten the seat belt before starting operation.
The armrest and seat belt are installed to prevent the danger of the operator falling from the operator's seat if the machine tips at an angle when traveling.

For details of adjusting the operator's seat, see "2.14 OPERATOR'S SEAT".

3.2 OPERATIONS AND CHECKS BEFORE STARTING ENGINE

1. Check that the left and right travel levers are at the N position.

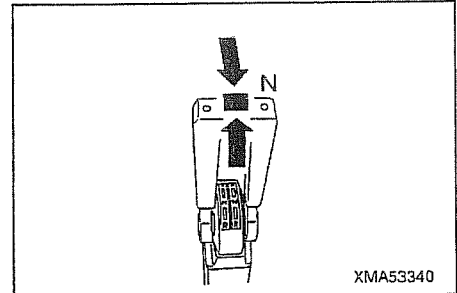

2. Check that the dump body is completely lowered and that dump control lever (1) is at the HOLD position.

3. Check that lock lever (2) of the dump control lever is at the LOCK position.

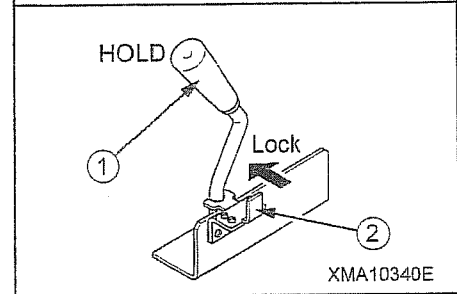

3.3 STARTING ENGINE

⚠ WARNING

Check that there are no persons or obstacles in the surrounding area, then sound the horn and start the engine.

NOTICE

- When starting the engine, be sure to press the parking brake switch to set it to the ON position (Switch built-in lamp light up).
The engine cannot be started without setting the parking brake switch to this ON position.
- Do not try to start the engine immediately when inserting the starting switch.
Turn the switch to the ON position and wait for approx. 2 seconds. During this time, the engine diagnostic lamp [P] (orange) and engine warning lamp [!] (red) on the operating panel box surface light up and then go out.
- Do not crank the starting motor continuously for more than 15 seconds.
If the engine does not start, wait for at least 2 minutes before trying to start again.

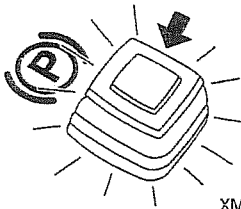

XMA67410

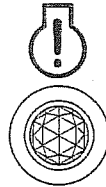

XMA67420



XMA67430

[1] STARTING ENGINE

1. Turn the engine speed control dial to the low speed position.

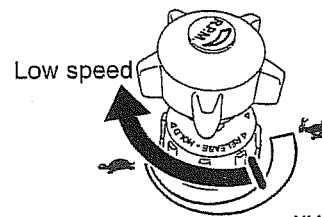

XMA67440E

2. Insert the key in the starting switch, turn it to the ON position, and check that the engine diagnostic lamp (orange) and engine warning lamp (red) light up. Wait for approx. 2 seconds and check that the lamps go out. Then wait until the preheating indicating lamp (orange) turns off. Preheating is complete when the preheating indicator lamp (orange) turns off.

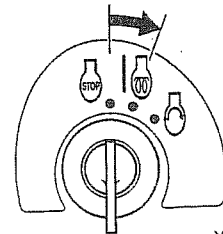

XMA67450

⚠ CAUTION

If the starting motor is turned on by turning the key of the starting switch to the ON position before the engine diagnostic lamp (orange) and the engine warning lamp (red) go out, the starting motor may be damaged and fail.

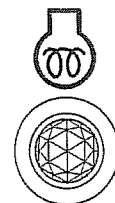

XMA67480

3. Press the parking brake switch to apply the parking brake.

★ Check that the parking brake lamp lights up and that the parking brake buzzer sounds.

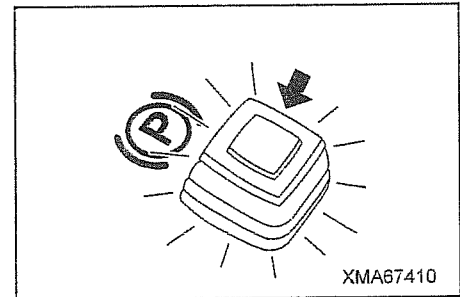

4. Start the engine by turning the key of the starting switch to the START position and activating the starting motor.

! CAUTION

When starting the engine, do not keep turning over the starting motor for more than 15 seconds at a time. If you do so, the starting motor may fail or you may drain the battery.

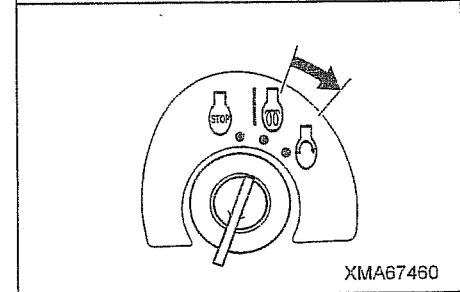

5. If the engine does not start on the first try, return the key of the starting switch to the OFF position, wait for approximately two minutes for the battery to recover and the starting motor to cool down, then turn the key to the ON position again (as explained in Steps 2 and 3).

! CAUTION

If you try to start the engine more times without stopping the starting motor completely, the starting motor pinion and the engine ring gears may be damaged and fail.

6. If the engine does not start even when you have tried to start it twice, there may be some problems with the battery or the engine starting circuit. Check the battery voltage, the electrical wiring of the starting motor, and other factors.

7. After the engine starts, release the key.

★ The key will return automatically to the ON position.

! CAUTION

Never turn the key of the starting switch to the START position while the engine is running. Doing so may damage the starting motor pinion, inside parts, or engine ring gears.

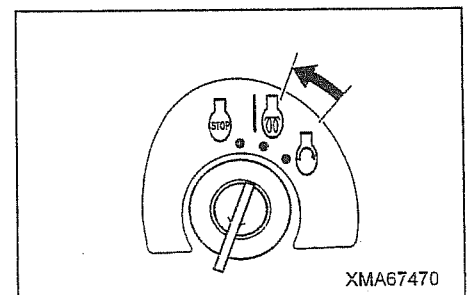

[2] AFTER STARTING (warming-up operation)

NOTICE

After starting the engine, run it under a light load for approximately 15 minutes. Avoid sudden or excessive acceleration of the engine during this period.

After the engine starts, carry out the warming-up operation as follows.

1. Turn the engine speed control dial to the low speed position, and run for approx. 5 minutes under no load.

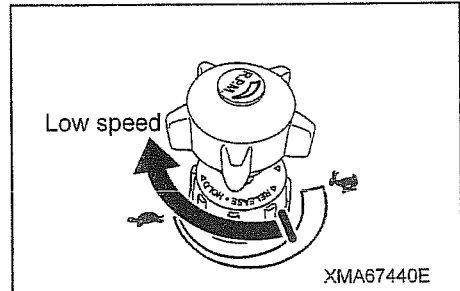

2. Turn the engine speed control dial to the mid-range speed position, and run for approx. 5 minutes under no load.

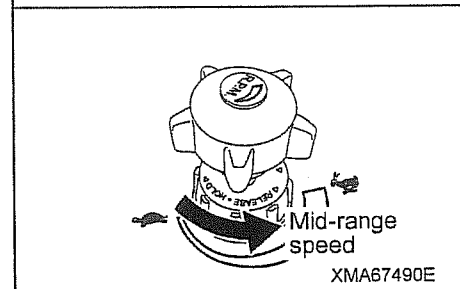

3. Operate dump control lever (1) to the RAISE position, raise the dump body to the maximum height, and run the engine in this condition for approx. 5 minutes.

★ Keep dump control lever (1) at the RAISE position.

4. Keep dump control lever (1) at the RAISE position, turn the engine throttle lever to the right (clockwise) further to run the engine at high speed, and run the engine in this condition for 2 - 5 minutes.

This operation warms up the hydraulic oil and makes the operation of the travel and dump body smooth.

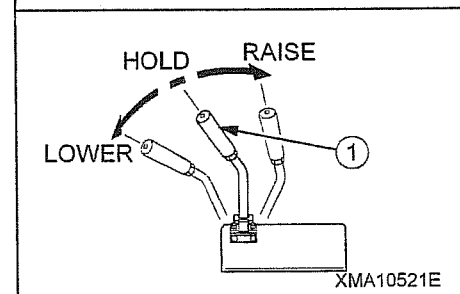

5. Check that the instrument panel gauges, monitor, charge lamps, parking brake buzzer, and backup buzzer work normally.

6. Check that there is no abnormality in the exhaust gas color, engine noise, or vibration.

3.4 MOVING MACHINE OFF

⚠ WARNING

- Check that there is no one in the area around the machine before starting. Check particularly carefully around the dump body at the rear of the machine.
 - When starting the machine off, check that the surrounding area is safe, and sound the horn to inform people that you are starting.
 - When starting the machine off, operate the travel lever gradually. The more the travel lever is operated, the faster the machine will travel. Do not start the machine off suddenly.
 - When starting uphill on slopes, always start in the low speed range and run the engine at high speed. Keep the travel lever as close as possible to the N position.
 - When traveling forward downhill, if the angle of the slope goes above a certain range, the SLOPE CAUTION lamp on the instrument panel lights up and the slope alarm buzzer at the rear of the operator's compartment sounds to warn the operator.
- It is dangerous to start the machine off with the dump body loaded if the slope alarm buzzer sounds. Reduce the engine to low speed, set the travel lever close to the N position, and start the machine off carefully.

1. Turn the engine speed control dial to the mid-range speed position.

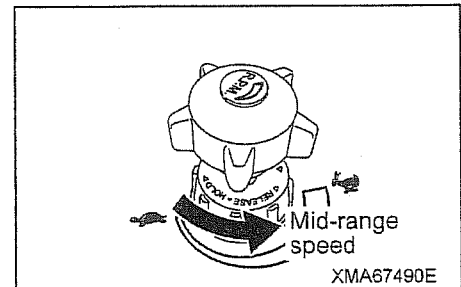

2. Press the parking brake switch to release the parking brake.

- ★ Check that the parking brake lamp goes out and that the parking brake buzzer stops sounding.

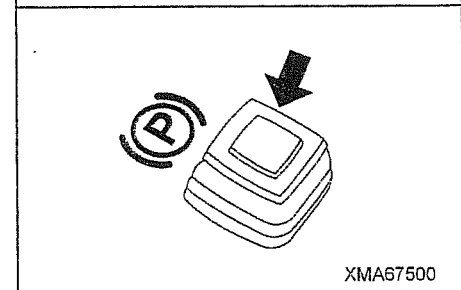

3. Operate the left and right travel levers gradually and start the machine off slowly.

- ★ When starting off in reverse, check that the backup buzzer sounds when the travel lever is operated to the REVERSE position.

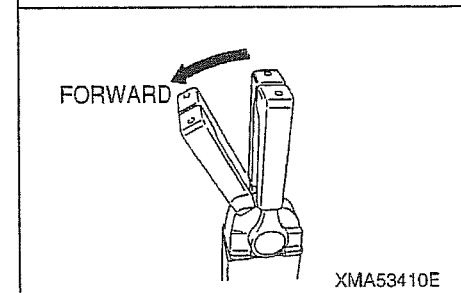

3.5 SHIFTING SPEED RANGE, CHANGING BETWEEN FORWARD AND REVERSE

⚠ WARNING

- When traveling, select a travel speed to match the travel surface and ground condition.
- When traveling on a slope, be sure to set the travel speed range to the low speed range. Also, when traveling on a slope, travel straight forward.
- When going down a slope, always travel in the low speed range. Run the engine at low speed and operate the travel lever a maximum of half way from the N position. Traveling at excessive speed is dangerous and will cause overrunning.
- When traveling up a slope, always travel in the low speed range. Run the engine at the rated speed and keep the travel lever close to the N position. Always travel directly up the slope.
- When traveling forward downhill, if the angle of the slope goes above a certain range, the SLOPE CAUTION lamp on the instrument panel lights up and the slope alarm buzzer at the rear of the operator's compartment sounds to warn the operator.
It is dangerous to start the machine off with the dump body loaded if the slope alarm buzzer sounds. Reduce the engine to low speed, set the travel lever close to the N position, and start the machine off carefully.
- If a dangerous state occurs by any possibility, and when it becomes necessary to stop the machine urgently, press the parking brake switch to set it to the ON (STOP) position or turn the engine starting switch to the OFF position to stop the engine.
- When switching between FORWARD and REVERSE, always stop the machine before shifting direction. If the direction of travel is shifted suddenly between FORWARD and REVERSE, it will cause failures such as reverse rotation of the engine.
- When switching the travel speed range, always stop the machine first before operating the switch.

[1] CHANGING SPEED

The travel speed can be changed by changing the amount that the travel lever is operated.

- The closer the travel lever is to the N position, the lower the travel speed.
- The further the travel lever is from the N position, the higher the travel speed.

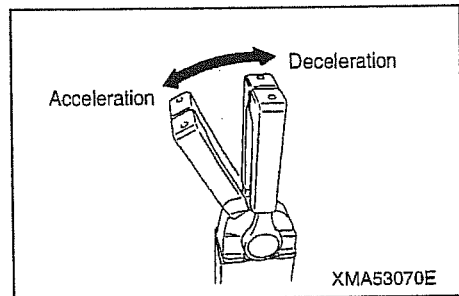

[2] SHIFTING BETWEEN FORWARD AND REVERSE

The direction of travel can be changed by changing the direction of operation of the travel lever.

- When the travel lever is pushed forward, the machine will travel forward.
- When the travel lever is pulled back, the machine will travel in reverse.
★ Check that the backup buzzer sounds when the travel lever is operated to the REVERSE position.

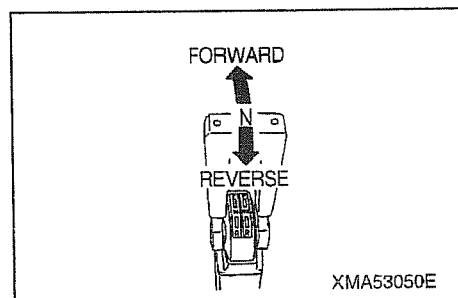

[3] SWITCHING BETWEEN HIGH AND LOW SPEED RANGES

The travel speed range is changed by operating the Hi-Lo speed range selector switch.

- When the switch is pressed to "H" position (forward), the mechanism inside the travel motor is switched and the machine changes to the high speed range.

At the same time, the high-speed lamp lights up to show that the machine is traveling in the high speed range.

- If the switch is pressed to "L" position (backward), the mechanism inside the travel motor returns to its original position, and the machine travels in the low speed range.

At the same time, the high-speed lamp goes out to show that the machine is traveling in the low speed range.

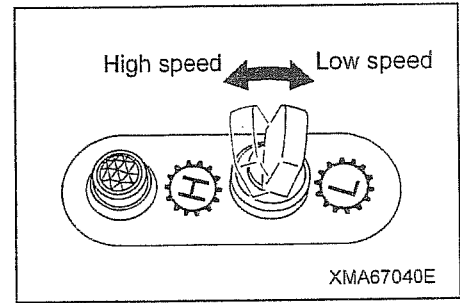

3.6 STEERING MACHINE

⚠ WARNING

- Do not turn the machine sharply at high speed; do not carry spin turns unless necessary. This will damage the crawler and hydraulic equipment, and there is also danger that the machine may hit other objects.
- The machine may slip to the side if it is turned on a slope, so avoid turning on slopes as far as possible. Be particularly careful about turning on soft ground or clay ground.
- When traveling forward downhill, if the angle of the slope goes above a certain range, the SLOPE CAUTION lamp on the instrument panel lights up and the slope alarm buzzer at the rear of the operator's compartment sounds to warn the operator.
It is dangerous to turn with the dump body loaded if the slope alarm buzzer sounds. Dump the load immediately to empty the dump body, then turn slowly.
- If a dangerous state occurs by any possibility, and when it becomes necessary to stop the machine urgently, press the parking brake switch to set it to the ON (STOP) position or turn the engine starting switch to the OFF position to stop the engine.

[1] GRADUAL TURN

The radius of the turn is determined by the difference in the amount that the left and right travel levers are operated. The larger the difference between the left and right travel levers, the smaller the radius of the turn will be.

[Turning while increasing speed]

- To make a gradual turn when traveling forward, push the travel lever forward a small amount on the opposite side to the direction of the turn.
To make a rapid turn when traveling forward, push the travel lever forward a large amount on the opposite side to the direction of the turn.
★ When turning to the left, push the right travel lever forward.
When turning to the right, push the left travel lever forward.
- To make a gradual turn when traveling in reverse, pull the travel lever back a small amount on the opposite side to the direction of the turn.
To make a rapid turn when traveling in reverse, pull the travel lever back a large amount on the opposite side to the direction of the turn.
★ When turning to the left, pull the right travel lever back.
When turning to the right, pull the left travel lever back.

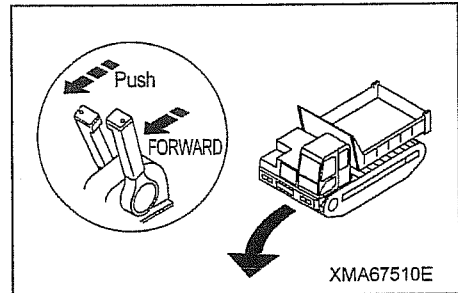

[Turning while decreasing speed]

• To make a gradual turn when traveling forward, pull the travel lever back a small amount in the direction of STOP on the same side as the direction of the turn.

To make a rapid turn when traveling forward, pull the travel lever back a large amount on the same side as the direction of the turn.

★ When turning to the left, pull the left travel lever back towards STOP.

When turning to the right, pull the right travel lever back towards STOP.

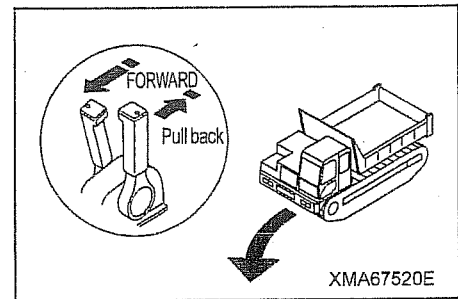

• To make a gradual turn when traveling in reverse, push the travel lever back a small amount in the direction of STOP on the same side as the direction of the turn.

To make a rapid turn when traveling forward, push the travel lever back a large amount on the same side as the direction of the turn.

★ When turning to the left, push the left travel lever back towards STOP.

When turning to the right, push the right travel lever back toward

[2] PIVOT TURN

Operate the travel lever on one side and set the other lever at the N position.

Only the crawler on the side that is operated will rotate, so the machine will make a pivot turn.

★ To turn to the left when traveling forward, push the right travel lever forward.

To turn to the right when traveling forward, push the left travel lever forward.

★ To turn to the left when traveling in reverse, pull the right travel lever back.

To turn to the right when traveling in reverse, pull the left travel lever back.

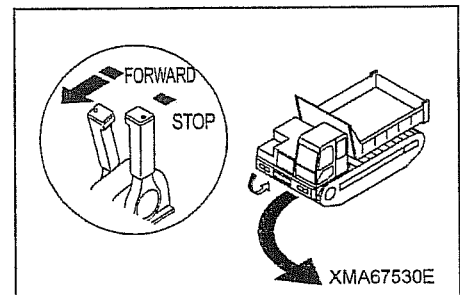

[3] SPIN TURN (Counter rotation turn)

Operate the left and right travel levers in opposite directions. The left and right crawlers will rotate in opposite directions and the machine will make a spin turn.

★ To turn to the left, push the right travel lever forward and pull the left travel lever back.

★ To turn to the right, push the left travel lever forward and pull the left travel lever back.

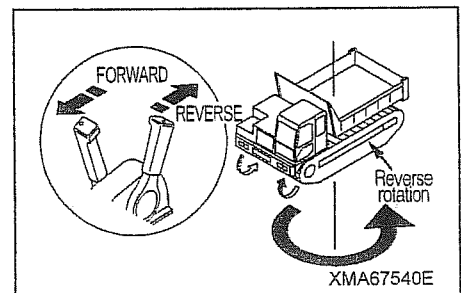

3.7 STOPPING MACHINE

WARNING

- Avoid stopping suddenly. Always leave room to spare when stopping.
- Never use the parking brake to stop the machine. Using the parking brake will cause the machine to stop suddenly and will also damage the machine.
- When stopping the machine, return the left and right travel levers at the same time to the N position. If the left and right levers are not operated at the same time, there is danger that the brakes will pull to one side.
- When stopping, do not return the travel lever past the N position. If the travel lever is moved past the N position, it will cause failures such as reverse rotation of the engine.

Return the left and right travel levers to the N position.
The hydraulic brake is automatically applied and the machine will stop.

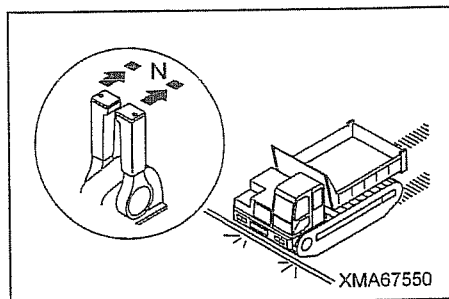

3.8 EMERGENCY STOPPING MACHINE

WARNING

If a dangerous state occurs by any possibility, and when it becomes necessary to stop the machine urgently, press the parking brake switch to set it to the ON (STOP) position or turn the engine starting switch to the OFF position to stop the engine.

There are following 2 methods when making an emergency stop of the machine.

- Press the parking brake switch to apply the parking brake.
 - ★ Check that the parking brake lamp lights up and that the parking brake buzzer sounds.
- Turn back the starting switch key to the OFF position to stop the engine.

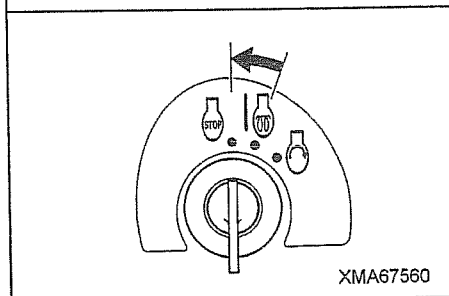
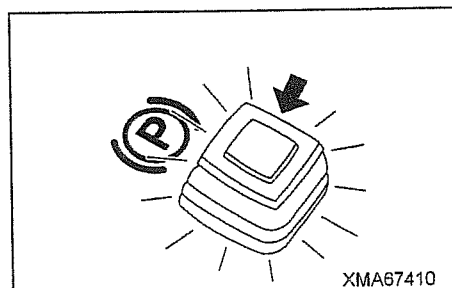

3.9 PARKING MACHINE

⚠ WARNING

Choose firm, level ground to park the machine.

If the machine must be parked on the slope, apply the parking brake and block the tracks to prevent the machine from moving.

Press the parking brake switch to apply the parking brake.

★ Check that the parking brake lamp lights up and that the parking brake buzzer sounds.

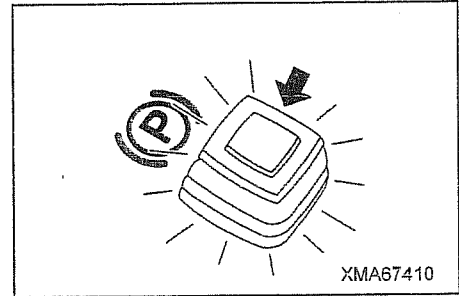

3.10 STOPPING ENGINE

NOTICE

- Do not stop the engine before it has properly cooled down. Stopping the machine before it cools down will shorten the service life of the engine. Never stop the engine suddenly except in emergency.
- If the engine has overheated, do not stop it suddenly. Run the engine at a mid-range speed and gradually cool it down before stopping the engine.

1. Turn the engine speed control dial to the low speed position to reduce the engine speed and run the engine at idling for 5 minutes to cool the engine down.

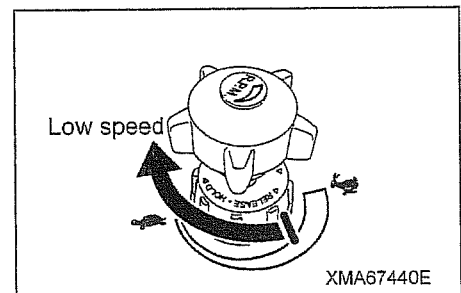

2. Return the key in the starting switch to the OFF position.

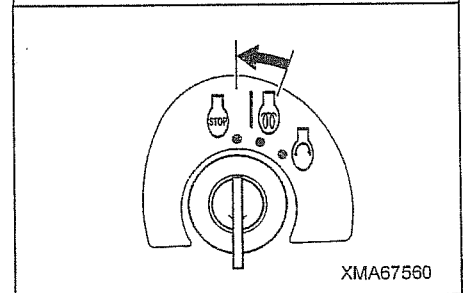

3.11 CHECKS AFTER STOPPING ENGINE

- Carry out a walk-around check and check the undercarriage, dump body, and bodywork; check also for leakage of oil and water. If any abnormality is found, repair it.
- Fill the fuel tank with fuel.
- Remove any dead leaves, waste paper, or other flammable materials from around the engine that may cause fire.
- Remove any mud or snow stuck to the undercarriage or dump body.

3.12 LOCKING

To prevent vandalism, the following locations can be locked.

(1) Cab door

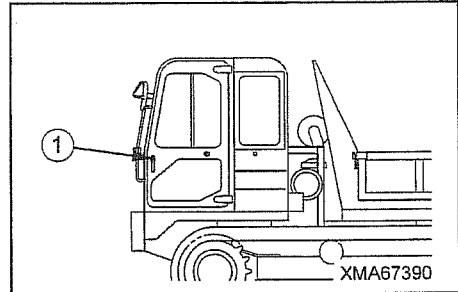

(2) Fuel tank filler cap

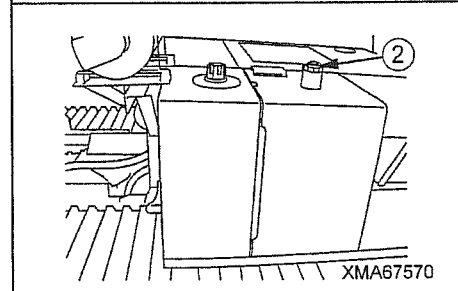

3.13 PRECAUTIONS WHEN TRAVELING

⚠ WARNING

Always follow these precautions when traveling. Failure to follow these precautions may lead to a serious injury or accident.

[1] PERMISSIBLE WATER DEPTH

When operating in water, do not let the bottom surface of the track frame.

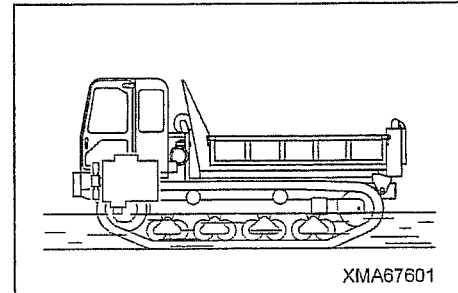

[2] USE OF PARKING BRAKE

When stopping the machine, return the travel lever to the N position. The hydraulic brake inside the HST is automatically applied to stop the machine.

Never use the parking brake to stop the machine.

Using the parking brake will not only stop the machine suddenly, but will also cause failure of the travel motor.

Do not use the parking brake to stop the machine except when it is necessary to stop the machine suddenly in emergencies.

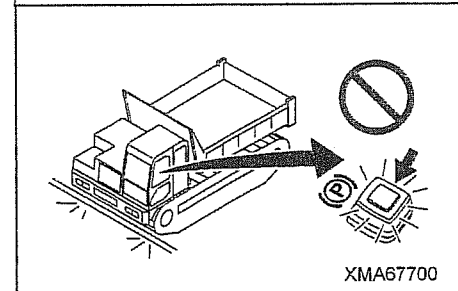

[3] PAY ATTENTION TO ANGLE ALARM BUZZER

If the angle exceeds a certain angle on slopes, the SLOPE CAUTION lamp on the control panel box lights up and the slope alarm buzzer under the operator's seat sounds to warn the operator. It is dangerous to travel with the dump body loaded if the angle alarm buzzer sounds. Reduce the engine to low speed, set the travel lever close to the N position, and drive the machine carefully.

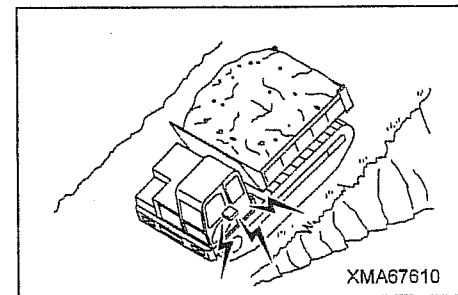

[4] PRECAUTIONS WHEN ENGINE STOPS ON SLOPES

If the engine stops on a slope, do as follows.

1. Return the travel lever to the N position.
2. Press the parking brake switch to the ON position.
 - ★ Check that the parking brake lamp lights up.
3. Start the engine again.

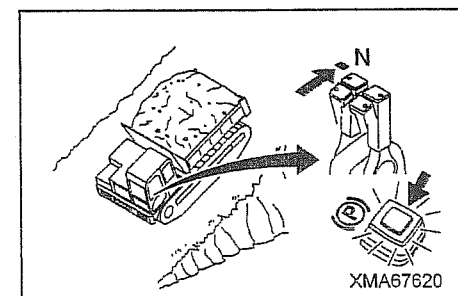

[5] PRECAUTIONS WITH FUEL LEVEL ON SLOPES

If the fuel level in the fuel tank is low and the machine is on a slope or there is swaying, the engine may suck in air, which may cause the engine to stop.

Always maintain a sufficient level of fuel in the fuel tank.

[6] PRECAUTIONS FOR OIL LEVELS ON SLOPES

When traveling or carrying out operations on steep slopes, check the oil level in the hydraulic tank and engine, and add oil to the high level.

This will prevent failure caused by lack of oil.

4. HANDLING DUMP BODY

4.1 OPERATING DUMP BODY

⚠ WARNING

- Always stop the machine before operating the dump body to the dump position.
- Position a signalman to ensure safety in the surrounding area, and follow his signals when carrying out the dumping operation.
- Always operate the dump control lever slowly. If the dump body is suddenly stopped or it is allowed to hit the frame when it is lowered, it will cause failures and will also cause problems of safety in the surrounding area.
- When leaving the operator's compartment with the dump body raised, always lock the dump control lever. In addition, use the safety bar to prevent the dump body from coming down. Even when the engine is stopped, it is possible to lower the dump body.

Operate the dump body as follows.

- ★ The further the dump control lever is operated, the faster the dump body will move.
 - ★ When the dump control lever is released, it automatically returns to the HOLD position.
1. Stop the machine completely. For details, see "3.7 STOPPING MACHINE".
 2. Turn the engine speed control dial to the high speed position and raise the engine speed sufficiently.
 3. Pull the dump control lever (1) up. The dump body will rise.
 - ★ When the dump body comes near to the max. height, push the dump control lever down to reduce the speed of the dump body.
 4. Push the dump control lever (1) down. The dump body will go down.
 - ★ When the dump body comes near to the frame, pull the dump control lever up to reduce the speed of the dump body.

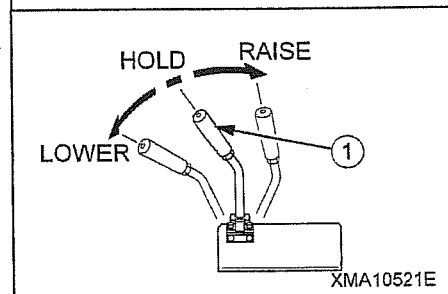
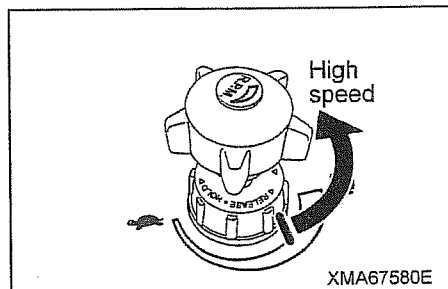

4.2 LOCKING DUMP CONTROL LEVER

⚠ WARNING

If you leave the operator's seat with the dump track raised, always lock the dump control lever. The dump body can be lowered even when the engine is stopped.

Lock the dump control lever as follows.

1. Release dump control lever (1) and set it to the HOLD position.
2. Push lock lever (2) to inside. This will lock dump control lever (1).
3. To release the lock from the dump control lever, pull lock lever (2) to the outside. This will release the lock from dump control lever (1).

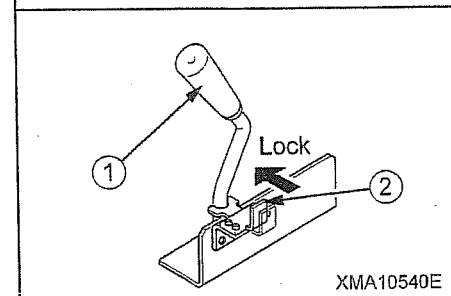
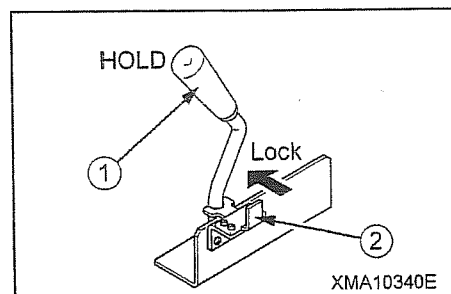

4.3 OPERATING SAFETY BAR

⚠ WARNING

- If it is necessary to go under the dump body to carry out inspection and maintenance, always use the safety bar to prevent the dump body from coming down.
- When using the safety bar, check that the bar is fitted securely to the dump body holder.
- The safety bar is a safety device used during inspection and maintenance. Do not use the safety bar to support the dump body when replacing the dump cylinder, valve, hydraulic hoses, or other equipment. In such cases always support the dump body with a crane.

NOTICE

When setting the safety bar in position, never start the engine and operate the dump control lever to the LOWER position. If this is done, the safety bar will hit the dump body and may break.

[1] INSTALLING SAFETY BAR

1. Raise the dump body to at least 45 degrees. For details, see "4.1 OPERATING DUMP BODY".
2. Raise safety bar (1) and set it in holder (2) in the bottom surface of the dump body.
3. Stop the engine and push the dump control lever down. The dump body will go down under its own weight.
★ If the dump body does not go down under its own weight, start the engine and operate the dump control lever to lower it to a point where the dump body and safety bar still do not come into contact.

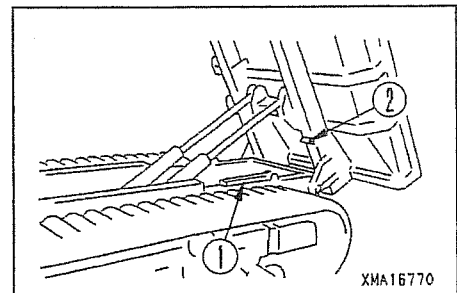

[2] REMOVING SAFETY BAR

1. Raise the dump body fully. For details, see "4.1 OPERATING DUMP BODY".
2. Return safety bar (1) to the fixed position on top of the frame.

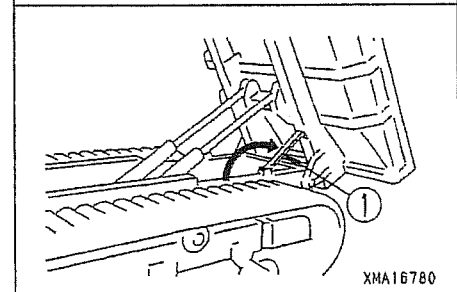

4.4 PRECAUTIONS DURING OPERATION

WARNING

Always follow these precautions when carrying out operations.
Failure to follow these precautions may lead to a serious injury or accident.

[1] PRECAUTIONS FOR JOBSITES

- As far as possible, select firm, level ground.

When working on slopes or extremely uneven ground, the change in the center of gravity when the dump is operated may cause the machine tip over.

- As far as possible, avoid the edge of cliffs or ground which may collapse.

If work must be carried out in such places, set up blocks to prevent the machine from going near the edge or near retaining walls, or position a signalman and take other necessary steps for ensuring safety.

- When dumping a load from a high point, always position a signalman and follow the signals.

The signalman must always check the safety of the dumping point carefully.

[2] PRECAUTIONS FOR LOAD

- Do not overload the machine.

Do not fit side racks or plates, or make other modifications to extend the size of the dump body to increase the load.

- When loading the dump body, always spread the load uniformly.

Loading the dump body unevenly will cause instability and may cause the machine to tip over.

- Be careful not to let the loading bucket or crane hook hit the dump body or flaps.

- When loading large rocks, first load the dump body with fine soil, then load the rocks on top of that.

- When handling long objects, such as logs or steel beams, load carefully and pay careful consideration to the center of gravity so that the load does not collapse or sway excessively during hauling operations.

Tie down such loads securely with rope.

If necessary, use blocks and take steps to prevent the rope from slipping.

- When loading stacks of U-shaped ditch liners or concrete blocks, lay a steel sheet and secure with rope, and take other steps to prevent the load from slipping.

5. MANUAL RELEASE OF PARKING BRAKE

5.1 OUTLINE OF PARKING BRAKE

The parking brake is built into the left and right travel motors.

When the parking brake is released under normal conditions, the parking brake switch is operated and uses the hydraulic power generated when the engine is running.

If the engine is stopped and there is no hydraulic power, even if the parking brake switch is set to the RUN position, the parking brake will remain applied.

If any failure should occur in the HST (pump, motor) or engine, and the engine cannot be started again, release the parking brake manually.

5.2 METHOD FOR MANUAL RELEASE OF PARKING BRAKE

⚠ WARNING

- When releasing the parking brake manually, loosen the hydraulic tank cap slowly, then remove it and wait for the oil temperature to go down fully.
- The circuit inside the HST is still under internal pressure, so when removing plugs and hoses, do not stand directly in front of them; loosen them gradually before removing.
- When the hoses are removed, a large quantity of oil will come out, so always catch the oil in an oil container.
- When releasing the parking brake manually, the operation involves dangerous work, such as removing high-pressure hoses, so always pay careful attention to safety during the operation and contact your distributor before starting the operation.

[1] PROCEDURE FOR RELEASING PARKING BRAKE MANUALLY.

When releasing the parking brake manually, do as follows.

1. Remove the undercover. For details, see "2.20 UNDER COVER".
2. Remove plugs (1) (2 on each side) from the left and right travel motors.
3. Set washer (3) to the bolt (2) (M10 x 100), then pass the bolt through the plug hole.
4. Turn bolt (2) clockwise to screw it into the thread of brake piston (4) inside the travel motor.
★ Screw in bolt (2) until the seat surface of washer (3) contacts the cover.
5. Turn bolt (2) two more turns clockwise.
★ When this is done, the brake piston is pulled towards the cover and the parking brake is released.

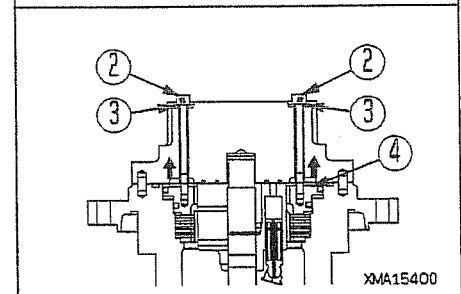
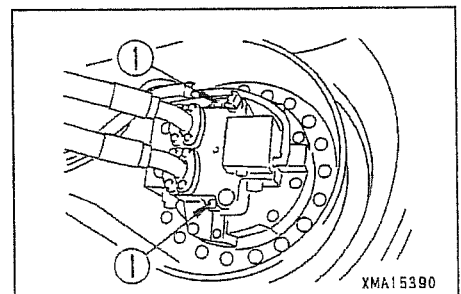

[2] PREPARATIONS FOR MOVING FAILED MACHINE

NOTICE

When moving a machine which has had its parking brake released manually, the distance of movement should be only the few meters needed to move it to a safe place.

Moving the machine a long distance will cause failure of the HST.

When moving a failed machine, carry out the following preparatory work.

Go under the machine and turn adjustment screw (7) of multi-function valves (6) (4 places) at the bottom of main pump (5) approx. 3.5 turns to the left.

The oil inside the HST circuit will flow freely.

★When starting normal operations again after completion of repair of the machine, always turn adjustment screw (7) of multi-function valve (6) approx. 3.5 turns to the right to return it to the original position.

If the multi-function valve is not returned to the original condition, the machine will not move.

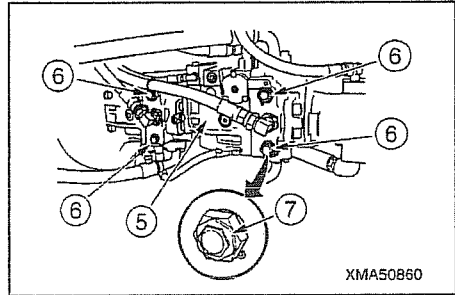

6. HANDLING RUBBER CRAWLER

6.1 FEATURES OF RUBBER CRAWLER

The properties of the material used for the rubber crawlers gives it many advantages, such as low vibration, high drawbar pull, and ease of handling.

Make sure that you fully understand the advantages of rubber crawlers, and follow the content of "6.2 PROHIBITED OPERATIONS FOR RUBBER CRAWLER" and "6.3 PRECAUTIONS WHEN USING RUBBER CRAWLER" to extend the service life of the rubber crawlers and to realize the maximum advantages of the rubber crawler.

6.2 PROHIBITED OPERATIONS FOR RUBBER CRAWLER

- Turning operations or other operations on hard rocky ground, extremely rough rockbed, in places with many tree stumps, on steel rods or steel scrap, or places with many sharp objects, or on concrete surfaces will cause damage to the rubber shoe.
- On riverbeds or other jobsites where there are large numbers of rocks of different sizes, the rocks will get caught in the rubber shoe and damage the shoe or cause it to come off the roller.
- Do not let oil, fuel, or chemical solvent get on the rubber shoe. Do not travel in places where there is oil on the road surface.
- Do not let the machine enter any place where the ground is at high temperature, such as on asphalt or steel plates that have been left in the sun or in places where there have been fires.
- When putting the machine in long-term storage (3 months or more), store the machine indoors where it is out of direct sunlight and rain.

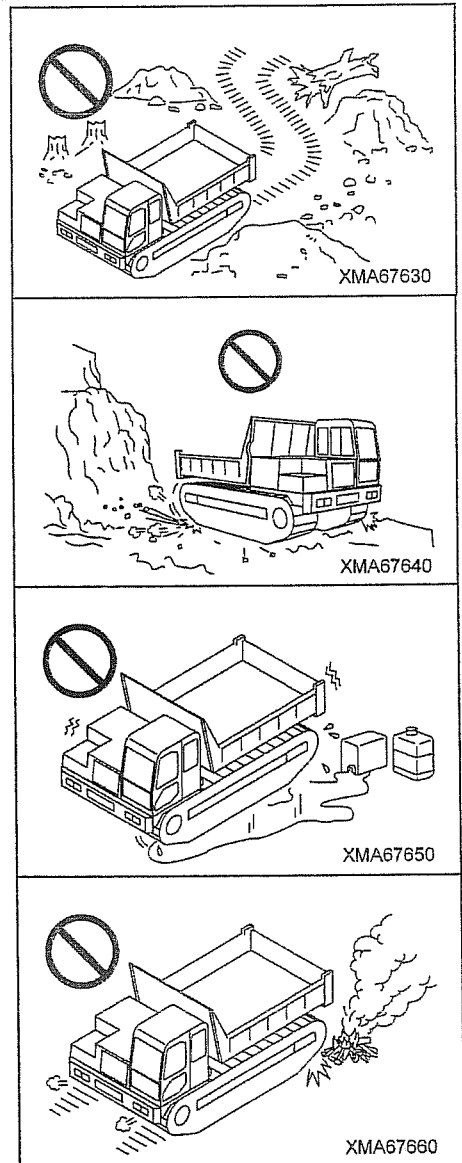

6.3 PRECAUTIONS WHEN USING RUBBER CRAWLER

⚠ WARNING

Always follow these precautions when using rubber crawlers. Failure to follow these precautions may lead to a serious injury or accident.

- Do not make sharp turns on concrete surfaces.
- Do not operate the machine in such away that the rubber track scrapes against concrete walls.
- Sudden changes of direction will cause damage and premature wear to the rubber shoes, so avoid sudden turns as far as possible.
- Avoid traveling and turning in places where there is a large ridge. When traveling over a ridge, approach the ridge at a right angle.
- As far as possible, avoid handling loads that produce oil when crushed (soy beans, corn, vegetables, etc.). If the machine is used for handling such products, be sure to wash the track thoroughly after use.
- When handling loads such as salt, ammonium sulphate, potassium chloride, potassium sulphate, or phosphates, be sure to wash the track thoroughly after use.
- On snow or frozen road surfaces, the rubber shoe will slip very easily. Be careful also of slipping when traveling or operating on slopes.
- To prevent the rubber shoe from coming off, always check that the tension is correct.
If the tension is too loose, the rubber shoe will come off and there will be abnormal wear of the steel core and sprocket.
If the tension is too tight, the travel speed will be reduced and there will be premature wear or damage to the undercarriage.

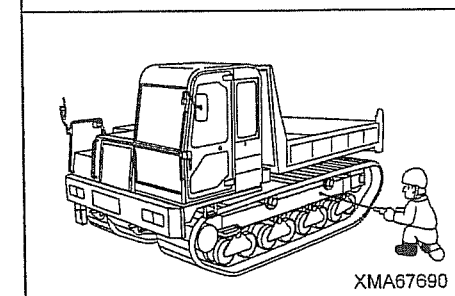
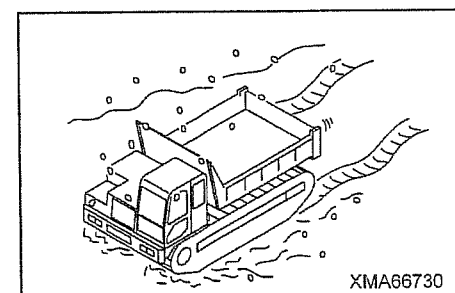
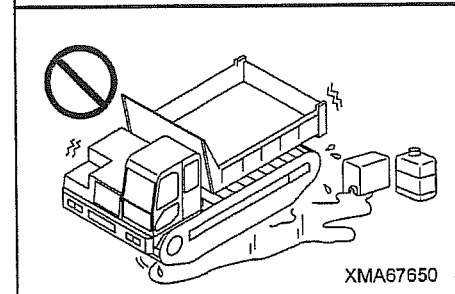
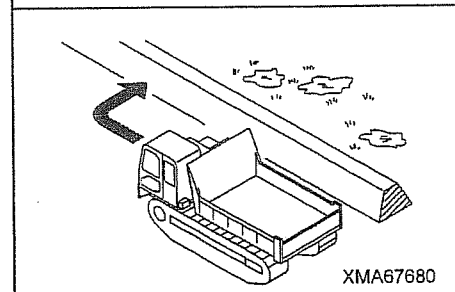
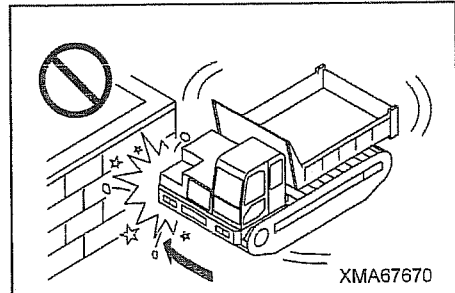

7. TRANSPORTATION

7.1 LOADING, UNLOADING WORK

! WARNING

- Make sure the ramp has sufficient width, length and thickness to enable the machine to be safely loaded and unloaded. If the ramp sags appreciably, reinforce it with blocks, etc.
- When loading and unloading the machine, park the trailer on a flat firm roadbed. Keep a fairly long distance between the road shoulder and the machine.
- Remove the mud from the undercarriage to prevent the machine from slipping to the side on slopes. Be sure the ramp surface is clean and free of grease, oil, ice and loosen materials.
- Never change the direction of travel when on the ramps. If it is necessary to change direction, drive off the ramps and correct the direction, then drive on to the ramps again.

When loading or unloading, always use ramps or a platform and carry out the operations as follows.

1. Apply the brake securely to the truck or trailer and put blocks under the tires to prevent the machine from moving.
2. Set the ramps so that the center of the machine is aligned with the truck or trailer, and fix securely in position.
 - ★ Check that the left and right ramps are at the same height.
3. Align the machine with the ramps, and drive up or down the ramps slowly to the load or unload the machine.
4. To prevent the machine from moving during transportation, put wooden blocks under the front and rear of the rubber crawler and secure the machine with chains or wire rope.

Be particularly careful to secure it so that it cannot slip to the side.

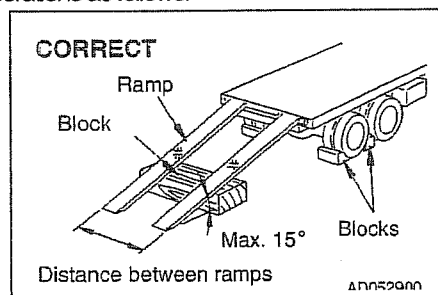

7.2 PRECAUTIONS FOR LOADING

! WARNING

When loading and unloading the machine, park the trailer on a flat firm roadbed. Keep a fairly long distance between the road shoulder and the machine.

After loading the specified position, secure the machine as follows.

1. Lower the dump body slowly.
2. Push the parking brake switch in to apply the parking brake.
3. Return the engine throttle lever to the low-speed position, turn the starting switch to the OFF position and stop the engine. Remove the starting key.
4. When transporting the machine, place rectangular timber underneath the front and rear track shoes to prevent the machine from moving about. Also, hold it down with chains or rope. Be particularly careful to ensure that the machine does not slip sideways.

7.3 PRECAUTIONS FOR TRANSPORTATION

! WARNING

Determine the route for transporting the machine by taking into account the width, height and weight of the machine.

Obey all state and local laws governing the weight, width and length of a load. Observe all regulations governing wide loads.

8. COLD WEATHER OPERATION

8.1 PRECAUTIONS FOR LOW TEMPERATURE

If the temperature becomes low, it becomes difficult to start the engine, and the coolant may freeze, so do as follows.

[1] FUEL AND LUBRICANTS

Change to fuel and oil with low viscosity for all components.

For details of the specified viscosity, see "MAINTENANCE 3. USE OF FUEL, COOLANT AND LUBRICANTS ACCORDING TO AMBIENT TEMPERATURE".

[2] COOLANT MIXTURE RATIO IN COOLING WATER

WARNING

Antifreeze is flammable, so keep it away from flames. Never smoke when handling antifreeze.
Antifreeze is added to the coolant to prevent the water from freezing when the machine is not being used.

NOTICE

Never use methanol, ethanol, or propanol-based antifreeze.

To prevent engine overheating, rust, corrosion or freezing in the cooling system, use a mixture of long life coolant with tap water for engine cooling water.

The coolant serves anti-rust, anti-corrosion, and antifreeze. It should be used year around.

The coolant mixture ratio must be 30% or higher to ensure anti-rust and anti-corrosion properties.

[COOLANT MIXTURE RATIO]

Use the following table as a guide. The table shows examples when the amount of cooling water is "21 liters (5.55 US gal) [4.62 UK gal]".

Item	Unit				
Min. temperature	Deg C	-10	-15	-20	-25
	Deg F	14	5	-4	-13
Amount of coolant	Litter	6.3	6.3	7.4	8.4
	US gal	1.66	1.66	1.96	2.22
	UK gal	1.39	1.39	1.63	1.85
Amount of cooling water	Litter	14.7	14.7	13.6	12.6
	US gal	3.89	3.89	3.59	3.33
	UK gal	3.23	3.23	2.99	2.77
Coolant mixture ratio	%	30	30	35	40

When the vehicle is delivered, the cooling water is mixed with 30% long life coolant of the brand as shown below.

★COOLANT GREEN (ENEOS): Non-amine type

[3] BATTERY

⚠ DANGER

- To avoid gas explosions, do not bring fire or sparks near the battery.
- Battery electrolyte is dangerous. If it gets in your eyes or on your skin, wash it off with large amounts of water, and consult a doctor.

When the ambient temperature drops, the capacity of the battery will also drop. If the battery charge ratio is low, the battery electrolyte may freeze. Maintain the battery charge as close as possible to 100%, and insulate it against cold temperature so that the machine can be started easily the next morning.

Measure the specific gravity and calculate the rate of charge from the following conversion table.

Rated of charge (%)	Temp. of battery electrolyte [deg C (deg F)]			
	20 (68)	0 (32)	-10 (14)	-20 (-4)
100	1.28	1.29	1.30	1.31
90	1.26	1.27	1.28	1.29
80	1.24	1.25	1.26	1.27
75	1.23	1.24	1.25	1.26

8.2 AFTER COMPLETION OF WORK

To prevent mud, water, or the undercarriage from freezing and making it impossible for the machine to move on the following morning, always observe the following precautions.

- Mud and water on the machine body should be completely removed. This is to prevent damage to the seal caused by mud or dirt getting inside the seal with frozen drops of water.
- Park the machine on concrete or hard ground. If this is impossible, park the machine on wooden boards.
- Open the drain valve and drain any water collected in the fuel system to prevent it from freezing.
- As the battery capacity drops markedly in low temperatures, cover the battery or remove it from the machine, keep it in a warm place, and install it again the next morning.
- If electrolyte level is found low, add distilled water in the morning before beginning work. Do not add the water after day's work so as to prevent fluid in the battery from freezing in the night.

8.3 AFTER COLD WEATHER

When season changes and the weather becomes warmer, do as follows.

- Replace the fuel and oil for all parts with oil of the viscosity specified.
For details, see "MAINTENACE 3. USE OF FUEL, COOLANT AND LUBRICANTS ACCORDING TO AMBIENT TEMPERATURE".
- If for any reason permanent antifreeze cannot be used, and an ethyl glycol base antifreeze (winter, one season type) is used instead, or if no antifreeze is used, drain the cooling system completely, then clean out the inside of the cooling system thoroughly, and fill with fresh water.

9. LONG-TERM STORAGE

9.1 BEFORE STORAGE

When putting the machine in storage for more than one month, do as follows.

- After every part is washed and dried, the machine shall be housed in a dry building. Never leave it outdoors.
In case it is indispensable to leave it outdoors, park the machine on the flat ground and cover it with canvas etc.
- Completely fill the fuel tank, lubricate and change the oil before storage.
- Apply a thin coat of grease to metal surface of the hydraulic piston rods and the idler adjusting rods.
- Disconnect the negative terminals of the battery and cover it, or remove it from the machine and store it separately.
- If the temperature will go below 0°C, add anti-freeze to the cooling water.
When not using anti-freeze, drain all the cooling water, and put a "No coolant" sign in the operator's compartment.

9.2 PRECAUTIONS DURING STORAGE

WARNING

If warming-up operation must be carried out inside a building, open the windows and doors to ensure good ventilation and prevent gas poisoning.

- When the machine is in long-term storage, start the engine once a month and carry out the warming-up operation thoroughly.
In addition, move the machine for a short distance, and carry out the raise and lower operation thoroughly for the dump body.
- ★ If the cooling water has been drained from the machine, always fill with cooling water before starting the engine.
- ★ Before operating the dump body, wipe off the coat of grease from the piston rods of the hydraulic cylinders.

9.3 PRECAUTIONS AFTER STORAGE

Carry out the following procedure when using the machine after long-term storage.

- Wipe off the coat of grease from the piston rods of the hydraulic cylinders.
- Remove the drain plugs from the hydraulic tank, fuel tank, engine oil pan, and travel motors, and drain the water.
- Drain the water from the engine oil filter, fuel filter, and hydraulic line filter.
- Carry out the checks before starting and warm up the machine thoroughly, then check all parts of the machine carefully.

10. HANDLING BATTERY

When handling batteries, always do as follows.

⚠ DANGER

- Before working with the battery, stop the engine and turn the key in the starting switch to the OFF position.
- When working with the battery, always wear safety glasses.
- Batteries generate hydrogen gas, so there is danger of explosion. Do not smoke, use a lighter, or create any spark near the battery.
- Battery electrolyte contains sulphuric acid. If you get acid on yourself, immediately flush the area with large amounts of water. If acid gets into your eyes, flush them immediately with large amounts of fresh water, then go to a doctor for treatment.
- When removing the battery, first disconnect the negative (-) terminal of the cable from the ground.
When installing, install the positive (+) terminal first.
- If a tool touches the cable connecting the positive terminal and the chassis, there is danger that it will cause sparks. Do not carry tools in your breast pocket.
- Defective contact caused by loose battery terminals can generate sparks and lead to an explosion.
Tighten the battery terminals securely.

When removing, disconnect the cable from the ground terminal first.

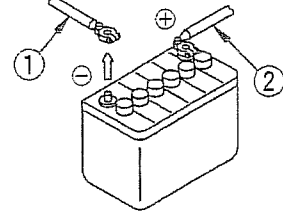

When installing, install the positive (+) terminal first.

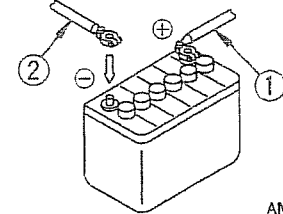

AM087770

10.1 PRECAUTIONS WHEN HANDLING BATTERY

- Always be careful not to let the battery become discharged.
Do not wait for the battery to become discharged before recharging it; measure the specific gravity of the battery electrolyte beforehand and charge the battery if necessary.
Always keeping the battery in good condition will extend the life of the battery.
- When operating the machine in high temperatures, check the level of the battery electrolyte at shorter intervals than specified for periodic inspection and maintenance.
- When working in low temperatures, the capacity of the battery will drop considerably, so maintain the battery charge as close as possible to 100%, and insulate it against cold temperatures so that the machine can be started easily the next morning.
When adding distilled water, to prevent the electrolyte from freezing, always add the distilled water immediately before starting operations on the following morning.

10.2 REMOVAL AND INSTALLATION OF BATTERY

The battery is installed in front of the fuel tank on the front right side of the machine.

[1] REMOVAL

1. Open the inspection cover. For details, see "2.18 BATTERY INSPECTION COVER".
2. Remove locknuts (1) (left and right x 2), then remove plate (2).
3. Disconnect the battery cable from negative (-) terminal (4) for the ground, then disconnect at positive (+) terminal end (5) and cable (6) connecting the batteries.
4. Remove 2 batteries (3).

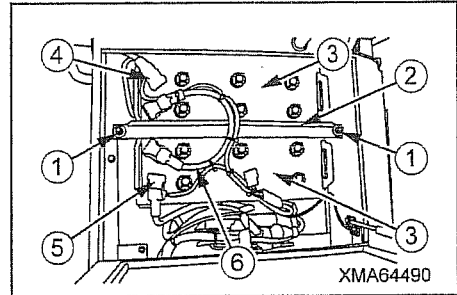

[2] INSTALLATION

Install the batteries in the reverse order to removal.

- ★When connecting the battery cables, always install the negative (-) terminal at the ground end last.

10.3 PRECAUTIONS WHEN CHARGING BATTERY

If the battery becomes discharged or the battery charge is low, charge the battery.

To charge the battery when it is still mounted on the machine, do as follows.

⚠ WARNING

It is dangerous if the temperature of the battery electrolyte exceeds 45°C during charging, so stop charging and wait for the temperature to go down.

- Disconnect the wiring from the battery terminals before charging.
There is danger of abnormal voltage being applied to the alternator and damaging it.
When disconnecting the wiring, always disconnect the negative (-) terminal wiring first; and when connecting the wiring, always connect the negative (-) terminal wiring last.
- During charging, remove all the plugs from the battery cells to allow any gas to escape.
- When the charging is completed, stop the charging immediately.
If the battery is overcharged, overheating of the battery will cause damage to the battery.

★Reference: Measure the specific gravity and calculate the rate of charge from the following conversion table.

Rated of charge (%)	Temp. of battery electrolyte [deg C (deg F)]			
	20 (68)	0 (32)	-10 (14)	-20 (-4)
100	1.28	1.29	1.30	1.31
90	1.26	1.27	1.28	1.29
80	1.24	1.25	1.26	1.27
75	1.23	1.24	1.25	1.26

10.4 STARTING ENGINE WITH BOOSTER CABLE

If the battery is discharged and booster cables are used to start the engine, do as follows

⚠ DANGER

- Be careful not to let the normal machine and problem machine contact each other.
- When connecting the cables, never let the positive (+) and negative (-) terminals contact each other.
- Make sure that there is no mistake in the booster cable connection. When the final connection is made to the negative (-) terminal, sparks will be generated, so do not connect to the negative (-) terminal of the battery on the problem machine. Connect to the engine block.
- When starting the engine with a booster cable, always wear safety glasses.

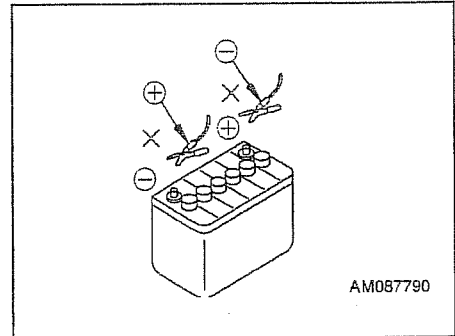

NOTICE

- The size of the booster cable and clip should be suitable for the battery capacity. Check that they are not corroded or damaged.
- The battery on the normal machine must be the same capacity as that on the problem machine.

[1] CONNECTING THE BOOSTER CABLES

★ The numbers in the diagram on the right show the order for connecting the cables.

1. Make sure that the starting switches of the normal machine and problem machine are both at the OFF position.
2. Connect the clips at the ends of booster cable A to the positive (+) terminal of the problem machine and the normal machine.
3. Connect one clip of booster cable B to the negative (-) terminal of the normal machine.
4. Connect the other clip of booster cable B to the engine block of the problem machine.
5. Start the problem machine.

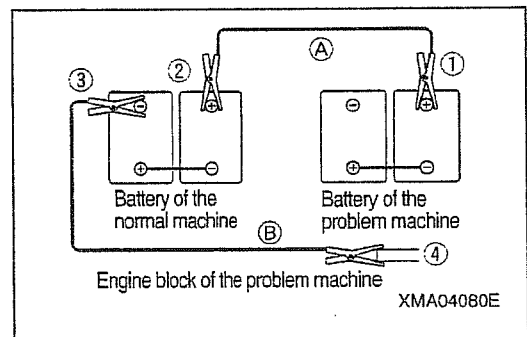

[2] DISCONNECTING THE BOOSTER CABLE

★ The numbers in the diagram on the right show the order for disconnecting the cables.

When the engine on the problem machine starts, remove the cables in the reverse order to connecting.

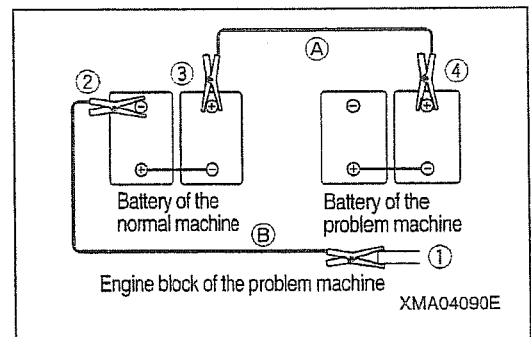

11. TROUBLESHOOTING

If it is felt that there is any abnormality, investigate the cause immediately and take the necessary action to prevent any serious failure.

If the cause is unknown, please contact your distributor for repairs.

When contacting your distributor, please give the machine serial number and engine number.

11.1 PROBLEMS WITH ENGINE RELATED PARTS

Problem	Main causes	Remedy
Starting motor does not turn when starting switch is turned to START	<ul style="list-style-type: none"> • Insufficient battery charge • Defective wiring • Failure in starting motor, relay 	<ul style="list-style-type: none"> • Charge • Check, repair • Contact your distributor
Starting motor turns, but cranks engine slowly	<ul style="list-style-type: none"> • Insufficient battery charge • Defective ground connection wiring • Viscosity of engine oil is too high 	<ul style="list-style-type: none"> • Charge • Check, repair • Change to proper viscosity
Starting motor turns, but engine does not start	<ul style="list-style-type: none"> • Lack of fuel • Air in fuel line • Failure in fuel injection pump • Failure in engine 	<ul style="list-style-type: none"> • Check, add fuel • Bleed air • Contact your distributor • Contact your distributor
After warming-up operation, [Engine oil pressure lamp] on instrument panel stays lighted up even when engine speed is raised (Engine oil pressure does not rise)	<ul style="list-style-type: none"> • Lack of engine oil • Clogged engine oil filter • Failure in engine parts 	<ul style="list-style-type: none"> • Check, add oil • Replace new parts • Contact your distributor
Engine is overheated	<ul style="list-style-type: none"> • Lack of coolant • Leakage of oil from coolant system • Loose fan belt • Clogged radiator fin • Defective thermostat • Overloading, operation under excessive load 	<ul style="list-style-type: none"> • Check, add water • Check, repair or contact your distributor • Check, adjust, or replace new belt • Check, clean • Replace new parts • Reduce to below max. payload
Engine exhaust color is white	<ul style="list-style-type: none"> • Engine oil level is too high • Improper fuel 	<ul style="list-style-type: none"> • Adjust to correct amount • Change to specified fuel
Engine exhaust color is too black	<ul style="list-style-type: none"> • Clogged air cleaner • Improper fuel • Failure in engine 	<ul style="list-style-type: none"> • Check, clean • Change to specified fuel • Contact your distributor
Engine does not run smoothly	<ul style="list-style-type: none"> • Air in fuel line • Fuel filter clogged with dirt, water in fuel filter • Leakage of fuel from fuel system • Failure in engine 	<ul style="list-style-type: none"> • Bleed air • Check, replace new parts, or repair • Check, repair • Contact your distributor
Engine stops when set to low speed	<ul style="list-style-type: none"> • Failure in engine 	<ul style="list-style-type: none"> • Contact your distributor
Engine suddenly stops during operation	<ul style="list-style-type: none"> • Lack of fuel • Lack of engine oil • Failure in engine 	<ul style="list-style-type: none"> • Check, add fuel • Check, add oil • Contact your distributor

11.2 PROBLEMS WITH CHASSIS RELATED PARTS

Problem	Main causes	Remedy
Machine does not move	<ul style="list-style-type: none"> • Parking brake still applied • Leakage of oil from hydraulic system • Travel lever cable disconnected • Failure in hydraulic equipment 	<ul style="list-style-type: none"> • Release parking brake, or check brake piping • Check, repair • Check, repair • Contact your distributor
Warning lamps of monitor display flashes and warning buzzer sounds (HST oil pressure is lowered)	<ul style="list-style-type: none"> • Clogged hydraulic line filter • Clogged strainer inside hydraulic tank • Defective wiring • Failure in hydraulic equipment 	<ul style="list-style-type: none"> • Check, clean • Check, clean • Check, repair • Contact your distributor
Abnormal noise generated from around pump	<ul style="list-style-type: none"> • Clogged strainer inside hydraulic tank • Leakage of oil from hydraulic system • Failure in hydraulic equipment 	<ul style="list-style-type: none"> • Check, clean, or replace new parts • Check, repair • Contact your distributor
Warning lamps of monitor display flashes and warning buzzer sounds (Hydraulic oil temperature rises too high)	<ul style="list-style-type: none"> • Lack of oil inside hydraulic tank • Loose fan belt • Clogged oil cooler fins • Leakage of oil from hydraulic system • Operation under excessive load 	<ul style="list-style-type: none"> • Check, add oil • Check, adjust or replace • Check, clean • Check, repair • Operate within max. payload
Rubber crawler comes off	<ul style="list-style-type: none"> • Rubber crawler tension too loose 	<ul style="list-style-type: none"> • Check, adjust
Abnormal wear of sprocket	<ul style="list-style-type: none"> • Rubber crawler tension too tight 	<ul style="list-style-type: none"> • Check, adjust

11.3 PROBLEMS WITH ELECTRIC RELATED PARTS

Problem	Main causes	Remedy
Head lamp is not bright	<ul style="list-style-type: none"> • Battery charge is too low • Defective alternator 	<ul style="list-style-type: none"> • Charge • Contact your distributor
No lamps light up	<ul style="list-style-type: none"> • Blown fuse • Defective wiring • Defective lamp switch 	<ul style="list-style-type: none"> • Check, replace • Check, repair • Check, replace
Individual head lamps do not light up	<ul style="list-style-type: none"> • Blown bulb • Defective wiring 	<ul style="list-style-type: none"> • Replace • Check, repair
Horn does not sound	<ul style="list-style-type: none"> • Blown fuse • Defective wiring • Defective horn 	<ul style="list-style-type: none"> • Check, replace • Check, repair • Check, replace
Left, right turn signal lamps do not flash	<ul style="list-style-type: none"> • Blown fuse • Defective wiring • Defective flasher relay • Defective flasher switch 	<ul style="list-style-type: none"> • Check, replace • Check, repair • Check, replace • Check, replace
Parking brake buzzer does not sound	<ul style="list-style-type: none"> • Blown fuse • Defective wiring • Defective buzzer • Defective parking brake switch 	<ul style="list-style-type: none"> • Check, replace • Check, repair • Check, replace • Check, replace
Backup buzzer does not sound	<ul style="list-style-type: none"> • Blown fuse • Defective wiring • Defective buzzer • Defective backup switch 	<ul style="list-style-type: none"> • Check, replace • Check, repair • Check, replace • Check, adjust or replace
Slope alarm buzzer does not sound	<ul style="list-style-type: none"> • Blown fuse • Defective wiring • Defective buzzer • Defective slope alarm unit 	<ul style="list-style-type: none"> • Check, replace • Check, replace • Contact your distributor • Contact your distributor

MAINTENANCE

1. Basic outline of maintenance	3-2
2. Precautions for maintenance	3-4
3. Use of fuel and lubricants according to ambient temperature	3-6
4. Tools and tightening torques	3-8
5. Periodic replacement of critical parts	3-10
6. Maintenance schedule chart	3-12
7. Service procedure	3-14

1. BASIC OUTLINE OF MAINTENANCE

[1] OIL

- Oil is used under extremely heavy-duty conditions (high temperature, high pressure) in the engine, hydraulic pump, motor, and work equipment. Therefore, it deteriorates as time passes.

Always use the grade of oil and the oil which matches the ambient temperature listed in this operation manual.

Even if the oil is not dirty, always change it at the specified interval.

- When adding oil, do not mix oils of different grades or brands.
- Always add oil to the specified oil level. Too much oil and too little oil are both the cause of problems.
- When changing the oil, always replace the related oil filter at the same time.
- Always be careful when handling oil to prevent water, dirt, or other impurities from getting into the oil.

A large proportion of problems with the machine are caused by impurities getting into the oil, so be extremely careful not to let impurities get into the oil: always store the oil indoors and carry out oil-filling operations in a dust-free environment.

- If the oil is a milky white, there is probably water or air in the circuit. In such cases, please contact your distributor.

[2] FUEL

- Do not use any fuel except diesel oil.

- Always use the fuel specified for the ambient temperature listed in this operation manual.

- The fuel pump is a precision instrument, so if fuel containing water or dirt is used, the fuel pump will stop working. Be extremely careful not to let impurities get into the fuel: always store the fuel indoors and carry out refueling operations in a dust-free environment.

- If fuel is stored in drum cans, store the drum cans on their sides so that the ports in the drum cans are in a straight line to the side. This action will prevent damp air from being sucked in.

- To prevent moisture in the air from getting into the fuel tank, always fill the tank after the completion of each day's work.

- If the machine runs out of fuel, or when the fuel filter has been replaced, it is necessary to bleed the air the circuit.

Always read the separate operation manual for the engine when carrying out this operation.

[3] COOLANT

- Do not use river water, well water, or water from simple water lines as the coolant.

Such kinds of water contain many impurities, such as calcium and dirt, so scale will collect inside the engine and radiator. This will cause improper heat exchange, and will lead to overheating.

- If the engine overheats, allow the engine to cool down, then add coolant.

- When using antifreeze, always follow the precautions given in the operation manual.

[4] GREASE

- Grease is used at the connecting points of the dump body or travel lever linkage to prevent gouging or noise.

- The grease nipples not listed in this manual are nipples used for overhaul, so there is no need to add grease to them. However, if any gouging or noise occurs during use, add grease.

- When adding grease, pump in grease until the old grease is completely forced out, then wipe off all the old grease. Be particularly careful to wipe off the grease at points where mud and dirt may stick and cause wear of the rotating parts.

[5] FILTERS

- Filters are used to prevent trouble caused when impurities in the oil, fuel, or air enter important equipment. When the replacement interval listed in this manual is reached, always replace or clean the filters.
However, when using this machine under heavy-duty conditions, replace the filters before the specified replacement interval has passed.
- Do not wash and reuse oil filters or fuel filters. Always replace them with new parts.
- When replacing the oil filter, check the old filter for any metal particles or pieces of rubber from the hoses.
If any rubber or metal is found, please contact your distributor. This action is important to prevent any failure before it occurs.
- When using new filters, do not remove the wrapping until immediately before using them.

[6] ELECTRICAL COMPONENTS

- It is extremely dangerous if electrical components become wet or the film covering them is broken. This may lead to electrical leakage and may cause misoperation of the machine. When washing the machine, take care not to get water onto electrical components.
- Never remove any electrical components from the machine or disassemble them.
- Always contact your distributor before installing additional electrical equipment to your machine.
- After the machine has been used near the sea or after it has been used for spreading fertilizer, wipe the electrical components carefully with a dry cloth to prevent corrosion.

[7] HYDRAULIC SYSTEM

- The hydraulic equipment is at high temperature and high pressure during operations and immediately after operations have been completed.
When carrying out inspection and maintenance of the hydraulic equipment, always do as follows.
 - (1) Stop the machine on level ground, and lower the work equipment to the ground so that there is no pressure in the hydraulic cylinder circuit.
 - (2) Always stop the engine.
 - (3) Loosen the hydraulic tank cap slowly, then remove it.
 - (4) Always wait for the temperature to go down before starting maintenance. Even when the temperature goes down, the circuits are still under internal pressure, so when removing plugs or hoses, do not stand directly in front of them, and loosen the connections slowly before removing.
- If high-pressure hoses, connections, or hydraulic equipment have been removed, always replace the O-ring.
- When replacing or cleaning the hydraulic line filter or strainer, or when replacing or repairing the hydraulic equipment or hoses, always bleed the air from the circuit after completion of the operation.

2. PRECAUTIONS FOR MAINTENANCE

WARNING

- Before carrying out inspection and maintenance, always read "2. PRECAUTIONS FOR INSPECTION AND MAINTENANCE in the SAFETY" volume and make sure that you understand the safety procedures for operations.
- Do not carry out any operation not listed in this manual for inspection and maintenance. When carrying out inspection and maintenance of the engine, always read the separate engine operation manual and make sure that you understand it.

[1] CHECK HOURMETER

- Read the hourmeter every day to check if the required interval has been reached for any maintenance item.

[2] USE GENUINE PARTS

- When replacing parts, always use the genuine parts specified in the parts list.

[3] PRECAUTIONS WHEN ADDING OR CHANGING OIL OR GREASE

- When adding or changing fuel, oil, or grease, always use the type specified by Morooka. Be sure to use the viscosity specified for the ambient temperature.
- Never mix types of oil or brands of oil from different makers.
- The oil used when the machine is shipped from the factory is as shown in the table below.

Item	Type	Brand
Engine oil pan	CF class DH-1 10W-30	-
Hydraulic tank	Hydraulic oil ISO VG46	Idemitsu Kosan Super Hydro X 46
Travel motor reduction gear case	SAE90 GL-5	Shin Nihon Sekiyu Gear Lube SP 90

[4] PRECAUTIONS WHEN WASHING OR CLEANING MACHINE

1. Wash or clean the machine to make it easier to locate problem points. In particular, wash the oil filler, level gauge, and greasing plugs to prevent dirt or mud from entering when adding oil or grease.
2. Cover electrical parts, such as the starting motor or alternator, with a sheet to prevent water from getting on them.
3. Do not carry out high-pressure washing for the radiator or oil cooler parts.

[5] BE CAREFUL OF OIL AND COOLANT TEMPERATURE

1. It is dangerous to drain the oil or coolant or replace the filters immediately after stopping the engine. Wait for the machine to cool down before carrying out such operations.
2. When draining the oil, warm up the oil to a suitable temperature (approx. 20 – 40 deg C) before carrying out the operation.

[6] PRECAUTIONS WHEN CHECKING OIL LEVEL, ADDING OIL

1. When checking the oil level or adding oil, choose a place where there is no dust to prevent dirt from entering the oil line.
2. Use clean oil and grease. Use a clean container to prevent dirt from getting in.
3. If there is a strainer fitted to the oil filler port, do not remove the strainer when adding oil.
4. Check that the lubricating oil is at the correct level. The oil level should not be too high or too low.

[7] CHECKING DRAINED OIL, FILTER

- When the oil has been changed or the filter replaced, always check the drained oil and removed filter to check for metal particles or other foreign materials.

[8] SETTING UP WARNING SIGNS

- When the oil or coolant has been drained, put warning signs (Part No.: 1-41010-1210) in the operator's compartment to prevent anyone from starting the engine by mistake.

[9] PRECAUTIONS WHEN WASHING PARTS

- When washing parts, use a non-flammable washing agent or diesel oil.
When using diesel oil, do not bring lighted cigarettes or cigarette lighters close.

[10] PRECAUTIONS WHEN INSTALLING PARTS

- When O-rings, gaskets, or other seals are used for the mounting surface, clean the mounting surface and always replace the seal with a new part.

[11] PRECAUTIONS WHEN CARRYING OUT INSPECTION AND MAINTENANCE OF A MACHINE AFTER OPERATIONS IN DUSTY AREAS

- Check carefully for clogging of the air cleaner, and clean the air cleaner element more frequently.
- Clean the radiator core, oil cooler core and inter cooler core more frequently to prevent clogging.
- Replace the fuel filter more frequently.
- Clean electrical parts carefully (in particular, the starting motor or alternator) to prevent dust from collecting.

[12] PRECAUTIONS WHEN CARRYING OUT INSPECTION AND MAINTENANCE ON MACHINES BEFORE STARTING OPERATIONS IN SWAMPY AREAS, RAIN, RIVERBEDS, OR SNOW

- Before starting operations, check that the drain plug under the engine and the greasing plugs for the track rollers are securely tightened.
- After completion of operations, wash the machine carefully and check for cracks and damage, and for loose or missing nuts and bolts.

3. USE OF FUEL AND LUBRICANTS ACCORDING TO AMBIENT

TEMPERATURE

3.1 FUEL, COOLANT, AND LUBRICANT TABLE

NOTICE

- The quality of engine oil influences significantly on the engine performance and start ability. Always use the engine oil of CG-4 class or CAT diesel engine oil Cat DEO and of specified viscosity (refer to the table below) according to the ambient temperatures.
- Always use diesel fuel. Never use additives such as anti-freeze and water-removing agents. Otherwise, the fuel injection system may be damaged. Never use kerosene, as it may cause a trouble.

- Select the fuel and oil from the table below according to the ambient temperature.
- The specified capacity is the total amount of oil, including the oil in the piping of the various components.
- The refill capacity is the amount of oil added when changing the oil during inspection and maintenance.
- When starting the engine in an ambient temperature of lower than 0 deg C, always use a grade specified for temperatures below 0 deg C, even if the temperature goes up to 10 deg C during the daytime.
- For the coolant mixture ratio of cooling water, see "Operation 8. Cold Weather Operation" in "[2] Coolant Mixture Ratio in Cooling Water".

RESERVOIR	KIND OF FLUID	AMBIENT TEMPERATURE								CAPACITY	
		-22 -30	-4 -20	14 -10	32 0	50 10	68 20	86 30	104°F 40°C	Specified	Refill
Engine oil pan	Engine oil	SAE15W-40								16.5 ℓ 4.36 US gal 3.63 UK gal	12.5 ℓ 3.30 US gal 2.75 UK gal
		SAE10W-30									
Hydraulic oil tank	Hydraulic oil	ISO VG56								102 ℓ 26.95 US gal 22.44 UK gal	92 ℓ 24.31 US gal 20.24 UK gal
		ISO VG46									
		ISO VG32									
Travel motor reduction gear case(each)	Gear oil	SAE90								3.9 ℓ 1.03 US gal 0.86 UK gal	-
Fuel tank	Diesel fuel	ASTM D975 No.2								156 ℓ 41.22 US gal 34.32 UK gal	-
		ASTM D975 No.1									
Cooling system	Water	Long Life Coolant								21 ℓ 5.55 US gal 4.62 UK gal	-

REMARK

- When fuel sulphur content is less than 0.5 %, change oil in the oil pan every periodic maintenance hours described in this manual.

Change oil according to the following table if fuel sulphur content is above 0.5%.

Fuel sulphur content	Change interval of oil in engine oil pan
0.5 to 1.0%	1/2 of regular interval
Above 1.0%	1/4 of regular interval

- When starting the engine in an atmospheric temperature of lower than 0 deg C, be sure to use engine oil of SAE10W-30 and SAE15W-40, even though an atmospheric temperature goes up to 10 deg C more or less in the day time.
- Use API classification CD as engine oil and if API classification CC, reduce the engine oil change interval to half.
- There is no problem if single grade oil is mixed with multigrade oil (SAE10W-30, 15W-40), but be sure to add single grade oil that matches the temperature in the table.
- We recommend genuine oil which has been specifically formulated and approved for use in engine and hydraulic work equipment applications.

Specified capacity: Total amount of oil including oil for components and oil in piping.

Refill capacity: Amount of oil needed to refill system during normal inspection and maintenance.

ASTM: American Society of Testing and Material

SAE: Society of Automotive Engineers

API: American Petroleum Institute

- Hydraulic oil: Nihon Sekiyu Highland Wide KV46.
 - ★ When changing the hydraulic oil, please contact your distributor.

4. TOOLS AND TIGHTENING TORQUES

4.1 INTRODUCTION OF NECESSARY TOOLS

The following tools are needed when carrying out maintenance.

If the tools are broken or worn, please order new tools from your distributor.

No.	Name of tool	Part No.	Remarks
1	Wrench set	0-9100-00000 0-9100-00709 0-9100-00810 0-9100-01113 0-9100-01214 0-9100-01719 0-9100-02224	Width across flats (S1 x S2) 7mm x 9mm 8mm x 10mm 11mm x 13mm 12mm x 14mm 17mm x 19mm 22mm x 24mm
2	Wrench	0-9105-04600	Width across flats 46mm
3	Screw driver (+)	0-9210-00150	
4	Screw driver (-)	0-9200-00200	

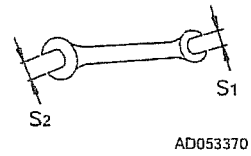

4.2 TORQUE LIST FOR BOLTS AND NUTS

Unless otherwise specified, tighten the metric bolts and nuts to the torque shown in the table below.

The tightening torque is determined by the width across flats (b) of the nut and bolt.

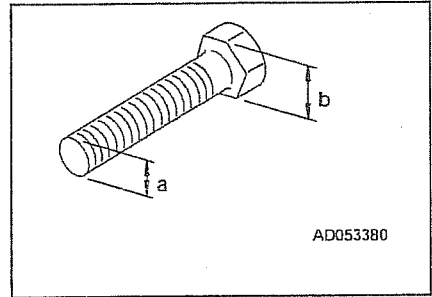

NOTICE

When tightening panels or other parts with tightening fixtures made of plastic, be careful not to use excessive tightening torque. Tightening excessively will damage the plastic parts. Be extremely careful when tightening.

Thread diameter x Width across thread pitch flats (a) (mm x mm)	Width across flats (b) (mm)	Tightening torque (kgf-m) {N-m}	
		Tensile strength 4T	Tensile strength 11T
3x0.5	5.5	0.05 {0.5}	0.2 {1.8}
4x0.7	7	0.1 {1.0}	0.4 {4.1}
5x0.8	8	0.2 {2.2}	0.8 {8.2}
6x1.0	10	0.4 {3.6}	1.4 {14.0}
8x1.25	13	0.9 {8.9}	3.5 {34.0}
10x1.5	17	1.8 {17.7}	6.9 {67.4}
12x1.75	19	3.2 {30.9}	12.0 {117}
14x2.0	22	5.0 {49.1}	19.1 {187}
16x2.0	24	7.8 {76.7}	29.7 {291}
18x2.5	27	10.7 {105}	40.9 {401}
20x2.5	30	15.3 {149}	58.1 {570}
22x2.5	32	20.8 {203}	79.0 {775}
24x3.0	36	26.4 {258}	100 {983}
27x3.0	41	38.6 {378}	147 {1440}
30x3.5	46	52.4 {513}	199 {1955}
33x3.5	50	71.3 {699}	271 {2660}
36x4.0	55	91.6 {898}	348 {3416}
39x4.0	60	119 {1162}	451 {4421}

5. PERIODIC REPLACEMENT OF CRITICAL PARTS

5.1 PERIODIC REPLACEMENT INTERVAL (EVERY 2 YEARS)

In order to further increase the safety of the machine Morooka recommends periodic inspection and replacement of critical parts (hydraulic hoses, fuel hoses, etc.) which are related to causes of fire and to efficiency in the raising and lowering of the dump body and traveling and stopping functions of the machine.

With these parts, the material changes as time passes, and they easily wear or deteriorate. However, it is difficult to judge the condition of the parts simply by periodic maintenance, so they should always be replaced after a fixed time has passed, regardless of their condition. Always replace them with new genuine parts to ensure that the machine always maintains its function completely.

5.2 PERIODIC INSPECTION

WARNING

- Check the hydraulic hoses and fuel hoses carefully to check for cracks, deterioration, or other damage, and to check that there is no leakage from the connections.
When carrying out checks before starting, always check the ground under the machine to check for traces of oil leakage.
- When replacing the hydraulic hoses or fuel hoses, always order genuine parts. Never use any imitation or substitute parts.
- When any hydraulic hose is replaced, always replace the O-rings at the same time. Failure to do this will cause oil leakage.

If the monthly inspection or checks before starting show any abnormality, such as leakage of oil or deformation and cracking, tighten the parts immediately or replace them with new genuine parts.

When doing this, check the hose clamps at the same time, and replace them if they are deformed or cracked.

Check and repair any hydraulic hoses, even if they are not listed as critical parts.

The table below shows the checks to be carried out during periodic maintenance.

Periodic maintenance interval	Inspection items
Checks before starting	<ul style="list-style-type: none">• Leakage of oil from caulked portions, connections of fuel hoses, hydraulic hoses
Monthly inspection	<ul style="list-style-type: none">• Leakage of oil from caulked portions, connections of fuel hoses, hydraulic hoses• Damage to fuel hoses, hydraulic hoses (cracks, wear, gouging, swelling, crushing)• Interference with other parts
Every 2 years inspection	<ul style="list-style-type: none">• Replacement of critical parts• Leakage of oil from caulked portions, connections of fuel hoses, hydraulic hoses• Damage to fuel hoses, hydraulic hoses (cracks, wear, gouging, swelling, crushing)• Interference with other parts

5.3 SPECIFIED PERIODIC REPLACEMENT PARTS

⚠ CAUTION

- The list of periodic replacement parts specified by Morooka does not include the fuel hoses on the engine. Refer to the separate engine parts list (parts book) and carry out replacement in the same way as for the periodic replacement parts specified by Morooka.
- For details of the part numbers for periodic replacement parts specified by Morooka, see the parts list (parts book), and contact your distributor to place orders.

As the periodic replacement parts, the parts shown in the table below should be used.

For details of the parts, see the parts list (parts book).

No.	No. Periodic replacement parts	Q'ty	Replacement interval
1	Fuel hose (fuel pump to fuel injection pump)	1	Replace every 2 years
2	Fuel hose (fuel injection pump to fuel tank)	1	
3	Hydraulic hose (main pump to/from travel motor)	4	
4	Hydraulic hose (gear pump to main control valve)	1	
5	Hydraulic hose (main control valve to dump cylinder)	2	
6	Hydraulic hose (Between left and right dump cylinders)	2	
7	Seat belt	1	Replace every 3 years

6. MAINTENANCE SCHEDULE CHART

Service item	Page
7.2 INITIAL 100 HOURS SERVICE ★This is only after the first 100 hours for new machines	3-14
[1] Change engine lubricating oil, replace engine oil filter	3-30
[2] Replace hydraulic line filter	3-33
[3] Change oil in hydraulic tank	3-34
7.3 INITIAL 500 HOURS SERVICE ★This is only after the first 500 hours for new machines	3-14
[1] Change oil inside travel motor reduction gear case	3-35
7.4 WHEN REQUIRED ★If necessary, carry out these checks every day.	3-15
[1] Check, adjust rubber crawler tension	3-15
[2] Check rubber crawler for damage, wear	3-16
[3] Clean, replace air cleaner	3-17
[4] Clean inside of cooling system and change coolant	3-19
[5] Check, clean radiator fins, oil cooler fins, inter cooler fins, Air conditioner condensor fins	3-21
[6] Check window washer fluid level, add fluid	3-21
[7] Check refrigerant (Gas) volume	3-22
[8] Clean, replace filter of air conditioner	3-23
[9] Fuel system prime	3-24
7.5 CHECK BEFORE STARTING ★Always carry out the following checks before starting the engine.	3-25
[1] Check coolant level, add water	3-25
[2] Check fuel level, add fuel	3-25
[3] Check engine lubricating oil level, add oil	3-26
[4] Check oil level in hydraulic tank, add oil	3-26
[5] Check dust indicator	3-27
[6] Drain water, sediment from fuel/water separator	3-27
[7] Check, adjust air compressor belt tension	3-28
[8] Check electric wiring	3-29
[9] Check operation of switches, lamps, gauges	3-29
[10] Check operation of horn, alarm buzzer	3-29
7.6 EVERY 50 HOURS SERVICE	3-30
[1] Drain water, sediment from fuel tank	3-30
[2] Check fan belt for wear and cracking	3-30
7.7 EVERY 100 HOURS SERVICE	3-30
[1] Check battery electrolyte level, add distilled water	3-30
7.8 EVERY 250 HOURS SERVICE	3-31
[1] Change engine lubricating oil, replace engine oil filter	3-31
[2] Grease all parts of dump cylinder	3-32
[3] Grease dump body rear side flap opening rod	3-32
[4] Grease dump body hinge pin	3-32
[5] Grease dump body rear side flap opening lever	3-32
[6] Grease track roller pivot shaft	3-33

Service item	Page
7.9 EVERY 500 HOURS SERVICE	3-34
[1] Replace fuel/water separator	3-34
[2] Replace fuel filter	3-35
[3] Replace hydraulic line filter	3-35
[4] Change oil in hydraulic tank	3-36
7.10 EVERY 1500 HOURS SERVICE	3-37
Change oil inside travel motor reduction gear case	3-37

7. SERVICE PROCEDURE

7.1 OUTLINE OF INSPECTION AND MAINTENANCE PROCEDURES

This section explains the methods for inspection and maintenance operations listed in "6. MAINTENANCE SCHEDULE CHART".

Always observe the precautions related to safety for each item, and carry out the operation safely.

If the operation is difficult, do not try to carry it out; please contact your distributor.

- The operations in this section require the following parts to be removed or opened, and then installed or closed.

For details of the procedure, see the following sections.

(1) Engine inspection cover: See "OPERATION, 2.18 ENGINE INSPECTION COVER".

(2) Battery inspection cover: See "OPERATION, 2.19 BATTERY INSPECTION COVER".

(3) Front grill: See "OPERATION, 2.20 FRONT GRILL".

(4) Undercover: See "OPERATION, 2.21 UNDERCOVER".

7.2 INITIAL 100 HOURS SERVICE

Carry out the following maintenance after the initial 100 hours breaking-in operation for new machines.

[1] CHANGE ENGINE LUBRICATING OIL, REPLACE ENGINE OIL FILTER

For details of the method of maintenance, see EVERY 250 HOURS SERVICE.

[2] REPLACE HYDRAULIC LINE FILTER

For details of the method of maintenance, see EVERY 500 HOURS SERVICE.

[3] CHANGE OIL IN HYDRAULIC TANK

For details of the method of maintenance, see EVERY 500 HOURS SERVICE.

7.3 INITIAL 500 HOURS SERVICE

Carry out the following maintenance after the initial 500 hours breaking-in operation for new machines.

[1] CHANGE OIL INSIDE TRAVEL MOTOR REDUCTION GEAR CASE

For details of the method of maintenance, see EVERY 1500 HOURS SERVICE.

7.4 WHEN REQUIRED

[1] CHECK, ADJUST RUBBER CRAWLER TENSION

⚠ WARNING

The tension adjuster for the rubber crawler is charged with grease. The grease is kept under high pressure by the recoil spring inside the tension adjuster.

Always follow the precautions given below. Failure to follow these precautions may cause the valve to fly out, resulting in serious injury or accident.

- Never loosen the tension adjustment valve more than one turn. There is danger that the valve may fly out.
- When adjusting the tension, never stand directly in front of the valve. It is dangerous.

• CHECKING TENSION

1. Drive the machine a short distance forward and backward, then stop the engine.
2. Measure distance **A** from the rear end of the track frame to the center of the idler, and check that it is within the following range.
 - ★ Dimension **A**: 375 ± 5 mm
 - ★ If the result of the measurement shows that dimension **A** is greater than the specified range, adjust the rubber crawler tension. For details, see "ADJUSTING TENSION".

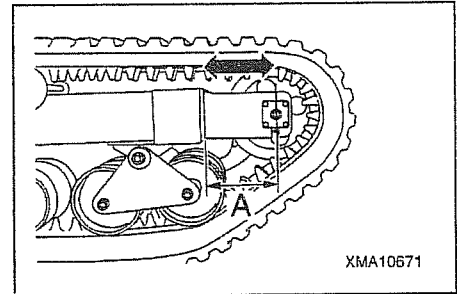

• ADJUSTING WHEN TENSION IS LOOSE (When measurement is below range for dimension A)

- ★ Before adjusting, prepare a grease pump.
1. Remove 2 bolts, then remove grease valve cover (1).

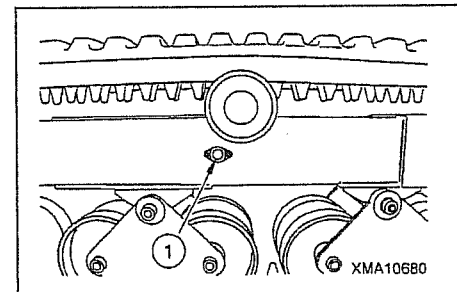

2. Using the grease pump, pump in grease through valve (2) until dimension **A** is within the range given for "CHECKING TENSION".
 - ★ If dimension **A** does not enter the range above even when grease is pumped in, the rubber crawler must be replaced, or there is probably some abnormality in the tension adjuster, so please contact your distributor.
3. Drive the machine a short distance forward and backward to make the tension uniform, then repeat the steps for "CHECKING TENSION" to measure dimension **A**.
4. Install grease valve cover (1), then tighten the bolts.

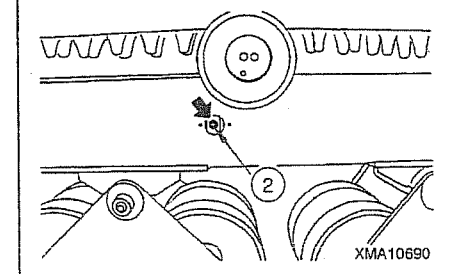

• **ADJUSTING WHEN TENSION IS TIGHT** (when measurement is above range for dimension A)

1. Remove 2 bolts, then remove grease valve cover (1).

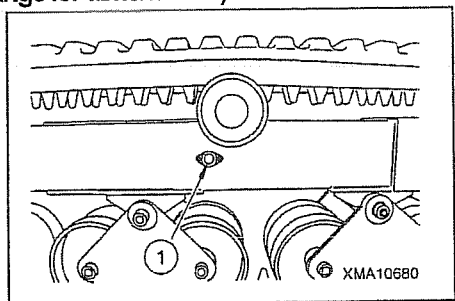

2. Loosen valve (2) until dimension A is within the range given for "CHECKING TENSION".

★ If the grease comes out slowly, push the idler end of the rubber crawler strongly.

Never loosen valve (2) more than 1 turn.

★ If the grease still comes out slowly, start the engine and drive the machine a short distance forward and backward.

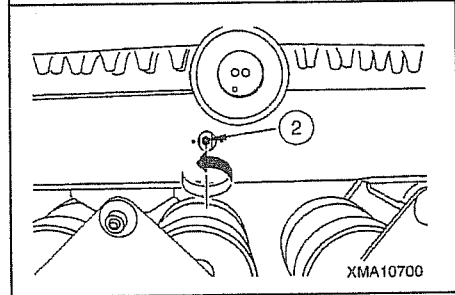

3. Tighten valve (2) securely.

4. Drive the machine a short distance forward and backward to make the tension uniform, then repeat the steps for "CHECKING TENSION" to measure dimension A.

5. Install grease valve cover (1), then tighten the bolts.

[2] CHECK RUBBER CRAWLER FOR DAMAGE, WEAR

⚠ WARNING

If there are any large cracks or damage to the rubber crawler, replace the rubber crawler immediately. There is danger that the rubber crawler may break suddenly without warning during operations.

NOTICE

- When checking the rubber crawler, remove all mud and snow from the crawler before checking.
- Using the rubber crawler when it has exceeded the wear limit will cause slipping and will reduce the drawbar pull. If the rubber crawler is in the following condition, replace it with a new rubber crawler.

• If the height of the lug is less than 1/3 of the standard dimension, replace the rubber crawler.

★ Standard height: 50 mm

★ Wear limit: 16 mm

• If there are cracks or deep cuts and the wire in the core of the rubber crawler can be seen, replace the rubber crawler.

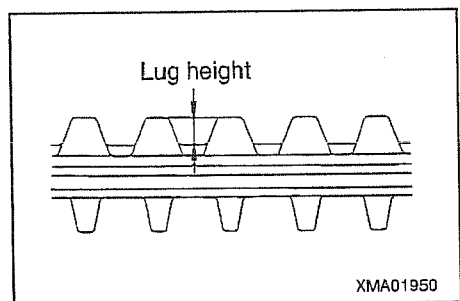

[3] CLEAN, REPLACE AIR CLEANER

WARNING

- Never clean, or replace the air cleaner when the engine is running.
- When using compressed air to clean the element, there is danger that dirt and dust may fly and get into eyes. Always wear safety glasses.

NOTICE

- When cleaning the outer element, do not hit it or knock it against other objects.
- Do not use the outer element if the folds or seal are damaged.
- Replace the outer element with a new part if it has been cleaned three or four times, or if it has been used for one year. When replacing the outer element, replace the inner element at the same time.
- After cleaning the outer element, if the engine exhaust gas color is black or there is lack of power, replace the outer element. When replacing the outer element, replace the inner element at the same time.
- Never clean the inner element and use it again. Always replace it with a new element.

• CHECK AIR CLEANER

If dust indicator (1) inside the air cleaner is red, clean the air cleaner element.

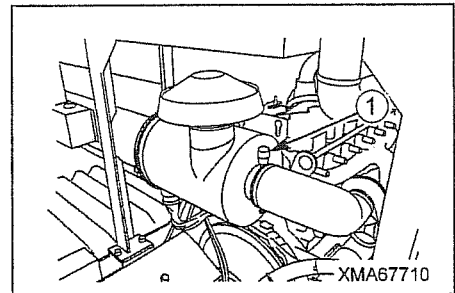

• METHOD OF CLEANING OUTER ELEMENT

1. Remove 3 catchers (3) at the air cleaner cover, then remove air cleaner cover (2).

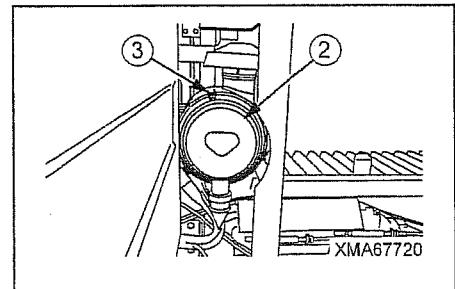

2. Take out the outer element (4).

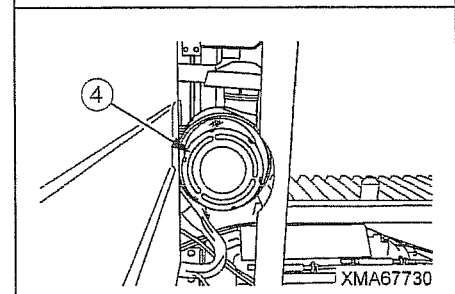

3. Blow with dry compressed air (max. 0.68 MPa [7 kgf/cm²]) along the folds from the inside of element.

Next, blow along the folds from the outside of the element, then blow from the inside of the element again.

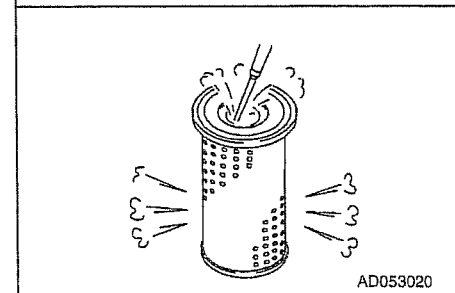

4. After cleaning, use a light bulb from inside the element to check if there are any small holes or thin places in the element. Replace the element if such places are found.

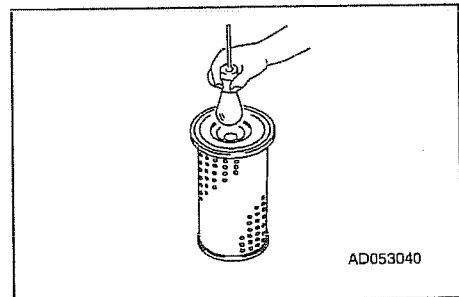

5. After cleaning the outer element (4), insert the outer element (4) to the body.
6. Remove the valve (5) from the air cleaner cover (2), then clean the inside of the valve and cover.
7. After cleaning the valve (5) and air cleaner cover (2), install the valve (5) to air cleaner cover (2).

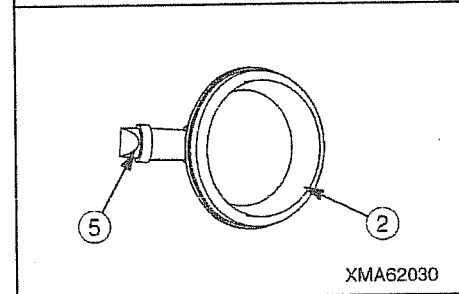

8. Fit the air cleaner cover (2) to the body, then secure with catcher (3).
- ★With the air cleaner cover (2), install with the stamped "TOP" mark (6) upward.

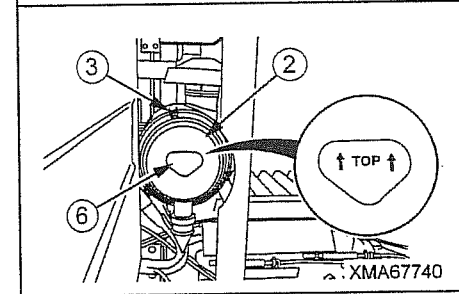

• METHOD OF REPLACING OUTER ELEMENT

Remove the outer element and replace it with a new element.

For details of the procedure, see METHOD OF CLEANING OUTER ELEMENT. When replacing the outer element, replace the inner element at the same time. For details, see METHOD OF REPLACING INNER ELEMENT.

• METHOD OF REPLACING INNER ELEMENT

1. Remove the outer element.

For details of the procedure, see METHOD OF CLEANING OUTER ELEMENT.

2. Take the out inner element (7).
3. Cover the air connector end (air outlet) with a clean cloth or cloth tape.
4. Clean the inside of the body, then remove the cover fitted in Step 3.
5. Insert the new inner element (7) in the body.
6. Install the outer element (4).

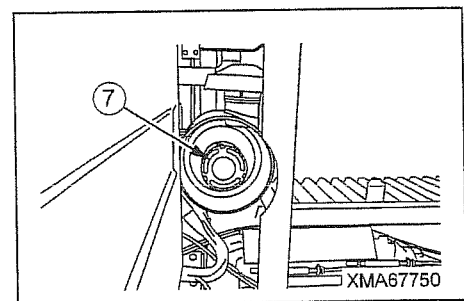

For details of the procedure, see METHOD OF CLEANING OUTER ELEMENT.

[4] CLEAN INSIDE OF COOLING SYSTEM AND CHANGE COOLANT

⚠ WARNING

- Immediately after the engine is stopped, the coolant is at high temperature, so there is danger of burns if you drain the coolant immediately.
Wait for the engine to cool down before draining the coolant.
- Do not suddenly remove the cap when the radiator water temperature is high. Boiling water will spurt out and cause burns.
Wait for the water temperature to go down before removing the cap. When removing the cap, turn it slowly to fully release the internal pressure, then remove the cap.

NOTICE

- Replace the cooling water (coolant) every year or 2000 running hours whichever comes first.
- For the coolant mixture ratio of cooling water, see "Operation 8. Cold Weather Operation" in "[2] Coolant Mixture Ratio in Cooling Water".

Clean the cooling water circuit as follows.

★ Use tap water for the coolant.

Do not use river water, well water, or untreated water supplies.

1. Stop the machine on level ground and stop the engine.
2. Remove the radiator inspection cover (1).
3. Turn radiator cap (2) slowly to fully release the internal pressure, and remove it.
4. Remove the undercover.
5. Use hex. wrench (6 mm), remove radiator drain plug (3) and drain the water.
★ If there is antifreeze in the coolant, put container to catch the water under of the drain plug.
6. After draining the water, install the drain plug (3), then add tap water through the water filler to fill the radiator.
7. Remove radiator drain plug (3), then start the engine, run at low idling, and run water through the system to flush it for 10 minutes.
★ While running water through the cooling system to flush it, be careful to adjust the water flow so that the radiator is always full.
★ While running water through the cooling system to flush it, be careful that the water supply hose does not slip out of the water filler.

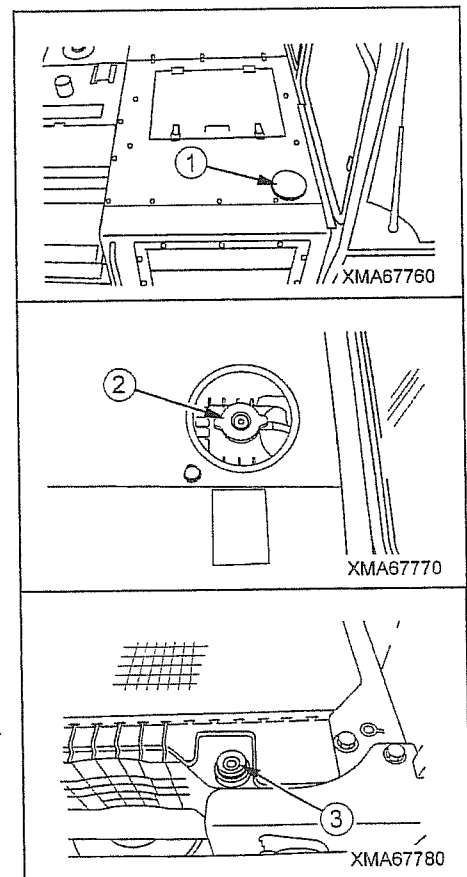

8. After flushing the system, stop the engine, stop the water supply, then drain the water.
9. After draining the water, install the radiator drain plug (3), then add cleaning agent through the water filler.
 - ★For details of the method of cleaning, see the instructions on the cleaning agent
10. After flushing with cleaning agent, remove radiator drain plug (3), drain the water, then start the engine, run at low idling, and flush with water until clean water comes out.
 - ★While running water through the cooling system to flush it, be careful to adjust the water flow so that the radiator is always full.
 - ★While running water through the cooling system to flush it, be careful that the water supply hose does not slip out of the water filler.
11. When clean water comes out, stop the engine, and install the radiator drain plug (3).
12. Add tap water through the water filler to fill the radiator.
13. Start the engine, run for 5 minutes at low idling, then run for a further 5 minutes at high idling to remove the air from the coolant.
 - ★Leave the radiator cap removed when doing this.
14. Stop the engine, leave for approx. 3 minutes, then add tap water to near the top of the water filler, and tighten the radiator cap (2).

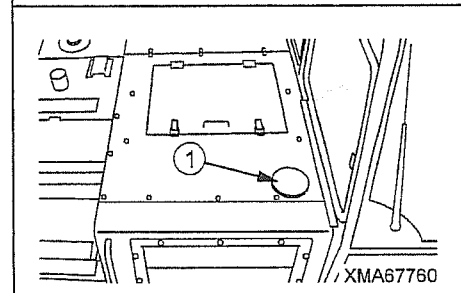
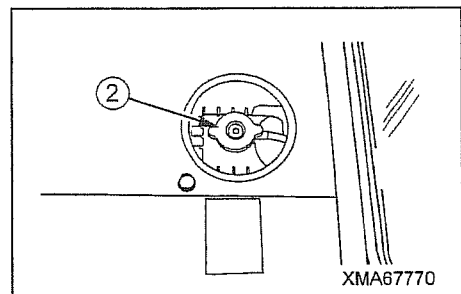

15. Install the radiator inspection cover (1).
16. Install the undercover.

[5] CHECK, CLEAN RADIATOR, OIL COOLER, INTER COOLER, A/C CONDENSOR FINS

⚠ WARNING

- Never inspect or clean the fins when the engine is running. Always stop the engine before starting the operation.
- When using compressed air to clean the fins, there is danger that dirt and dust may fly and get into eyes. Always wear safety glasses.

NOTICE

- When cleaning the fins, use compressed air at a pressure of less than 0.29Mpa {3 kgf/cm²}, and stand away from the fins when directing the compressed air. If the compressed air is blown directly against the radiator or is blown at high pressure, the fins will be damaged and this will cause leakage of water or oil.
- When cleaning the fins, do not use steam or water instead of compressed air. This causes clogging.

1. Remove the front grill.
2. From the front face of the front grill, check intercooler fins (1), radiator fins (2), condenser fins (3), and oil cooler fins (4) to see if there is any mud, dirt, dead leaves, or paper clogging the fins.
 - ★ The oil cooler is installed at the bottom of the condenser.
3. If the result of the inspection shows that the fins are clogged, blow with dry compressed air (0.29 MPa [3 kgf/cm²]) to clean.
4. After cleaning the fins, install the front grill.

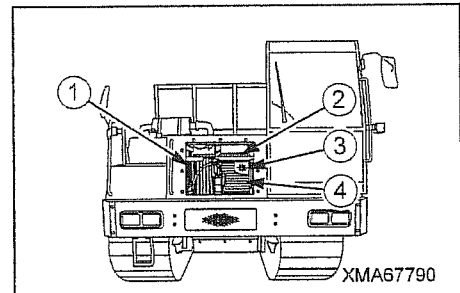

[6] CHECK WINDOW WASHER FLUID LEVEL, ADD FLUID

• CHECKING, FILLING

If the window washer fluid does not come out, remove cap (2), and check the level of the fluid in washer tank (1).

If the level is low, fill with automobile window washer fluid.

- ★ When filling with fluid, be careful not to let dirt get in.
- ★ The washer tank is installed to the outside at the rear of the cab.

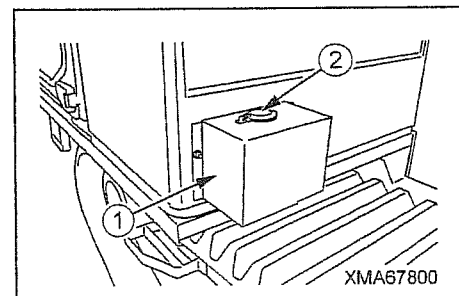

• Mixing RATIO FOR WINDOW WASHER FLUID

Change the mixture ratio of the window washer fluid according to the ambient temperature.

Mix the concentrated window washer fluid with tap water according to the proportions given in the table below, then fill the washer tank.

- ★ There are two types of concentrated window washer fluid: the general type for use at freezing temperatures of -10 deg C, and a cold weather type for use in temperatures down to -30 deg C. Select the type according to the territory and season.

Territory, season	Mixing proportion		Freezing temperature
	Concentrated fluid	Tap water	
Normal	1/3	2/3	-10°C (14°F)
Winter in cold area	1/2	1/2	-20°C (-4°F)
Winter in extremely cold area	Use undiluted washer fluid	None	-30°C (-22°F)

[7] CHECK REFRIGERANT (GAS) VOLUME

⚠ WARNING

- If the refrigerant used in the cooler gets into your eyes or on to your hands, it may cause loss of sight or frost bite. Never loosen or remove any part of the refrigerant circuit.
- Always ask your refrigerant dealer to charge the cooler with refrigerant.

NOTICE

- If the cooler is operated when it has run out of refrigerant or the refrigerant level is low, the compressor will be damaged. Always check the refrigerant level before using the cooler.
- Even in the off-season when the cooler is not being used, run the cooler for 3 to 5 minutes once a month.

- Check the volume of refrigerant in the cooler through the top of the receiver which is charged with gas or through sight gauge (2).

Receiver (1) is mounted on the right side of the condenser inside the front grill.

Remove the front grill to carry out inspection.

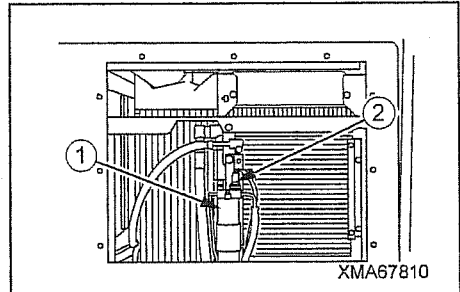

- Check the volume of refrigerant in the cooler as follows.

1. Remove the front grill.
2. Start the engine and run at high idling.
3. Set the control panel inside the operator's compartment to cooling and run at high speed.
4. Look through receiver (1) or sight gauges (2) (inspection window) to check the condition of the gas flowing in the refrigerant circuit.

Compare it with the table below to judge the condition.

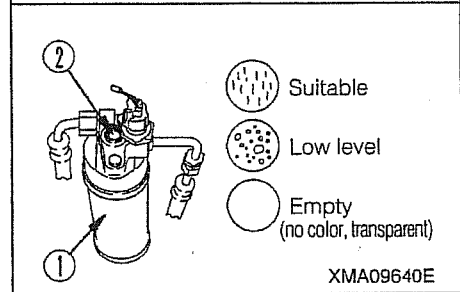

Judgment of refrigerant level	Condition in sight gauge
Suitable	No bubbles in refrigerant flow
Low level	Continuous bubbles in refrigerant flow
Empty	Sight gauge is colorless, transparent

5. Check for oil oozing out from the connection of the piping of the receiver (1).
If there is oil oozing out, gas is leaking.

[8] CLEAN, REPLACE FILTER OF AIR CONDITIONER

NOTICE

Do not use compressed air to clean filters. Doing so may damage the filter, causing dirt and dust to be inhaled through the filter and fail the air conditioner unit.
To clean filters, wash them lightly with water, and dry them in shade.

• REMOVING FILTERS

Remove 6 screws (2), and remove filter (1) at the top of the operator's seat.

★When removing screw (2), use the top end of the screw driver (-) and pull the plug (3) out at the center.

• CLEANING FILTERS

Take the following steps to clean filters with water.

1. Wash the filter with running tap water.
2. Immerse it in water with neutral detergent for approximately five minutes.
3. Wash it again with running tap water.
4. Dry it in shade.

• INSTALLING FILTERS

Set cleaned or new filters to original position, and install 6 screws (2) and then insert plug (3) to screw (2).

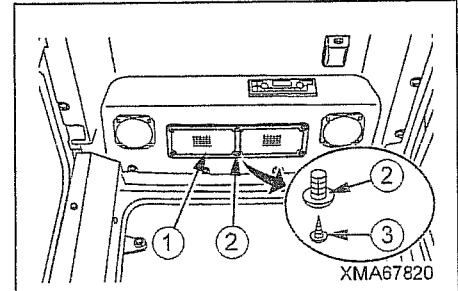

[9] FUEL SYSTEM PRIME

WARNING

Contact with high pressure fuel may cause fluid penetration and burn hazards. High pressure fuel spray may cause a fire hazard. Failure to follow these inspection, maintenance and service instructions may cause personal injury or death.

NOTICE

Do not crank the engine continuously for more than 15 seconds. Allow the starting motor to cool for two minutes before cranking the engine again.

If air enters the fuel system, the air must be purged from the fuel system before the engine can be started. Air can enter the fuel system when the following events occur.

- The fuel tank is empty or the fuel tank has been partially drained.
- The low pressure fuel lines are disconnected.
- A leak exists in the low pressure fuel system.
- The fuel filter has been replaced.

Hand Fuel Priming Pump

★ Fuel/water separator is installed to inside surface of the mainframe right end (main pump right end, forward of hydraulic line filter).

Use the following procedures in order to remove air from the fuel system.

1. Go under the machine and operate the fuel priming pump (1). Count the number of operations of the fuel priming pump.
After 100 depressions of the fuel priming pump stop.
 2. The engine fuel system should now be primed and the engine should now be able to start.
 3. Operate the engine starter and crank the engine.
After the engine has started, operate the engine at low idle for a minimum of five minutes, immediately after air has been removed from the fuel system.
- ★ Operating the engine for this period of time will help ensure that the fuel system is free of air.
- ★ Do not loosen the high pressure fuel line in order to purge air from the fuel system. This procedure is not required.

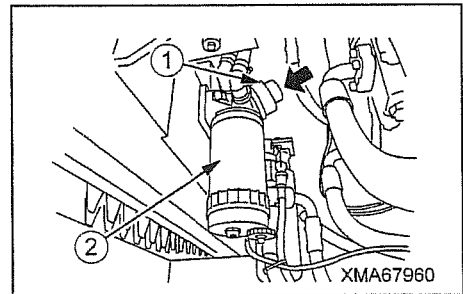

7.5 CHECK BEFORE STARTING

[1] CHECK COOLANT LEVEL, ADD WATER

⚠ WARNING

When checking the coolant level and adding water, always carry out the operation at the reserve tank. Never remove the radiator cap to check.

NOTICE

If the result of the coolant level check shows that more water must be added than usual, there is probably a water leak, so search for the cause and repair the problem immediately.

1. Remove the radiator inspection cover (1).

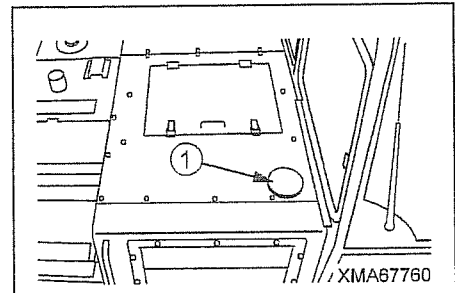

2. Turn the radiator cap (2) slowly to fully release the internal pressure, and remove it.
3. Check the coolant level is close to the bottom of the filler port.
If the coolant level is low, add tap water.
4. After adding water, tighten the radiator cap (2) securely.
5. Install the radiator inspection cover (1).

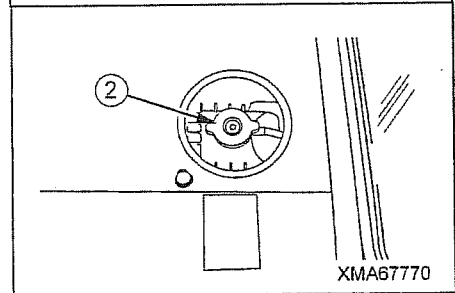

[2] CHECK FUEL LEVEL, ADD FUEL

⚠ DANGER

When adding fuel, never let the fuel overflow from the tank. This will cause fire.

1. Check the fuel level with level gauge (1) at the side face of the fuel tank.
 2. Release the lock on the cap (2) with a key and remove the cap (2) from the fuel tank and add fuel through the fuel filler.
 3. Check the breather hole on the inside of the cap, and if it is clogged, wash it.
 4. After adding fuel, tighten the cap (2) securely and lock up it with a key.
- ★ Always fill the fuel tank after completing the day's operation.

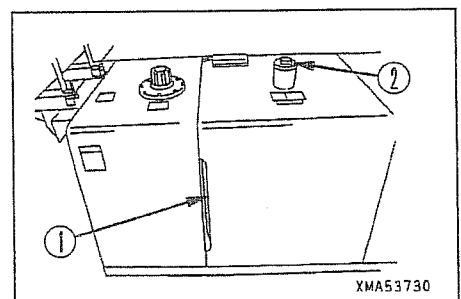

[3] CHECK ENGINE LUBRICATING OIL LEVEL, ADD OIL

• CHECKING OIL LEVEL

1. Open the engine inspection cover.
2. Pull out dipstick (1) at the engine rear left side and wipe the oil off with a cloth.
3. Insert dipstick (1) fully into the gauge guide, then pull it out again.
4. If there is oil on dipstick (1) in the notched area, the oil level is correct.
If the oil does not reach the bottom of the notched area, add engine oil.
5. Close the engine inspection cover.

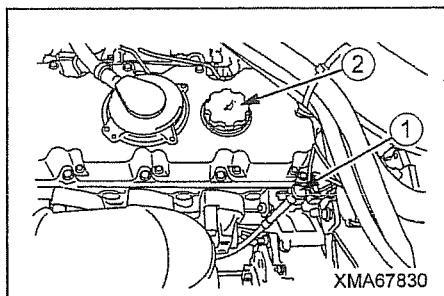

• FILLING WITH OIL

1. Remove cap (2) and add engine oil.
★For details of the engine oil, see "3. USE OF FUEL AND LUBRICANTS ACCORDING TO AMBIENT TEMPERATURE".
★Use a container with an attached hose when filling with oil.
2. Check the oil level again, and if it is within the specified range, tighten cap (2) securely.

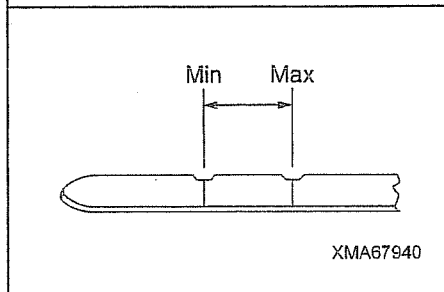

[4] CHECK OIL LEVEL IN HYDRAULIC TANK, ADD OIL

1. Use level gauge (1) at the side face of the hydraulic tank to check the oil level and the condition of dirt in the oil. The oil level should be between the top and bottom red lines on the gauge.
2. If the oil level is low, remove cap (2) of the hydraulic tank and add hydraulic oil through the oil filler.
★For details of the hydraulic oil, see "3. USE OF FUEL AND LUBRICANTS ACCORDING TO AMBIENT TEMPERATURE".
3. Check the breather hole inside the cap and clean it if it is clogged.
4. After adding oil, tighten cap (2) securely.

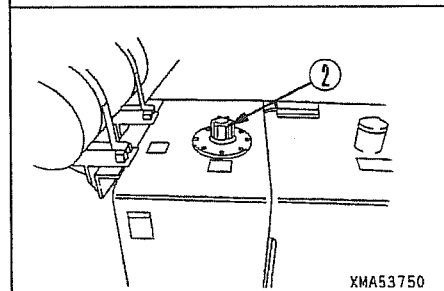
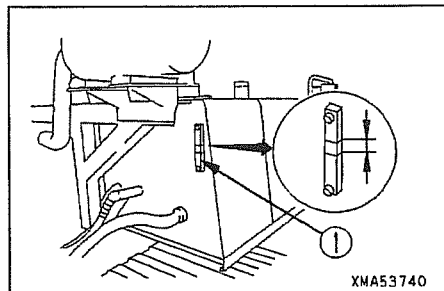

[5] CHECK DUST INDICATOR

Check if the red piston has appeared in the transparent portion of dust indicator (1).

If the red piston has appeared, clean or replace the element immediately.

★ For details of the method of cleaning the element, see "7.4 WHEN REQUIRED".

★ After checking, cleaning, or replacing, push the knob or dust indicator to return the red piston to its original position.

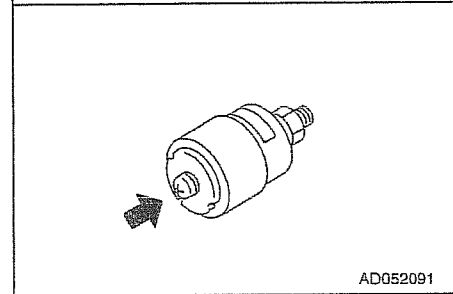
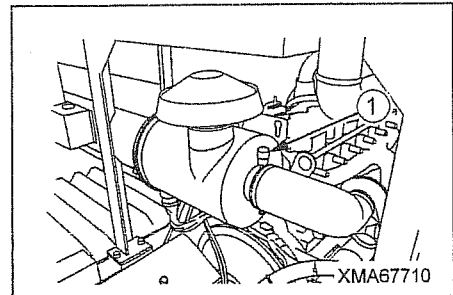

[6] DRAIN WATER, SEDIMENT FROM FUEL/WATER SEPARATOR

★ Set a container under the fuel/water separator to catch the fuel.

★ Fuel/water separator is installed to inside surface of the mainframe right end (main pump right end, forward of hydraulic line filter).

1. Go under the machine and install a suitable tube onto valve (2).
2. Loosen vent screw (3) at the head of the fuel/water separator (1).
3. Turn the valve (2) of the fuel/water separator (1) bottom to counterclockwise .
The water and sediment accumulated at the bottom of the fuel/water separator (1) will be drained together with the fuel.
4. After completely draining the sediment and water, turn the valve (2) of the fuel/water separator (1) bottom to clockwise , and close it.
5. Remove a suitable tube onto valve (2).
6. Tighten vent screw (3) at the head of the fuel/water separator (1).

★ Tightening torque: 6 Nm (53 lb in)

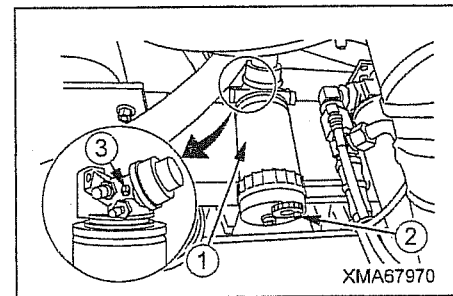

[7] CHECK, ADJUST COMPRESSOR BELT TENSION

• CHECKING TENSION

1. Open the engine inspection cover.
2. Push with your finger (approx. 58N {6kg}) at a point midway between the air compressor pulley (2) and tensioner pulley (1).

The deflection should be approx. 10 mm.

3. If the deflection is too large, adjust the belt tension. For details, see "ADJUSTING TENSION".
4. Remove the undercover.

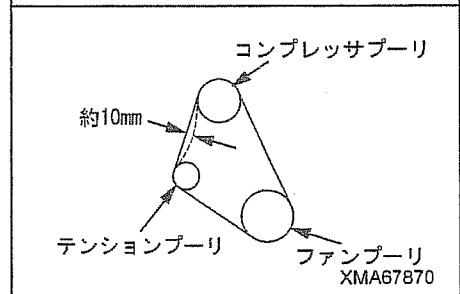
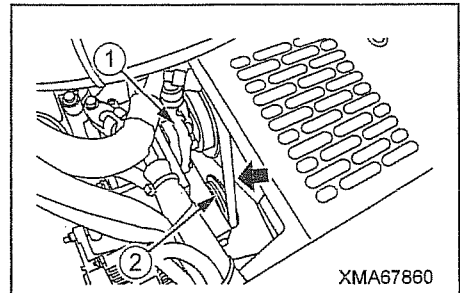

• ADJUSTING TENSION

1. Turn adjustment bolt (3) of the tension pulley (2) clockwise to adjust the belt of the air compressor (1) deflection to approx. 10 mm.
2. Repeat the procedure for checking the tension to check the belt tension again.
3. Close the engine inspection cover.

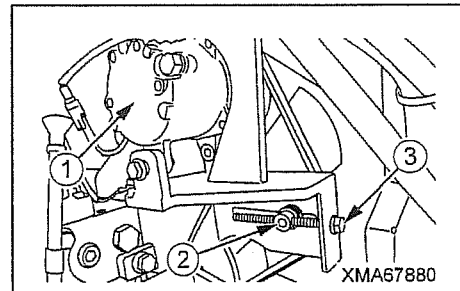

[8] CHECK ELECTRIC WIRING

DANGER

If any tool touches between the battery positive (+) terminal and the chassis, there is danger that sparks will be caused. Do not put tools and other metal objects in your breast pocket. They may fall out.

- Open the battery inspection cover, and check for looseness of the battery terminal, looseness of the ground connection and battery relay wiring, and for signs of short circuits.
- Open the engine inspection cover, and check for loose starting motor wiring and signs of short circuits.
- Open the engine inspection cover, and check loose alternator wiring and signs of short circuit.

[9] CHECK OPERATION OF SWITCHES, LAMPS, GAUGES

- Turn the starting switch to the ON position and check that the monitor lamps light up.
- Turn the starting switch to the ON position, operate the lamp switch and flasher switch (turn signal indicator) inside the combination switch, and check that each lamp lights up.
 - ★ If any lamp does not light up, the bulb is probably blown or there is a disconnection, so contact your distributor.
- Turn the starting switch to the ON position, operate the Hi-Lo speed range selector switch, and check that the high speed travel lamp on the instrument panel lights up.
 - ★ If high speed travel lamp does not light up, the bulb is probably blown or there is a disconnection, so contact your distributor.
- Turn the starting switch to the ON position, press the parking brake switch, and check that the parking lamp built-in the switch lights up.
 - ★ If parking lamp does not light up, the bulb is probably blown or there is a disconnection, so contact your distributor.
- Turn the starting switch to the ON position, operate the wiper switch, and check that the wiper motor action.
 - ★ If wiper motor does not acting, there is probably a failure or disconnection in the waiper motor, so contact your distributor.
- Turn the starting switch to the ON position, operate the air conditioner controller, and check that the air conditioner function.
 - ★ If air conditioner does not function, there is probably a failure or disconnection in the air conditioner unit, so contact your distributor.

[10] CHECK OPERATION OF HORN, ALARM BUZZER

- Turn the starting switch to the ON position, push the horn switch inside the combination switch, and check that the horn sounds.
 - ★ If the horn does not sound, there is probably a failure or disconnection in the horn, so contact your distributor.
- Turn the starting switch to the ON position, press the parking brake switch (built-in lamp lights up) and check that the buzzer sounds.
 - ★ If the parking brake buzzer does not sound, there is probably a failure or disconnection in the buzzer, so contact your distributor.
- Turn the starting switch to the ON position, operate the travel lever to the REVERSE position and check that the backup buzzer sounds.
 - ★ If the backup buzzer does not sound, there is probably a failure or disconnection in the buzzer or backup buzzer switch, so contact your distributor.

7.6 EVERY 50 HOURS SERVICE

[1] DRAIN WATER, SEDIMENT FROM FUEL TANK

★ Set a container under the fuel tank to catch the fuel.

1. Turn the plug (1) under the fuel tank to counterclockwise slightly.
The water and sediment accumulated at the bottom of the tank will be drained together with the fuel.
2. After completely draining the sediment and water, tighten the plug (1) under the fuel tank.

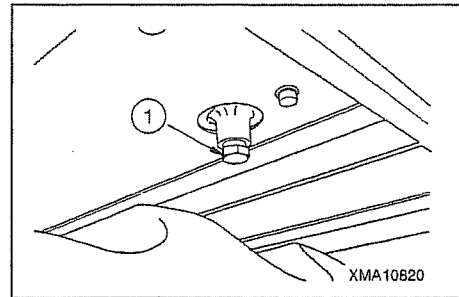

[2] CHECK FAN BELT FOR WEAR AND CRACKING

1. Open the engine inspection cover.
2. Inspect the belt (1) for wear and for cracking. Replace the belt if the belt (1) is worn or damaged.
 - If the belt (1) has more than four cracks per 25.4 mm (1 inch) the belt must be replaced.
 - Check the belt for the following items: cracks, splits, glazing, grease, splitting, and broken ribs
 - Remove any deposits that are on the belt.
3. Close the engine inspection cover.

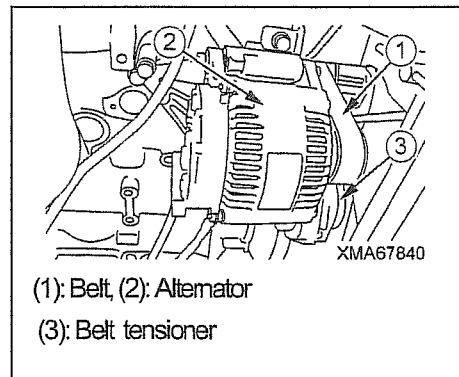

7.7 EVERY 100 HOURS SERVICE

★ Carry out "every-50 hours service" at the same time.

[1] CHECK BATTERY ELECTROLYTE LEVEL, ADD DISTILLED WATER

⚠ DANGER

- If any tool touches between the battery positive (+) terminal and the chassis, there is danger that sparks will be caused. Do not put tools and other metal objects in your breast pocket. They may fall out.
- Be careful not to get battery electrolyte on yourself or on your clothes.
- Do not bring any lighted cigarette or cigarette lighter close.

1. Open the battery inspection cover.
2. Remove all battery caps (1) and check the battery electrolyte level.
The battery electrolyte level should be approx. 10 - 12 mm above the plate.
3. If the battery electrolyte level is low, add distilled water.
 - ★ From time to time, measure the specific gravity of the battery, and charge if necessary.
4. Close the battery inspection cover.

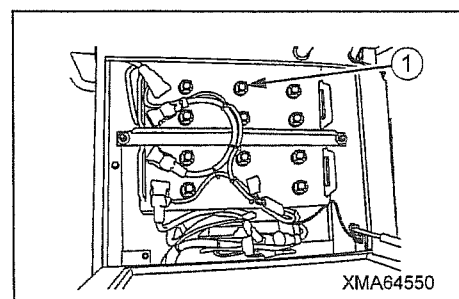

7.8 EVERY 250 HOURS SERVICE

Carry out "every-50 hours service and every-100 hours service" at the same time.

[1] CHANGE ENGINE LUBRICATING OIL, REPLACE ENGINE OIL FILTER

! WARNING

- Stop the engine and wait for the temperature to go down.
- After adding oil, tighten the cap and drain plug securely, then wipe up any spilled oil.

★ Set a container under the engine to catch the oil.

★ Prepare a filter wrench.

1. Go under the machine and remove the drain plug (3) from the engine oil pan and drain the oil.

★ Set the container under the engine oil pan to catch the oil.

★ Be careful not to get oil on yourself.

2. Check the drained oil.

★ If there are large amounts of metal particles or dirt in the drained oil, please contact your distributor.

3. After completely draining the oil, tighten the drain plug (3).

4. Using the filter wrench, turn the oil filter cartridge (4) to counterclockwise and remove it.

5. Clean the oil filter mount, coat the packing surface of the new oil filter cartridge with engine oil, then install it to the mount.

★ Fill the Engine oil into the new filter cartridge.

★ When installing a new filter cartridge, always tighten it by hand, and be careful not to tighten it too much.

For details, see the separate Operation and Maintenance Manual for the engine.

6. Open the engine inspection cover.

7. Remove the filler cap (2) and add the specified amount of engine oil.

★ For details of the oil to use, see "3. USE OF FUEL AND LUBRICANTS ACCORDING TO AMBIENT TEMPERATURE".

★ Engine oil refill amount: 16.5 liters (4.36 US gal, 3.63 UK gal)

★ Use a container with an attached hose when filling with oil.

8. Start the engine, run at idling for several minutes, then check that the oil is within the range between the top and bottom marks on the engine oil level gauge. For details, see "7.5 CHECK BEFORE STARTING".

9. Close the engine inspection cover.

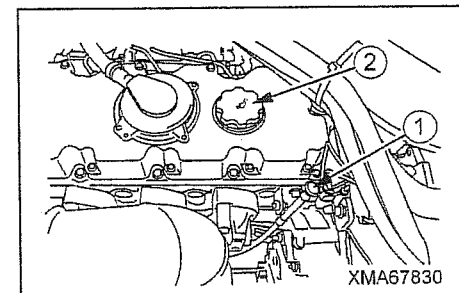
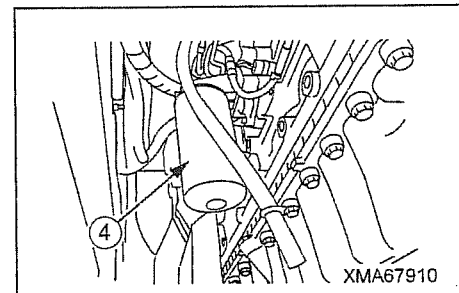
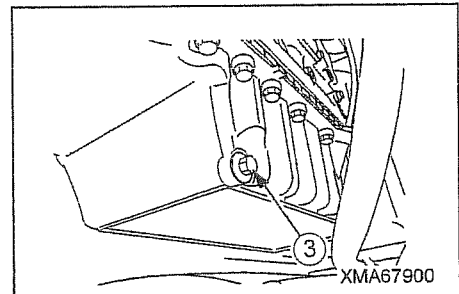

[2] GREASE ALL PARTS OF DUMP CYLINDER

★ Prepare a grease pump.

1. Raise the dump body. For details, see "OPERATION 4. OPERATING DUMP BODY".
2. Grease the bottom (left and right: 2 places) of the dump cylinder (1).
3. Grease the piston rod (left and right: 2 places) of the dump cylinder (1).

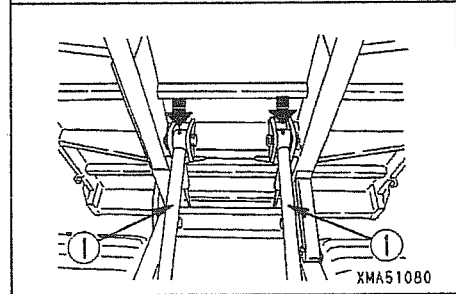
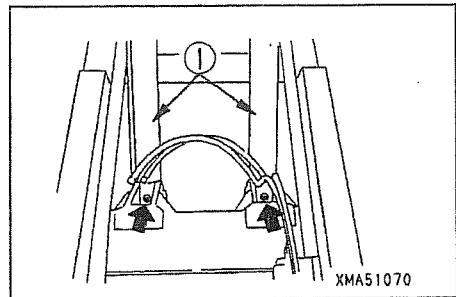

[3] GREASE DUMP BODY REAR SIDE FLAP OPERATING ROD

★ Prepare a grease pump.

1. Raise the dump body. For details, see "OPERATION 4. OPERATING DUMP BODY".
2. Grease the pin position (left and right: 4 places) of the flap operating rod (1).

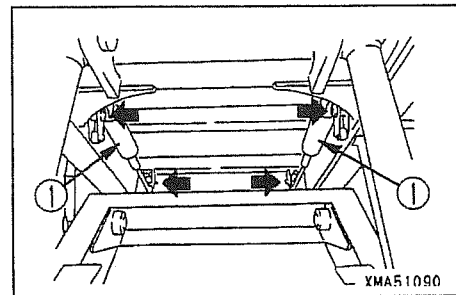

[4] GREASE DUMP BODY HINGE PIN

★ Prepare a grease pump.

1. Raise the dump body. For details, see "OPERATION 4. OPERATING DUMP BODY".
2. Grease the dump body hinge pin position (1) (left and right: 2 places).

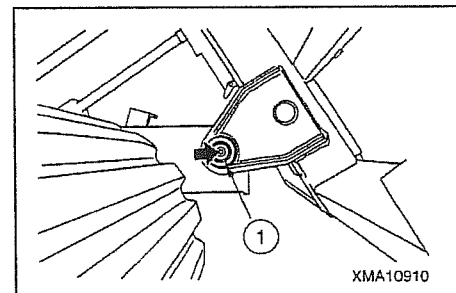

[5] GREASE DUMP BODY REAR SIDE FLAP OPERATING LEVER

★ Prepare a grease pump.

1. Raise the dump body. For details, see "OPERATION 4. OPERATING DUMP BODY".
2. Grease the pin position (left and right: 2 places) of the flap operating lever (1).

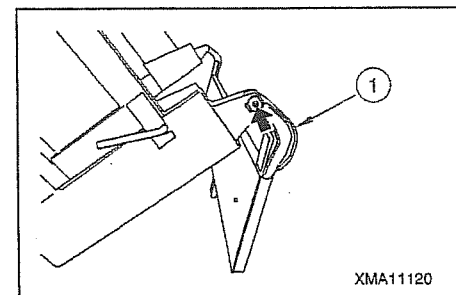

[6] GREASE TRACK ROLLER PIVOT SHAFT

★ Prepare a grease pump.

Grease the shaft position (12 places, each set 2 places x 6 sets) of the track roller pivot shaft (1).

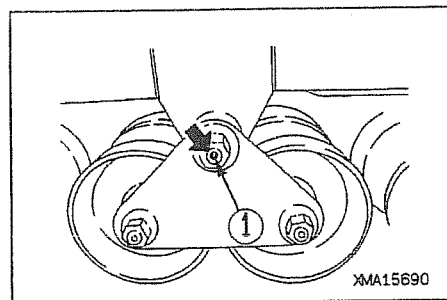

7.9 EVERY 500 HOURS SERVICE

Carry out "every-50 hours, every-100 hours and every-250 hours service" at the same time.

[1] REPLACE FUEL/WATER SEPARATOR

⚠ WARNING

- Stop the engine and wait for the engine to cool down.
- Do not smoke or bring any flame close.
- If any fuel leaks or overflows, always wipe it up immediately. If fuel gets on any high-temperature part, it will cause fire.

NOTICE

- After replacing the fuel/water separator, bleed the air from the fuel circuit. For details, see "7.4 WHEN REQUIRED [9]".
- The fuel/water separator is a cartridge type, so it cannot be used again.

- ★ Set a container under the fuel/water separator to catch the fuel.
 - ★ Prepare a filter wrench (1U-8760).
 - ★ Fuel/water separator is installed to inside surface of the mainframe right end (main pump right end, forward of hydraulic line filter).
1. Go under the machine, and install a suitable tube onto valve (2).
 2. Turn the valve (2) of the fuel/water separator (1) bottom to counterclockwise.
Allow the fluid to drain into the container.
★ After completely draining the fluid, remove the tube .
 3. Turn the valve (2) by hand pressure only.
 4. Turn the bowl (3) counterclockwise in order to remove the bowl (3).
★ Remove the O-ring (4) and clean the bowl (3).
 5. Using the filter wrench (1U-8760), turn the fuel/water separator (1) to counterclockwise and remove it.
 6. Clean the fuel/water separator mount, coat the O-ring surface of the new fuel/water separator (1) with engine oil, then install it to the mount correctly.
★ When installing a new fuel/water separator, always tighten it by hand to one turn, and be careful not to tighten it too much.
 7. Remove the cap (5) and O-ring (4) from the new fuel/water separator.
 8. Install a O-ring (4) into the bowl (3).
 9. Install the bowl (3) to the fuel/water separator (1) by hand correctly.

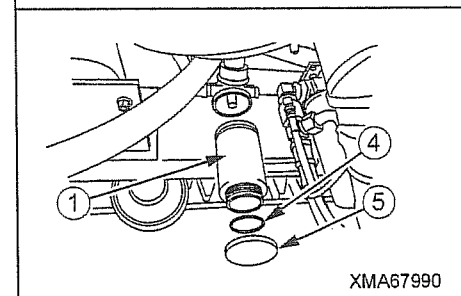
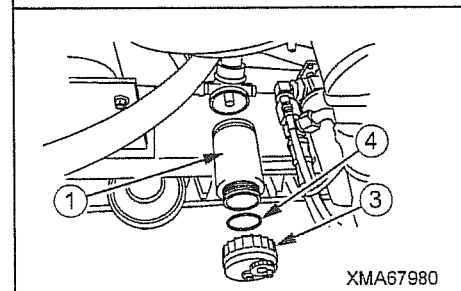
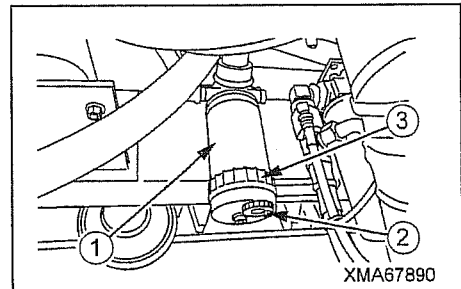

[2] REPLACE FUEL FILTER

⚠ WARNING

- Stop the engine and wait for the engine to cool down.
- Do not smoke or bring any flame close.

NOTICE

After replacing the fuel filter, bleed the air from the fuel circuit. For details, see "7.4 WHEN REQUIRED [9]".

★ Set a container under the fuel filter to catch the fuel.

★ Prepare a filter wrench (1U-8760).

1. Go under the machine, and using the filter wrench (1U-8760), turn the fuel filter cartridge (1) to counterclockwise and remove it.
2. Clean the fuel filter mount, coat the packing surface of the new fuel filter cartridge (1) with engine oil, then install it to the mount.

★ When installing a new fuel filter cartridge, always tighten it by hand, and be careful not to tighten it too much.

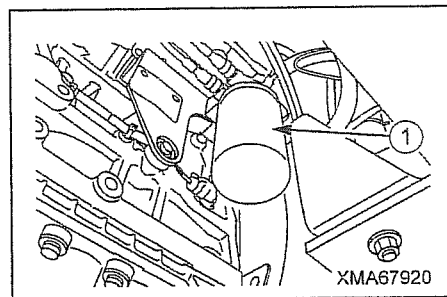

[3] REPLACE HYDRAULIC LINE FILTER

⚠ WARNING

- Stop the engine and wait for the engine to cool down.
- Loosen the cap of the hydraulic tank slowly to release the internal pressure completely, then remove the cap.
- Operate the travel lever and dump control lever 2 or 3 times to the end of their stroke to completely release the remaining pressure in the hydraulic circuit.

NOTICE

When replacing the hydraulic line filter, always change the oil in the hydraulic tank at the same time.

★ Set a container under the hydraulic line filter to catch the oil.

★ Prepare a filter wrench.

★ Fuel/water separator is installed to inside surface of the mainframe right end (main pump right end, backward of fuel/water separator).

1. Go under the machine, and using the filter wrench, turn the line filter cartridge (1) to counterclockwise and remove it.
2. Clean the line filter mount, coat the packing surface of the new line filter cartridge (1) with hydraulic oil, then install it to the mount.

★ Fill the hydraulic oil into the new filter cartridge.

★ When installing a new line filter cartridge, always tighten it by hand, and be careful not to tighten it too much.

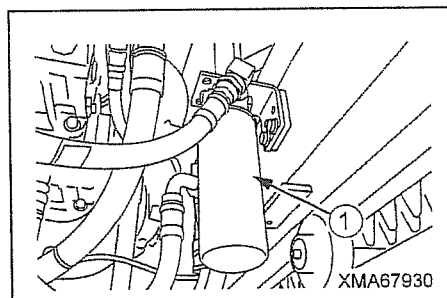

[4] CHANGE OIL IN HYDRAULIC TANK

⚠ WARNING

- Stop the engine and wait for the engine to cool down.
- Loosen the oil filler cap slowly to release the pressure inside the hydraulic tank, then remove the cap.
- Make full stroke operations of the travel lever and the damp control lever to release the remaining pressure inside the hydraulic circuits totally.
- After adding oil, tighten the cap and drain plug securely, then wipe up any spilled oil.

NOTICE

- When changing the oil in the hydraulic tank, always replace the hydraulic line filter at the same time.
- Always replace the O-ring used inspection cover inside the hydraulic tank with a new O-ring.

★ Set a container under the hydraulic tank to catch the oil.

1. Remove the filler cap (2) on the hydraulic tank.
2. Turn drain plug (3) at the bottom of the hydraulic tank to counterclockwise and drain the oil from the hydraulic tank.

★ Set the container under the hydraulic tank to catch the oil.

★ Be careful not to get oil on yourself.

3. Inspect the drained oil.

★ If there are large amounts of metal particles or dirt in the drained oil, please contact your distributor.

4. After completely draining the oil, tighten drain plug (3).
5. Remove the 8 bolts, then remove the inspection cover (4).

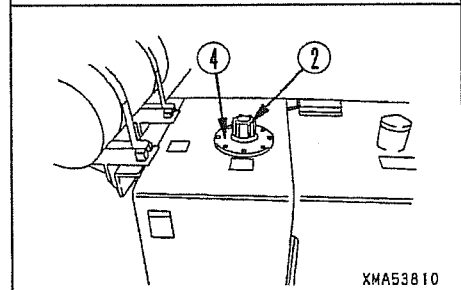
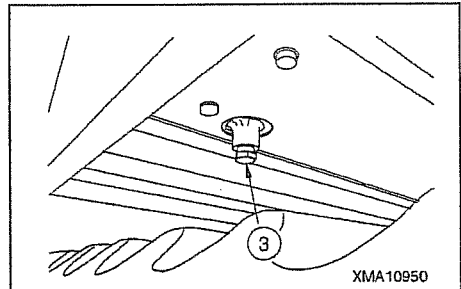

6. Take out the oil strainer (5) from the hydraulic tank, then wash it in diesel oil.
7. Install the oil strainer (5) inside the hydraulic tank, set new O-ring (6) to the hydraulic tank, then install inspection cover (4) and tighten the bolts.
8. Fill with hydraulic oil through the oil filler.

★ For details of the hydraulic oil to use, see "3. USE OF FUEL, COOLANT, AND LUBRICANT ACCORDING TO AMBIENT TEMPERATURE".

★ Hydraulic oil refill amount: 92 liters (24.31 US gal, 20.24 UK gal)

★ Use a container with an attached hose when filling with oil.

9. Check that the oil level is between the top and bottom red lines on the level gauge at the rear of the hydraulic tank. For details, see "7.5 CHECK BEFORE STARTING (4)".

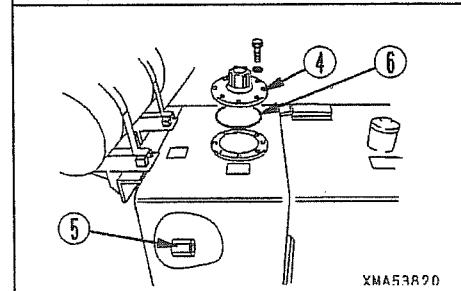

7.10 EVERY 1500 HOURS SERVICE

Carry out "every-50 hours, every-100 hours, every-250 hours and every-500 hours service" at the same time.

[1] CHANGE OIL INSIDE TRAVEL MOTOR REDUCTION GEAR CASE

⚠ WARNING

- Stop the engine and wait for the oil temperature to go down.
- After adding oil, tighten the plugs securely and wipe up any spilled oil.

★ Set a container under the travel motor reduction gear case to catch the oil.

1. Drive the machine forward or backward to position drain plug (1) of the reduction gear case at the bottom, then stop the engine.

2. Remove the oil filler plug (3), oil level inspection plug (2), and drain plug (1), and drain the oil from the case.

★ Set the container under the travel motor to catch the oil.

3. Inspect the drained oil.

★ If there are large amounts of metal particles or dirt in the drained oil, please contact your distributor.

4. After the oil has been completely drained, tighten drain plug (1).

5. Add the specified amount of gear oil through the oil filler plug (3), and check that oil comes out from the oil level inspection plug (2) hole.

★ For details of the gear oil, see "3. USE OF FUEL AND LUBRICANTS ACCORDING TO AMBIENT TEMPERATURE".

★ Specified amount of gear oil: 3.9 liters (1.03 US gal, 0.86 UK gal)

6. Tighten the oil filler plug (3) and the oil level inspection plug (2).

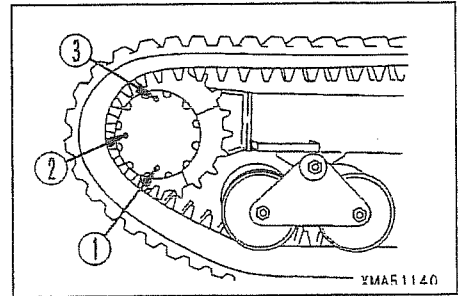

SPECIFICATIONS

1. DIMENSION DRAWING	4-2
2. SPECIFICATIONS TABLE	4-3

1. DIMENSION DRAWING

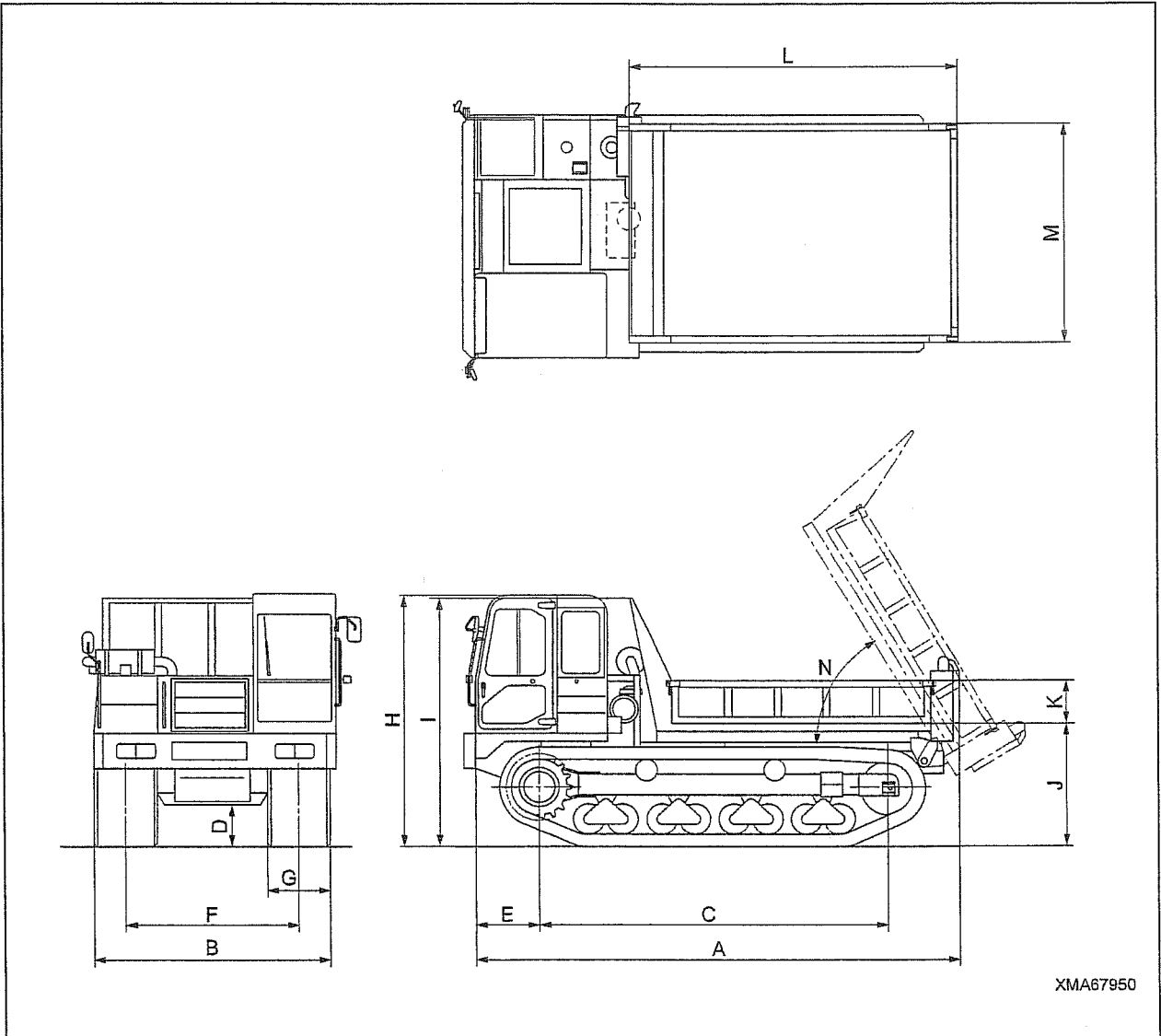

2.SPECIFICATIONS TABLE

Model name			MST-1500VD
A	Overall length	(mm)	5,430
B	Overall width	(mm)	2,750
C	Distance between center of idler and center of sprocket	(mm)	3,870
D	Min. ground clearance	(mm)	460
E	Distance between front of machine and center of sprocket	(mm)	770
F	Track gauge	(mm)	1,800
G	Track width	(mm)	700
H	Overall height (cab roof top)	(mm)	2,900
I	Overall height (dump body top)	(mm)	2,750
J	Clearance between ground and bottom of dump body	(mm)	1,350
K	Dump body height	(mm)	350
L	Dump body length	(mm)	3,100
M	Dump body width	(mm)	2,200
N	Max. dumping angle	(deg)	60
Mass (weight) of machine		(kg)	9,200
Max. payload		(kg)	6,300
Drive system			Fully hydraulic system (HST)
Speed change system			Step-less speed change
Travel speed (at high speed range)		(km/h)	0 – 11km/h
Travel speed (at low speed range)		(km/h)	0 – 7.6km/h
Ground contact pressure (unloaded)		(kPa {kg·f/cm ² })	16.8 {0.17}
Ground contact pressure (loaded)		(kPa {kg·f/cm ² })	27.9 {0.28}
Engine model			Caterpillar C6.6
Engine type			Water-cooled, 4-cycle, in-line upright Direct injection type, with turbocharger, air cooled inter cooler
No. of cylinders – bore x stroke		(mm)	6 – 105 x 127
Piston displacement		(Liter)	6.6
Rated output/engine speed		(kW/min ⁻¹)	168/2,200
Max. torque/engine speed		(N·m/min ⁻¹)	986/1,400
Fuel			Diesel oil
Fuel consumption ratio		(Liter)	156
Battery			(12V, 96Ah) X 2 (130F51)

RUBBER CRAWLER CARRIER MST—1500VD
OPERATION AND MAINTENANCE MANUAL

Document No.AE11500VD2C-01

First edition: November 15, 2010

Issued by Morooka Co., Ltd.
358 Shoubeisindencho, Ryugasaki,
Ibaraki 301-0034,
Japan

No part of this manual can be reproduced in any form without permission

SPECIFICATIONS

Whole Body Vibrations:

The weighted root mean square vibration acceleration to which the operator is subjected through the seat is unlikely to exceed 0.6ms^2 . Tests are conducted under relatively harsh conditions, and in most conditions lower magnitudes of acceleration can be anticipated. Only in certain particularly severe conditions is this value likely to be exceeded.

Hand/arm Vibrations

This machine does not transmit vibration greater than 2.5ms^2 to the operators hand or arms.

Noise levels

MST1500VD

- | | | |
|----|------------------------------------|----|
| 1. | Noise level at operators ear (LpA) | 86 |
| 2. | External noise level (LWA) | 98 |

MOROOKA CO., LTD.