

# KOMATSU

## PC228USLC-11

EU Stage IV Engine

HYDRAULIC EXCAVATOR

PC228



**ENGINE POWER**

123 kW / 165 HP @ 2.000 rpm

**OPERATING WEIGHT**

23.600 - 24.150 kg

**BUCKET CAPACITY**

max. 1,49 m<sup>3</sup>

# Walk-Around

PC228USLG-11



**ENGINE POWER**

123 kW / 165 HP @ 2.000 rpm

**OPERATING WEIGHT**

23.600 - 24.150 kg

**BUCKET CAPACITY**

max. 1,49 m<sup>3</sup>



## EXCEPTIONAL WORKABILITY AND ENVIRONMENTAL PERFORMANCE

### ***Powerful and Environmentally Friendly***

- EU Stage IV engine
- Adjustable idle shutdown
- Komatsu fuel-saving technology
- Engine fan clutch
- Up to 21% higher lifting capacity

### ***Maximised Efficiency***

- Increased productivity
- Built-in versatility and superior productivity
- Short tail swing and exceptional stability
- Enhanced engine management
- Improved hydraulic efficiency

### ***First-Class Comfort***

- Fully air-suspended operator station
- Low-noise design
- Widescreen monitor with evolutionary interface
- Improved operator convenience

### ***Safety First***

- Komatsu SpaceCab™
- Improved monitoring system
- Neutral position detection system
- KomVision surround view system

### ***Quality You Can Rely On***

- Komatsu-quality components
- Extensive dealer support network

### ***KOMTRAX***

- Komatsu Wireless Monitoring System
- 3G mobile communications
- Integrated communication antenna
- Increased operational data and reports



A maintenance program  
for Komatsu customers



# Powerful and Environmentally Friendly



## Higher productivity

The PC228USLC-11 is quick and precise. It features a powerful Komatsu EU Stage IV engine, Komatsu's Closed Center Load Sensing (CLSS) hydraulic system and first-class Komatsu comfort to provide a fast response and unrivalled productivity for its class.

## Komatsu fuel-saving technology

Fuel consumption on the PC228USLC-11 is lower by up to 6%. Engine management is enhanced. The variable speed matching of the engine and hydraulic pump and a viscous fan clutch guarantee efficiency and precision during single and combined movements.

## Adjustable idle shutdown

The Komatsu auto idle shutdown automatically turns off the engine after it idles for a set period of time. This feature can easily be programmed from 5 to 60 minutes, to reduce unnecessary fuel consumption and exhaust emissions, and to lower operating costs. An Eco-gauge and the Eco guidance tips on the cab monitor further encourage efficient operations.

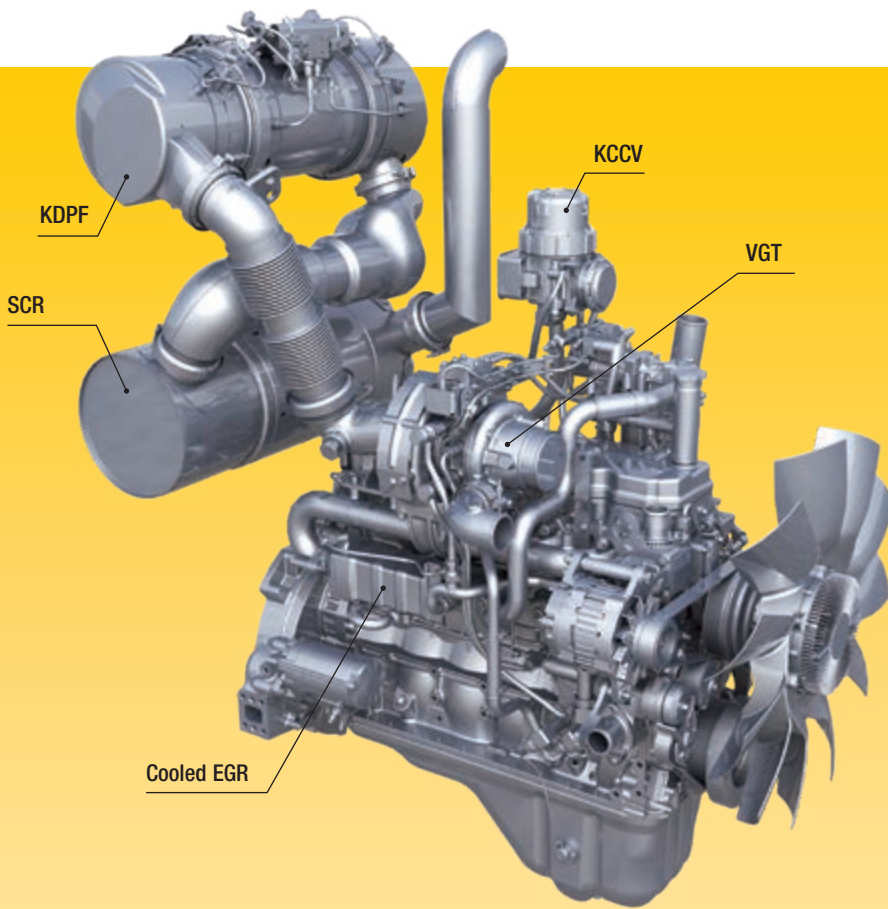

## Komatsu EU Stage IV

The Komatsu EU Stage IV engine is productive, dependable and efficient. With ultra-low emissions, it provides a lower environmental impact and a superior performance to help reduce operating costs and lets the operator work in complete peace of mind.

## Heavy-duty aftertreatment

The aftertreatment system combines a Komatsu Diesel Particulate Filter (KDPF) and Selective Catalytic Reduction (SCR). The SCR injects the correct amount of AdBlue® into the system at the proper rate to break down NOx into water (H<sub>2</sub>O) and non-toxic nitrogen gas (N<sub>2</sub>). NOx emissions are reduced by 80% vs. EU Stage IIIB engines.

### Exhaust Gas Recirculation (EGR)

Cooled EGR is a technology well-proven in current Komatsu engines. The increased capacity of the EGR cooler now ensures very low NOx emissions and a better engine performance.

### Komatsu Closed Crankcase Ventilation (KCCV)

Crankcase emissions (blow-by gas) are passed through a CCV filter. The oil mist trapped in the filter is returned back to the crankcase while the filtered gas is returned to the air intake.

### High-Pressure Common Rail (HPCR)

To achieve complete fuel burn and lower exhaust emissions, the heavy-duty High-Pressure Common Rail fuel injection system is computer controlled to deliver a precise quantity of pressurised fuel into the redesigned engine combustion chamber by multiple injections.

### Variable Geometry Turbo (VGT)

The VGT provides optimal airflow to the engine combustion chamber under all speed and load conditions. Exhaust gas is cleaner, fuel economy is improved while machine power and performance are maintained.

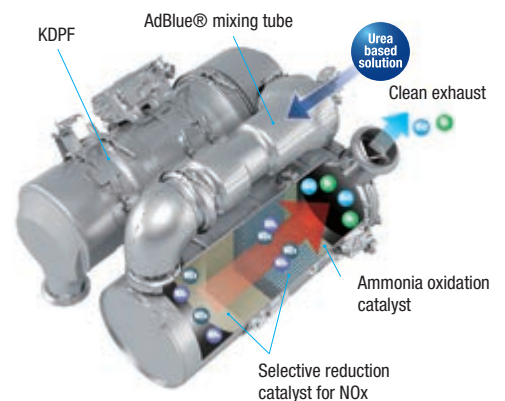

Eco-gauge, Eco guidance and fuel consumption gauge



ECO guidance record

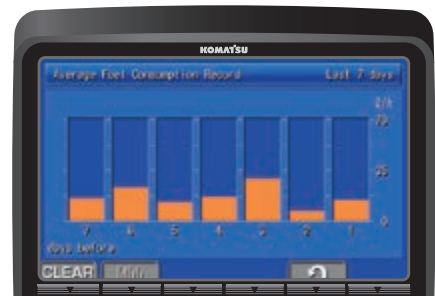

Fuel consumption history



# Maximised Efficiency

## Short tail swing and exceptional stability

The PC228USLC-11 has a rounded profile with minimal protrusions at both the front and the rear. Its ultra-short tail swing radius is perfect for work in tight spaces, particularly in urban areas, or for road construction, logging and demolition. Thanks to optimised packaging, the PC228USLC-11 is exceptionally stable.

Coupled with the machine's wide working range, this stability makes it ideal for any work requiring long reach, such as demolition jobs and slope cutting. With ample dumping reach available for loading operations, the operator can always work easily, efficiently and with absolute confidence.



Two optional hydraulic lines to mount a variety of attachments



Full length track roller guards (optional)



Versatility at your fingertips: select the perfect setting for each job

## Built-in versatility

Powerful and precise, the Komatsu PC228USLC-11 is equipped to efficiently carry out any task your business requires. On all jobsites, big or small, for digging, trenching, landscaping or site preparation, the Komatsu hydraulic system always provides maximum productivity and control.

## A wide choice of options

Two optional attachment lines are available and ten attachment memory settings are simply customised. Combined with a standard-fit hydraulic quick coupler power circuit, it's easier than ever to switch working styles. With a choice of arms and undercarriages, you can configure the PC228USLC-11 to match specific demands for transport, working envelope or duty.

## 6 working modes

The PC228USLC-11 delivers the power required with the lowest fuel usage. 6 working modes are available: Power, Lifting/Fine Operation, Breaker, Economy, Attachment Power and Attachment Economy. The operator can ideally balance the Economy mode between power and economy to match the work at hand. The oil flow delivered to hydraulic attachments is also adjustable directly on the class-leading widescreen monitor panel.

PC228USLC-11







# First-Class Comfort

## Increased comfort

In the wide Komatsu SpaceCab™, a standard air-suspended high-back seat, heated for improved comfort and with fully adjustable armrests, is the centre of a comfortable and low-fatigue working environment. High visibility and ergonomic controls further assist to maximise the operator's productivity.

## Perfect operator convenience

In addition to the standard radio, the PC228USLC-11 has an auxiliary input for connecting external devices and play music through the cab speakers. Two 12-volt power ports are also incorporated in the cab. Proportional controls are fitted as standard for safe and precise operation of attachments.

## Low-noise design

Komatsu crawler excavators have very low external noise levels and are especially well-suited for work in confined spaces or urban areas. The optimal usage of sound insulation and of sound absorbing materials helps to make noise levels inside the cab comparable to those of an executive car.



Convenient, ergonomic and precise control: joysticks with proportional control button for attachments



Automatic air conditioner



Magazine box



# Information & Communication Technology



## Lower operating costs

Komatsu ICT contributes to the reduction of operating costs by assisting to comfortably and efficiently manage operations. It raises the level of customer satisfaction and the competitive edge of our products.

## Widescreen monitor

Installed with a choice of 26 languages, the widescreen monitor with simple switches and multifunction keys gives fingertip access to a large range of functions and operating info.

## An evolutionary interface

Helpful information is now easier than ever to find and understand with the upgraded monitor interface. An optimal main screen for the ongoing work can be selected simply by pressing the F3 key.



Quick view on the operation logs



With KomVision, various camera view options are available whilst maintaining constant "birdview" from above the machine

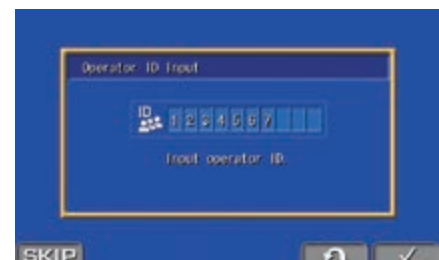

Operator identification function

# Safety First

## Optimal jobsite safety

Safety features on the Komatsu PC228USLC-11 comply with the latest industry standards and work in synergy to minimise risks to people in and around the machine. A neutral detection system for travel and work equipment levers increase jobsite safety, along with a seat belt caution indicator and an audible travel alarm. Highly durable anti-slip plates – with additional high friction covering – maintain long term traction performance.

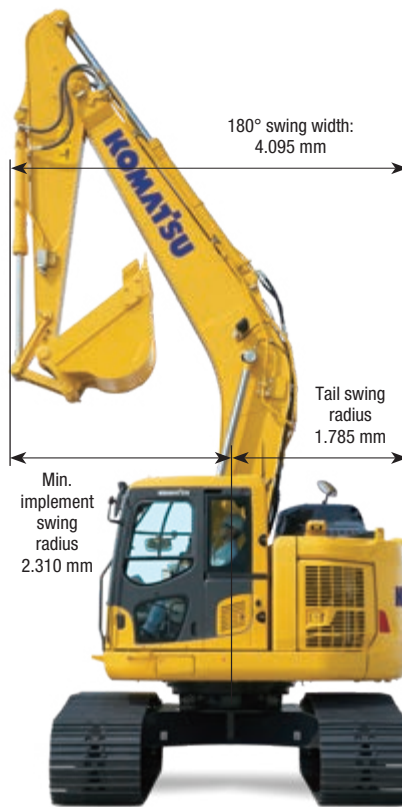

## Short tail swing radius

1,79 m – Because the tail of the PC228USLC-11 is more compact than conventional models, the operator's need to check behind him for movement.

## Short implement swing radius

2,31 m – Boom raising angle of the PC228USLC-11 is larger than the PC210-11, while front implement protrusion is lessened.



*KomVision cameras*



*Exceptional operator protection*



*Hand rails and anti-slip plates*

## KomVision

KomVision machine visibility gives the operator a constant clear view of the safety zone around the machine. This allows the operator to focus on the work at hand even in low light conditions.

## Komatsu SpaceCab™

The ROPS cab has a tubular steel frame and provides high shock absorbency, impact resistance and durability. The seat belt is well designed to keep the operator in the safety zone of the cab in the event of a rollover. Optionally the cab can be fitted with a Falling Object Protective System (FOPS) with openable front guard.

## Safe maintenance

Thermal guards around high temperature areas of the engine, protected fan belt and pulleys, a pump/engine partition that prevents hydraulic oil from spraying onto the engine, and exceptionally sturdy handrails: in Komatsu tradition, the highest safety level is provided for a fast and smooth maintenance.



# Quality You Can Rely On

## Komatsu-quality

With the latest computer techniques and a thorough test programme, Komatsu produces equipment to meet your highest standards.

All major components of the PC228USLC-11 are designed and directly manufactured by Komatsu, and essential machine functions are perfectly matched for a highly reliable and productive excavator.

## Rugged design

Maximum toughness and durability are the cornerstones of Komatsu's philosophy – along with safety and top class customer service. Single piece plates and castings are used in key areas of the machine's structure for good load distribution. Highly durable rubbing strips on the underside of the arm protect the structure against impact damage.

## Extensive support network

The extensive Komatsu distribution and dealer network is standing by to help keep your fleet in optimum condition. Customised servicing packages are available, with express availability of spare parts, to make sure that your Komatsu equipment continues to perform at its peak.



*The sliding door facilitates easy entrance in confined areas while reducing the risk of damage on roadways.*



*Durable and reliable undercarriage design for maximum protection*



*Cast boom foot and single piece boom plates*

# Easy Maintenance



## Central service points

Komatsu designed the PC228USLC-11 with centralised and conveniently located service points to make necessary inspections and maintenance quick and easy.

## Komatsu CARE™

Komatsu CARE™ is a maintenance program that comes as standard with your new Komatsu machine. It covers factory-scheduled maintenance, performed with Komatsu Genuine parts by Komatsu-trained technicians. Depending on your machine's engine, it also offers extended coverage of the Komatsu Diesel Particulate Filter (KDPF) or the Komatsu Diesel Oxidation Catalyst (KDOC), and of the Selective Catalytic Reduction (SCR). Please contact your local Komatsu distributor for terms and conditions.



## Long-life oil filters

The Komatsu Genuine hydraulic oil filter uses high-performance filtering material for long replacement intervals, which significantly reduces maintenance costs.



## AdBlue® tank

For simple access, the AdBlue® tank is installed on the front stairway.

## Flexible warranty

When you purchase Komatsu equipment, you gain access to a broad range of programmes and services that have been designed to help you get the most from your investment. For example, Komatsu's Flexible Warranty Programme provides a range of extended warranty options on the machine and its components. These can be chosen to meet your individual needs and activities. This programme is designed to help reduce total operating costs.

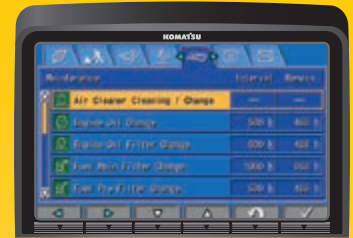

Basic maintenance screen

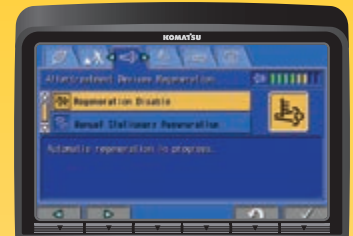

Aftertreatment device regeneration screen for the KDPF

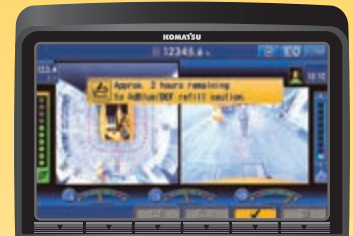

AdBlue® level and refill guidance





# KOMTRAX

## The way to higher productivity

KOMTRAX uses the latest wireless monitoring technology. Compatible on PC, smartphone or tablet, it delivers insightful and cost saving information about your fleet and equipment, and offers a wealth of information to facilitate peak machine performance. By creating a tightly integrated web of support it allows proactive and preventive maintenance and helps to efficiently run a business.



## Knowledge

You get quick answers to basic and critical questions about your machines – what they're doing, when they did it, where they're located, how they can be used more efficiently and when they need to be serviced.

Performance data is relayed by wireless communication technology (satellite, GPRS or 3G depending on model) from the machine to a computer and to the local Komatsu distributor – who's readily available for expert analysis and feedback.

## Power

The detailed information that KOMTRAX puts at your fingertips 24 hours a day, 7 days a week gives the power to make better daily and long-term strategic decisions – at no extra cost. Problems can be anticipated, maintenance schedules customised, downtime minimised and machines kept where they belong: working on the jobsite.

## Convenience

KOMTRAX enables convenient fleet management on the web, wherever you are. Data is analysed and packaged specifically for effortless and intuitive viewing in maps, lists, graphs and charts. You can foresee eventual maintenance issues and required spare parts, and troubleshoot a problem before Komatsu technicians arrive on site.



# Specifications

## ENGINE

|                             |   |
|-----------------------------|---|
| Model                       | Komatsu SAA6D107E-3   |
| Type                        | Common rail direct injection, water-cooled, emissionised, turbocharged, after-cooled diesel                               |
| Engine power                |   |
| at rated engine speed       | 2.000 rpm   |
| ISO 14396                   | 123 kW/165 HP   |
| ISO 9249 (net engine power) | 123 kW/165 HP   |
| No. of cylinders            | 6   |
| Bore × stroke               | 107 × 124 mm  |
| Displacement                | 6,69 l  |
| Air filter type             | Double element type with monitor panel dust indicator and auto dust evacuator   |
| Cooling                     | Suction type cooling fan with radiator fly screen   |
| Fuel                        | Diesel fuel, conforming to EN590 Class 2/Grade D. Paraffinic fuel capability (HVO, GTL, BTL), conforming to EN 15940:2016 |

## HYDRAULIC SYSTEM

|                       |   |
|-----------------------|---|
| Type                  | HydrauMind. Closed-centre system with load sensing and pressure compensation valves         |
| Additional circuits   | 2 additional circuits with proportional control can be installed                            |
| Main pump             | 2 variable displacement piston pumps supplying boom, arm, bucket, swing and travel circuits |
| Maximum pump flow     | 490 l/min   |
| Relief valve settings |   |
| Implement             | 380 kg/cm <sup>2</sup>  |
| Travel                | 380 kg/cm <sup>2</sup>  |
| Swing                 | 300 kg/cm <sup>2</sup>  |
| Pilot circuit         | 33 kg/cm <sup>2</sup>   |

## SERVICE REFILL CAPACITIES

|                         |        |
|-------------------------|--------|
| Fuel tank               | 290 l  |
| Radiator                | 30 l   |
| Engine oil              | 23,1 l |
| Swing drive             | 6,5 l  |
| Hydraulic tank          | 126 l  |
| Final drive (each side) | 5,0 l  |
| AdBlue® tank            | 13 l   |

## OPERATING WEIGHT (APPR.)

| Triple grouser shoes | Operating weight | Ground pressure         |
|----------------------|------------------|-------------------------|
| 600 mm               | 23.600 kg        | 0,50 kg/cm <sup>2</sup> |
| 700 mm               | 23.870 kg        | 0,43 kg/cm <sup>2</sup> |
| 800 mm               | 24.150 kg        | 0,38 kg/cm <sup>2</sup> |
| 600 mm road liner    | 23.460 kg        | 0,49 kg/cm <sup>2</sup> |

Operating weight, including specified work equipment, 2,9 m arm, 650 kg bucket, operator, lubricant, coolant, full fuel tank and the standard equipment.

## SWING SYSTEM

|              |   |
|--------------|---|
| Type         | Axial piston motor driving through planetary double reduction gearbox |
| Swing lock   | Electrically actuated wet multidisc brake integrated into swing motor |
| Swing speed  | 0 - 11 rpm  |
| Swing torque | 65 kNm  |

## DRIVES AND BRAKES

|                      |  |
|----------------------|--|
| Steering control     | 2 levers with pedals giving full independent control of each track |
| Drive method         | Hydrostatic  |
| Travel operation     | Automatic 3-speed selection  |
| Gradeability         | 70%, 35°   |
| Max. travel speeds   |  |
| Lo / Mi / Hi         | 3,0 / 4,1 / 5,5 km/h   |
| Maximum drawbar pull | 20.600 kg  |
| Brake system         | Hydraulically operated discs in each travel motor                  |

## UNDERCARRIAGE

|                             |  |
|-----------------------------|--|
| Construction                | X-frame centre section with box section track frames |
| Track assembly              |  |
| Type                        | Fully sealed   |
| Shoes (each side)           | 49   |
| Tension                     | Combined spring and hydraulic unit                   |
| Rollers                     |  |
| Track rollers (each side)   | 9  |
| Carrier rollers (each side) | 2  |

## ENVIRONMENT

|   |   |
|---|---|
| Engine emissions  | Fully complies with EU Stage IV exhaust emission regulations    |
| Noise levels  |   |
| LwA external  | 100 dB(A) (2000/14/EC Stage II)                                 |
| LpA operator ear  | 71 dB(A) (ISO 6396 dynamic test)                                |
| Vibration levels (EN 12096:1997)  |   |
| Hand/arm  | ≤ 2,5 m/s <sup>2</sup> (uncertainty K = 0,51 m/s <sup>2</sup> ) |
| Body  | ≤ 0,5 m/s <sup>2</sup> (uncertainty K = 0,30 m/s <sup>2</sup> ) |
| Contains fluorinated greenhouse gas HFC-134a (GWP 1430).<br>Quantity of gas 0,8 kg, CO <sub>2</sub> equivalent 1,14 t |   |



# Dimensions & Performance Figures

## MACHINE DIMENSIONS

|    |                                       |                  |
|----|---------------------------------------|------------------|
| A  | Overall width of upper structure      | 2.980 mm         |
| B  | Overall height (top of cab)           | 3.065 mm         |
| B' | Overall height (top of handrail)      | 3.255 mm         |
| C  | Overall length of basic machine       | 4.450 mm         |
| D  | Tail length                           | 1.785 mm         |
|    | Tail swing radius                     | 1.785 mm         |
| E  | Clearance under counterweight         | 1.075 mm         |
| F  | Machine tail height                   | 2.915 mm         |
| G  | Ground clearance                      | 440 mm           |
| H  | Tumbler centre distance               | 3.655 mm         |
| I  | Track length                          | 4.450 mm         |
| J  | Track gauge                           | 2.380 mm         |
| K  | Track shoe width                      | 600, 700, 800 mm |
| L  | Overall track width with 600 mm shoes | 2.980 mm         |
|    | Overall track width with 700 mm shoes | 3.080 mm         |
|    | Overall track width with 800 mm shoes | 3.180 mm         |

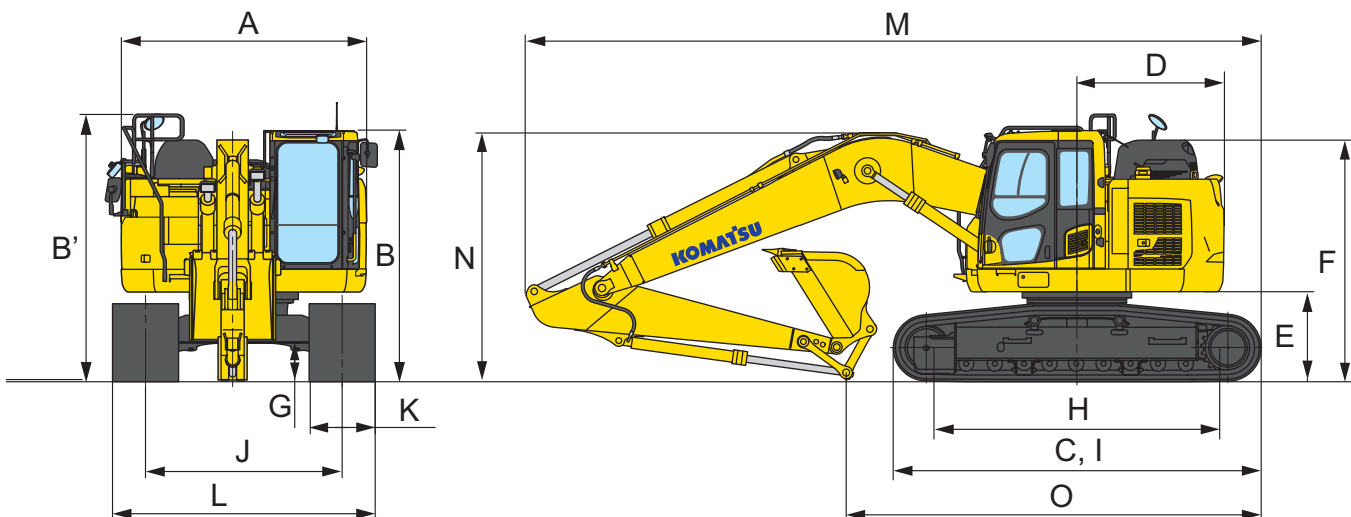

## TRANSPORT DIMENSIONS

|   |                                 |          |          |
|---|---------------------------------|----------|----------|
|   | Arm length                      | 2,4 m    | 2,9 m    |
| M | Transport length                | 8.980 mm | 8.920 mm |
| N | Overall height (to top of boom) | 3.165 mm | 3.040 mm |
| O | Length on ground (transport)    | 5.890 mm | 5.050 mm |

# Dimensions & Performance Figures

## MAX. BUCKET CAPACITY AND WEIGHT

| Arm length                                 | 2,4 m                        | 2,9 m                        |
|--|------------------------------|------------------------------|
| Material weight up to 1,2 t/m <sup>3</sup> | 1,49 m <sup>3</sup> 1.100 kg | 1,37 m <sup>3</sup> 1.000 kg |
| Material weight up to 1,5 t/m <sup>3</sup> | 1,36 m <sup>3</sup> 1.100 kg | 1,26 m <sup>3</sup> 950 kg   |
| Material weight up to 1,8 t/m <sup>3</sup> | 1,18 m <sup>3</sup> 900 kg   | 1,10 m <sup>3</sup> 875 kg   |

## BUCKET AND ARM FORCE

| Arm length                       | 2,4 m     | 2,9 m     |
|----------------------------------|-----------|-----------|
| Bucket digging force             | 16.500 kg | 14.100 kg |
| Bucket digging force at PowerMax | 17.500 kg | 15.200 kg |
| Arm crowd force                  | 12.200 kg | 10.300 kg |
| Arm crowd force at PowerMax      | 13.000 kg | 11.000 kg |





# Working Range

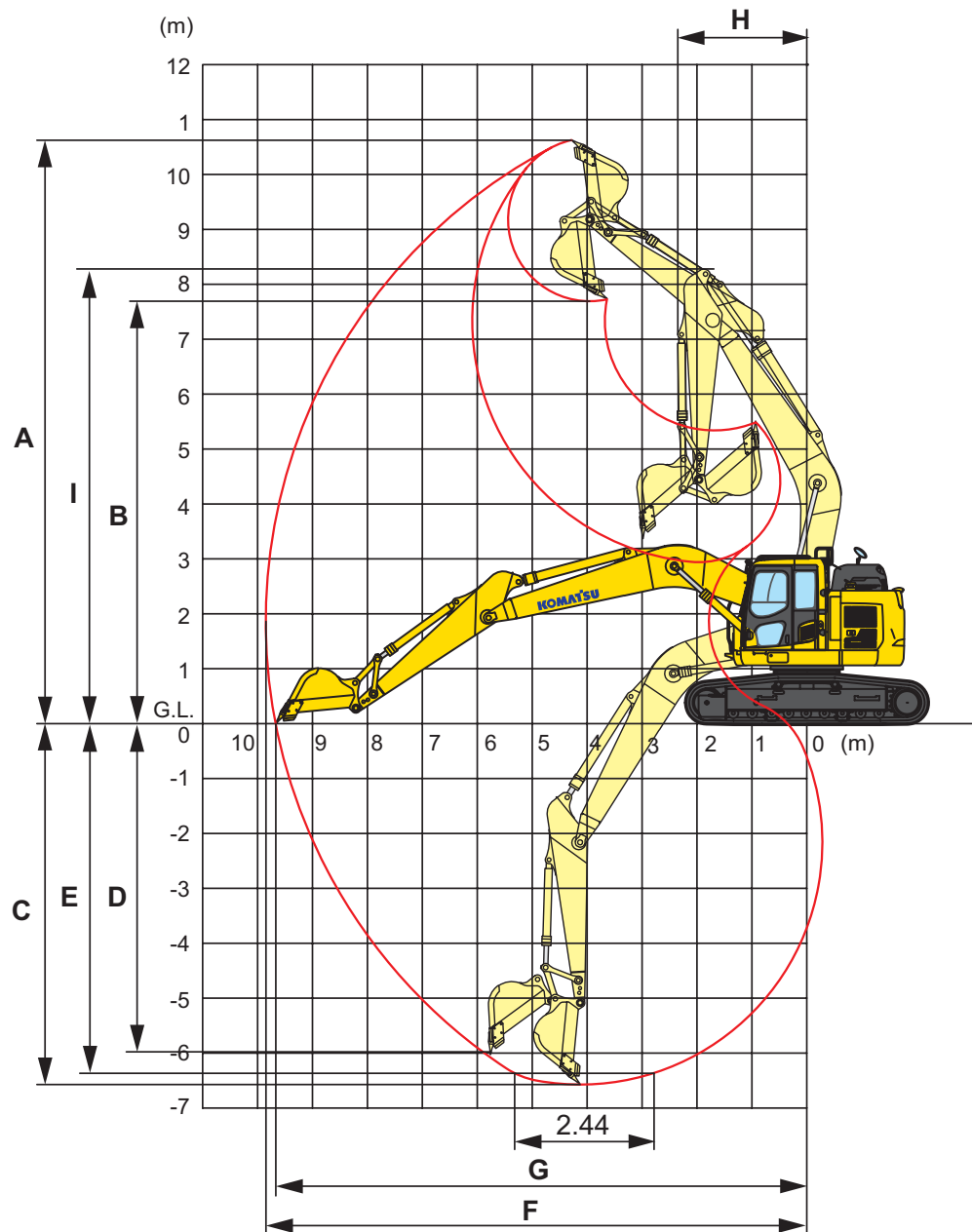

## WORKING RANGE

| Arm length                                   | 2,4 m     | 2,9 m     |
|--|-----------|-----------|
| A Max. digging height                        | 10.380 mm | 10.700 mm |
| B Max. dumping height                        | 7.470 mm  | 7.825 mm  |
| C Max. digging depth                         | 6.095 mm  | 6.620 mm  |
| D Max. vertical wall digging depth           | 5.315 mm  | 5.980 mm  |
| E Max. digging depth of cut for 2,44 m level | 5.840 mm  | 6.370 mm  |
| F Max. digging reach                         | 9.395 mm  | 9.875 mm  |
| G Max. digging reach at ground level         | 9.205 mm  | 9.700 mm  |
| H Min. swing radius                          | 2.700 mm  | 2.310 mm  |
| I Max. height at min. swing radius           | 8.340 mm  | 8.250 mm  |

# Lifting Capacity

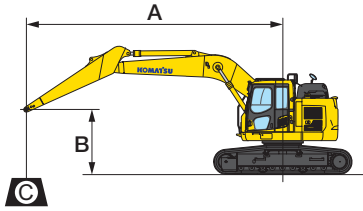

- A – Reach from swing center
- B – Bucket hook height
- C – Lifting capacities

- Rating over front
- Rating over side
- Rating at maximum reach

Weights:

With 2,4 m arm: bucket linkage and bucket cylinder: 360 kg

With 2,9 m arm: bucket linkage and bucket cylinder: 335 kg

With 700 mm shoes

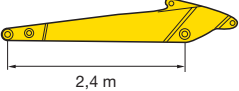
| Arm length   | A      |        |        |       | 7,5 m |       | 6,0 m  |         | 4,5 m   |         | 3,0 m   |         | 1,5 m   |         |
|--|--------|--------|--------|-------|-------|-------|--------|---------|---------|---------|---------|---------|---------|---------|
|  | B      |        |        |       |       |       |        |         |         |         |         |         |         |         |
| <br>2,4 m | 6,0 m  | kg     | *5.155 | 4.275 |       |       | *6.615 | 5.385   |         |         |         |         |         |         |
|  | 4,5 m  | kg     | *5.215 | 3.615 | 5.675 | 3.725 | *7.305 | 5.185   | *8.385  | 7.895   |         |         |         |         |
|  | 3,0 m  | kg     | 5.035  | 3.285 | 5.535 | 3.605 | 7.675  | 4.875   | *11.055 | 7.295   |         |         |         |         |
|  | 1,5 m  | kg     | 4.875  | 3.155 | 5.385 | 3.465 | 7.395  | 4.625   | 11.455  | 6.695   |         |         |         |         |
|  | 0,0 m  | kg     | 4.975  | 3.185 | 5.275 | 3.365 | 7.175  | 4.425   | 11.075  | 6.385   | *8.265  | *8.265  |         |         |
|  | -1,5 m | kg     | 5.405  | 3.435 | 5.255 | 3.345 | 7.085  | 4.345   | 10.985  | 6.305   | *10.565 | *10.565 | *8.975  | *8.975  |
|  | -3,0 m | kg     | 6.495  | 4.055 |       |       | 7.155  | 4.405   | 11.125  | 6.425   | *18.305 | 12.285  | *13.825 | *13.825 |
| -4,5 m   | kg     | *9.715 | 5.885  |       |       |       |        | *10.945 | 6.735   | *15.005 | 12.525  |         |         |         |

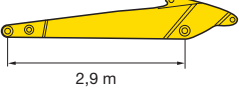
|  |        |       |        |        |        |       |        |         |         |         |         |         |         |         |
|--|--------|-------|--------|--------|--------|-------|--------|---------|---------|---------|---------|---------|---------|---------|
| <br>2,9 m | 6,0 m  | kg    | *3.640 | *3.640 | *3.990 | 3.860 |        |         |         |         |         |         |         |         |
|  | 4,5 m  | kg    | *3.660 | 3.330  | 5.760  | 3.800 | *6.740 | 5.290   |         |         |         |         |         |         |
|  | 3,0 m  | kg    | *3.810 | 3.060  | 5.600  | 3.660 | 7.810  | 4.990   | *10.090 | 7.510   | *14.590 | 14.010  |         |         |
|  | 1,5 m  | kg    | *4.100 | 2.940  | 5.430  | 3.500 | 7.490  | 4.700   | 11.680  | 6.890   | *7.740  | *7.740  |         |         |
|  | 0,0 m  | kg    | 4.590  | 2.960  | 5.300  | 3.380 | 7.230  | 4.480   | 11.200  | 6.490   | *6.080  | *6.080  |         |         |
|  | -1,5 m | kg    | 4.930  | 3.150  | 5.230  | 3.320 | 7.090  | 4.360   | 11.010  | 6.330   | *10.190 | *10.190 | *6.060  | *6.060  |
|  | -3,0 m | kg    | 5.730  | 3.610  |        |       | 7.100  | 4.370   | 11.080  | 6.390   | *17.170 | 12.150  | *10.620 | *10.620 |
| -4,5 m   | kg     | 7.840 | 4.810  |        |        |       |        | *11.300 | 6.600   | *16.750 | 12.550  |         |         |         |

\* Load is limited by hydraulic capacity rather than tipping. Ratings are based on SAE Standard No. J1097. Rated loads do not exceed 87% of hydraulic lift capacity or 75% of tipping load. Lifting capacity stated is based on lifting with bare arm. When lifting with additional equipment installed to the arm, please subtract the weight of all additional equipment from the values stated.

PG228USLG-11



**Notes**

---

---

---

---

---

---

---

---

---

---

---

---

---

---

---

---

---

---

---

---

---

---

---

# Standard and Optional Equipment

## ENGINE

|   |   |
|---|---|
| Komatsu SAA6D107E-3 turbocharged common rail direct injection diesel engine | ● |
| EU Stage IV compliant   | ● |
| Suction type cooling fan with radiator fly screen                           | ● |
| Automatic engine warm-up system   | ● |
| Engine overheat prevention system   | ● |
| Fuel control dial   | ● |
| Auto-deceleration function  | ● |
| Adjustable idle shutdown  | ● |
| Engine key stop   | ● |
| Engine ignition can be password secured on request                          | ● |
| Alternator 24 V/60 A  | ● |
| Starter motor 24 V/5,5 kW   | ● |
| Batteries 2 × 12 V/120 Ah   | ● |

## HYDRAULIC SYSTEM

|  |   |
|--|---|
| Electronic closed-centre load sensing (E-CLSS) hydraulic system (HydrauMind)   | ● |
| Pump and engine mutual control (PEMC) system   | ● |
| 6-working mode selection system; Power mode, Economy mode, Breaker mode, Attachment Power and Attachment Economy mode, and Lifting/Fine Operation mode | ● |
| PowerMax function  | ● |
| PPC wrist control levers for arm, boom, bucket and swing, with sliding proportional control for attachments and 3 auxiliary buttons                    | ● |
| Prepared for hydraulic quick-coupler   | ● |
| Additional hydraulic functions   | ○ |

## DRIVES AND BRAKES

|   |   |
|---|---|
| Hydrostatic, 3-speed travel system with automatic shift and planetary gear type final drives, and hydraulic travel and parking brakes | ● |
| PPC control levers and pedals for steering and travel   | ● |

## UNDERCARRIAGE

|                                  |   |
|----------------------------------|---|
| Track frame under-guards         | ● |
| 600 mm triple grouser shoes      | ● |
| 700, 800 mm triple grouser shoes | ○ |
| 600 mm road-liner (rubber) shoes | ○ |
| Full length track roller guards  | ○ |

## CABIN

|  |   |
|--|---|
| Reinforced safety SpaceCab™; Highly pressurised and tightly sealed hyper viscous mounted cab with tinted safety glass windows, large roof hatch, pull-up type front window with locking device, removable lower window, front window wiper with intermittent feature, cigarette lighter, ashtray, luggage shelf, floor mat | ● |
| Heated, high-back air-suspended seat with lumbar support, console mounted height adjustable arm rests, and retractable seat belt   | ● |
| Automatic climate control system   | ● |
| 12/24 Volt power supplies  | ● |
| Beverage holder  | ● |
| Radio  | ● |
| Auxiliary input (MP3 jack)   | ● |
| Lower wiper  | ○ |
| Rain visor (not with OPG)  | ○ |

## SERVICE AND MAINTENANCE

|  |   |
|--|---|
| Automatic fuel line de-aeration  | ● |
| Double element type air cleaner with dust indicator and auto dust evacuator  | ● |
| KOMTRAX – Komatsu wireless monitoring system (3G)  | ● |
| Komatsu CARE™ – a maintenance program for Komatsu customers  | ● |
| Multifunction video compatible colour monitor with Equipment Management and Monitoring System (EMMS) and efficiency guidance | ● |
| Toolkit  | ● |
| Service points   | ○ |
| Automatic greasing system  | ○ |

## LIGHTING SYSTEM

|  |   |
|--|---|
| Working lights: 2 revolving frame, 1 boom (l.h.)   | ● |
| Additional working lights: 5 cab roof, 1 boom (l.h.), 1 counterweight (rear), additional revolving frame (l.h.), beacon and harness for 2 lamps (not included) in boom foot area | ○ |

## SAFETY EQUIPMENT

|  |   |
|--|---|
| KomVision surround view system               | ● |
| Electric horn                                | ● |
| Overload warning device                      | ● |
| Audible travel alarm                         | ● |
| Boom safety valves                           | ● |
| Large handrails, rear-view mirrors           | ● |
| Battery main switch                          | ● |
| ROPS compliant to ISO 12117-2:2008           | ● |
| Emergency engine stop switch                 | ● |
| Seat belt caution indicator                  | ● |
| Neutral position detection system            | ● |
| Arm safety valve                             | ● |
| OPG Level II front guard (FOPS), hinged type | ○ |
| OPG Level II top guard (FOPS)                | ○ |

## WORK EQUIPMENT

|                                 |   |
|---------------------------------|---|
| Mono boom                       | ● |
| Bucket linkage with lifting eye | ○ |
| 2,4 m; 2,9 m arms               | ○ |
| Komatsu buckets                 | ○ |
| Komatsu breakers                | ○ |

## OTHER EQUIPMENT

|   |   |
|---|---|
| Standard counterweight                                    | ● |
| Remote greasing for swing circle and pins                 | ● |
| Electric refuelling pump with automatic shut-off function | ● |

Further equipment on request

- standard equipment
- optional equipment

Your Komatsu partner:

# KOMATSU

**Komatsu Europe  
International N.V.**

Mechelsesteenweg 586  
B-1800 VILVOORDE (BELGIUM)  
Tel. +32-2-255 24 11  
Fax +32-2-252 19 81  
[www.komatsu.eu](http://www.komatsu.eu)

UENSS18801 03/2019

**KOMATSU** is a trademark of Komatsu Ltd. Japan.

PG228USLG-11