

# KOBELCO

Performance  Design

## SK 140SRLC

- Bucket capacity:  
0.24 – 0.70 m<sup>3</sup>
- Engine power:  
86 kW / 2,200 min<sup>-1</sup>
- Operating weight:  
15,000 – 18,000 kg



Complies with the EU Stage V  
exhaust emission regulation

*Built for Perfectionists™*



SK 140SR<sub>LC</sub>



Performance



Design

SK140SRLC of KOBELCO has realised a completely new value by harmonising PERFORMANCE – greater efficiency and productivity with an increased power and speed and DESIGN – operator-based operability and comfort, refusing to accept any compromises.

In pursuit of unique and matchless machines which are unforgettable once you use them, KOBELCO will continue to rise to meet every challenge.



# THE ULTIMATE IN SIMPLE AND ELEGANT DESIGN

Our pursuit of functional beauty and aesthetic sense produced a new interior design.

## Jog dial

This jog dial integrates multiple functions to realise simple operations. Even with gloved hands, the operator can set various machine conditions without stress.

## LED backlights

The switches and dials have LED backlights – they provide a bright, clear view in the dark and set a luxurious mood.









# UNFORGETTABLE COMFORT

## ① Air suspension seat

A GRAMMER\* seat is installed as standard equipment, which achieves excellent shock absorption and superior ride comfort.

\*GRAMMER is trademark of GRAMMER AG, registered in Germany and other countries.

## ② Air conditioner blowing from the rear

Air is blown against the operator's waist and the back of their head, offering more comfortable operation.

## ③ Lever angles allow for comfortable operations

The operator can move the levers horizontally without twisting their wrist, which reduces the fatigue caused by the operations.



## New hydraulic control

Our newly upgraded hydraulic control system responds to shorter lever strokes than current models, delivering swifter, more precise movement and improved lever operability.

## ④ LED door light

The LED interior light automatically turns on when the door is opened or when the ignition is set to OFF. This ensures easy entry and exit at nighttime.

## ⑤ Parallel wipers secure a wide field of view

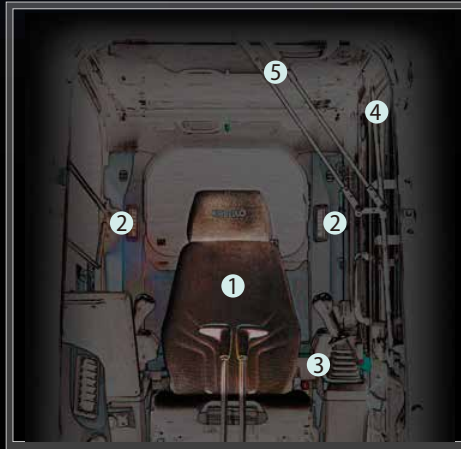



# KOBELCO



04:33



SETTING MENU



PICTURE OF CAMERA



CLOCK SETTING



SCREEN BRIGHTNESS



MAINTENANCE



CONSUMPTION



LANGUAGE SELECTION



PRESSURE RELEASE



# SAFETY ON FULL DISPLAY

## Standard 3 Sides Safety Camera System

Our high-resolution, large display shows right, left and rear side cameras together. Multiple display allows the operator to customize viewing needs to enhance operator awareness and jobsite safety.

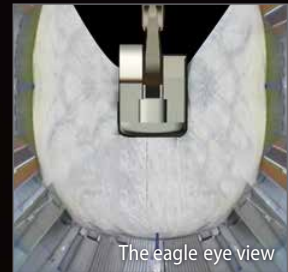
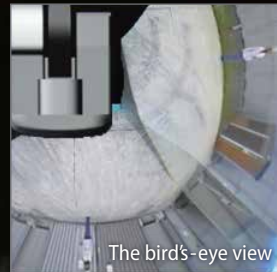
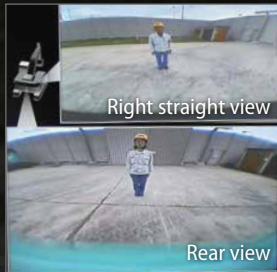

## Large 10-Inch Color Monitor

The easy-to-operate menu screen and recognizable icons assist the operator to select the most important information needed to ensure jobsite safety and machine control.



## Dial in the Right Information

Simply turn the jog dial to the right or left to select an operational feature, then press the dial to confirm selection.







## EXPERIENCING A COMPETENT PERFORMANCE

### Our high-power engine complies with STAGE V emission regulations

Compared to previous models, the engine output is significantly increased, which thereby shortens the digging cycle time remarkably. It attains high performances without reducing the speed even when heavy a load is applied or when travelling on a slope.



Model: ISUZU 4JJ1XDDV A01

Engine output

Increased by **10%**

(Compared to the SK140SRLC-5 model)

▶▶▶ Digging cycle time Shortened by **10%**

(Compared to the SK140SRLC-5 model)





»» Bucket digging force

Increased by **17%**

(Compared to the SK140SRLC-5 model)

»» New hydraulic control

The redesigned hydraulic flow division ensures the right pressure at the right time for faster digging. It contributes to improved cycle time.



# GREATER MULTI-FUNCTION CAPABILITIES



## Attachment mode

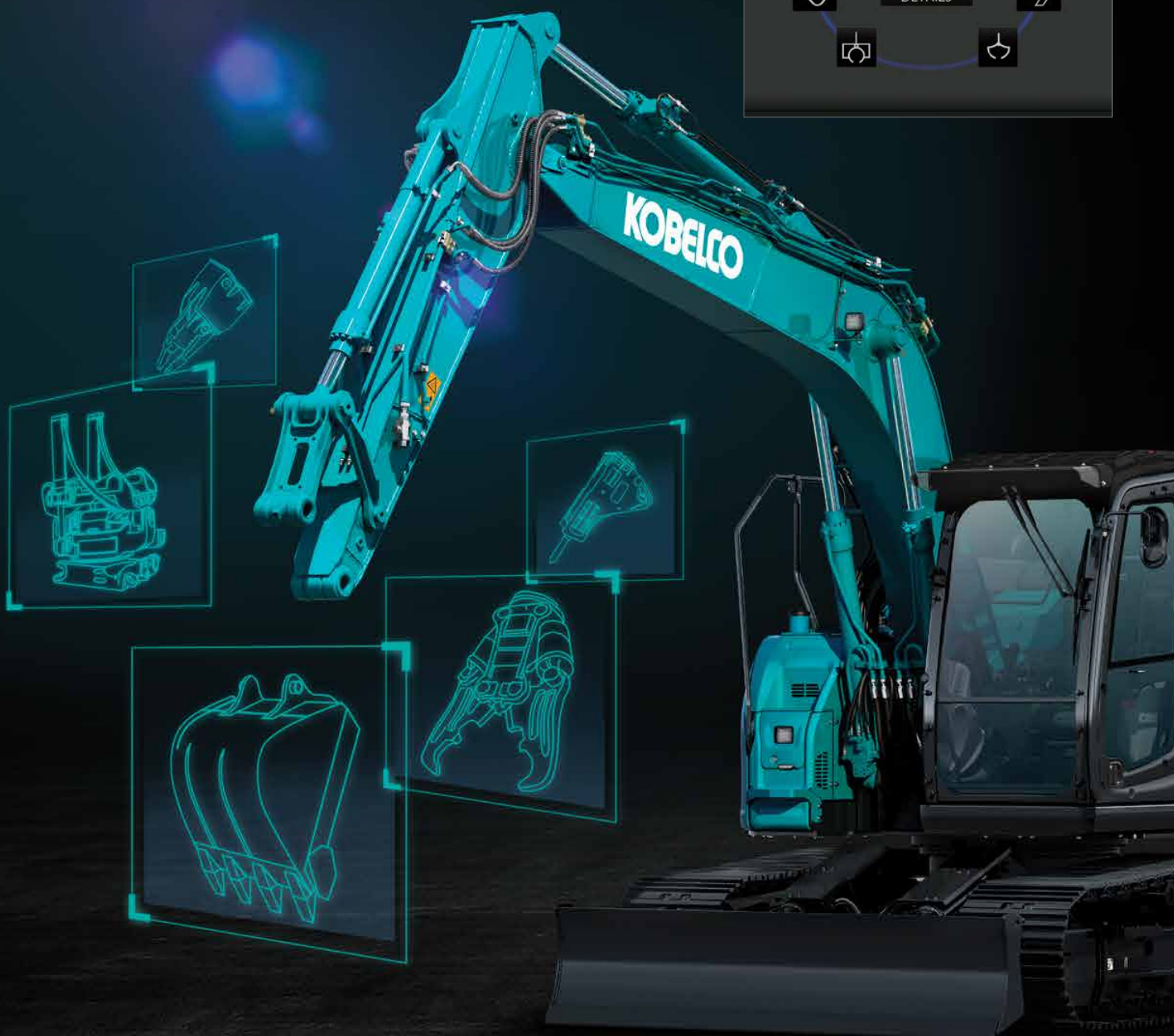



The flow-rate modes of the bucket, breaker, nibbler, and rotating grapple are set before delivery, which allows you to start operating immediately. Mode settings for other attachments, such as the tilt rotator, can easily be added or changed.





## TYPES OF ATTACHMENT MODE

	TYPE	MODE	OBJECTIVE OF MODE
CURRENT MODE		Bucket	Balance in operations such as levelling can be adjusted.
		Breaker	Arm regeneration function considering front attachment weight is provided beforehand.
		Nibbler (crusher)	Change of arm speed due to nibbler (crusher) opening / closing is reduced.

	TYPE	MODE	OBJECTIVE OF MODE
NEWLY ADDED MODE		Rotating grapple	Swing operation on slope while raising attachment/equipment becomes possible. Boom 2-speed systems is controlled by proportional valve.
		Processor	N&B flow rate is set to maximum specifically. Regeneration of arm in operation while using front attachment is changed.
		Thumb bucket	Swing operation while raising attachment/equipment and opening thumb bucket becomes possible.
		Tilt rotator	When combined operation with arm is performed, hydraulic interference is prevented.
		Spare mode for custom setting	This mode should be customized at each field. This is provided for front attachment other than those described above.

### Adjustment for hydraulic flow

Divide ratio of hydraulic flow can be adjusted by service factory for custom usage.





# NON-STOP OPERATION BY iNDr

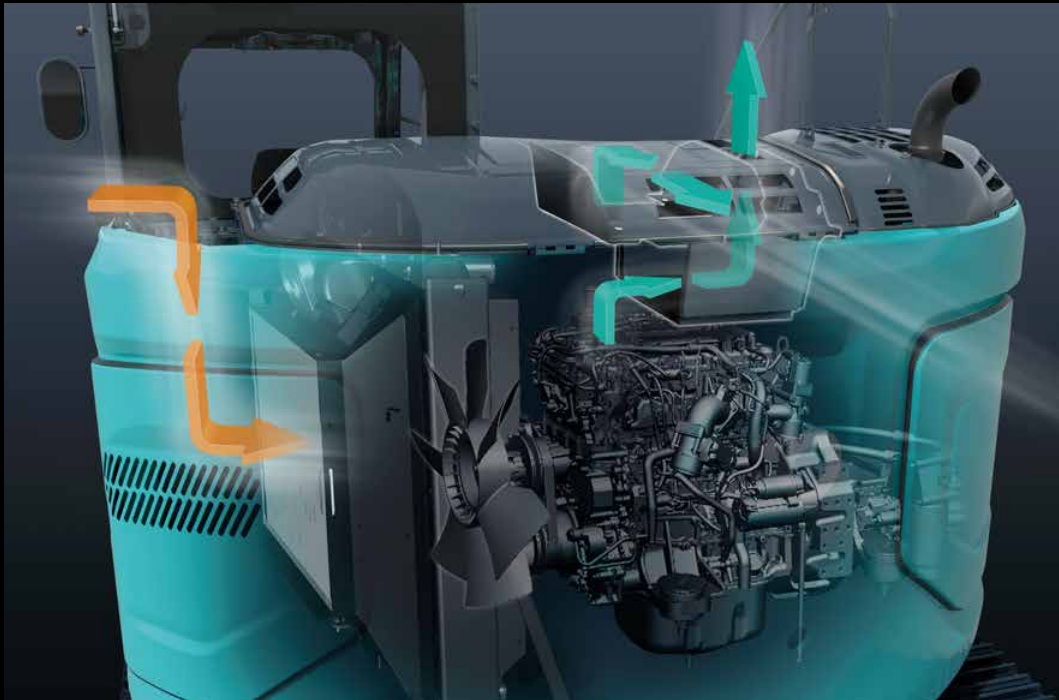

## iNDr Filter

A high-density mesh filter blocks dust intruding during air intake. This prevents the cooling device and the air cleaner from clogging with dust and maintains their performances. The ridges of the corrugated filter allow the air to pass through, and the grooves collect the dust, which prevents the filter from clogging.

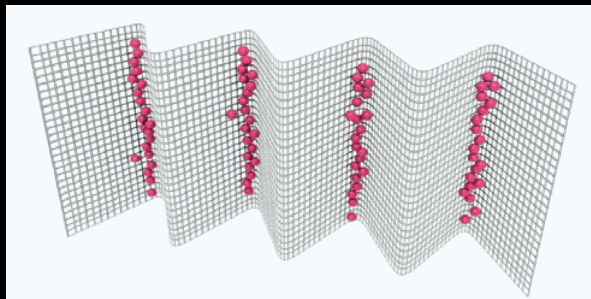

How the filter catches dust

# CONVENIENT AND SENSIBLE EQUIPMENT



## Engine start password

A password is required when starting the engine for greater security. The initial password must be set at our workshop.

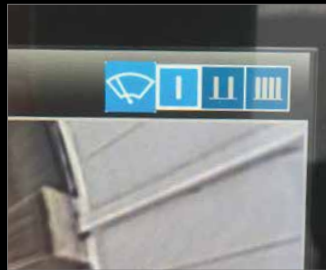

## Wiper adjustment function

In addition to the intermittent wiper mode and continuous wiper mode, the one-time wiper mode was added.



## Parallel wipers/Roll sun shade



## Console mount

The console-integrated seat allows for comfortable operation.



## AM/FM Bluetooth® (hands-free) radio

Bluetooth® is a registered trademark of the Bluetooth SIG Inc.



## USB port/12 V power outlet



## Smartphone holder

You can use the holder with your smartphone connected to the USB port.



## Built-in rear camera/right camera



## Openable FOPS guard

The openable guard allows for easy maintenance.



## Urea tank

Urea filter cap is placed on the step for easy access.

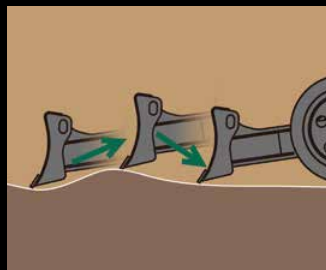

## Floating dozer (Option)

Floating dozer assists in easier leveling work. Floating function can be activated by the switch which is integrated into the dozer control lever.



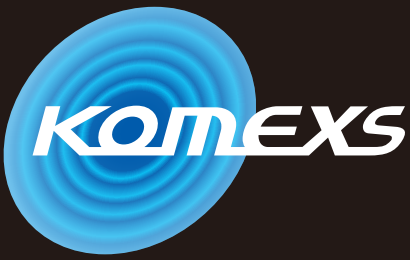

# KOBELCO MONITORING EXCAVATOR SYSTEM



## Remote Monitoring for Peace of Mind

KOMEXS (Kobelco Monitoring Excavator System) uses satellite communication and internet to relay data, and therefore can be deployed in areas where other forms of communication are difficult. When a hydraulic excavator is fitted with this system, data on the machine's operation, such as operating hours, location, fuel consumption, and maintenance status can be obtained remotely.

## Direct Access to Operational Status

### Location Data

Accurate location data can be obtained even from sites where communications are difficult.

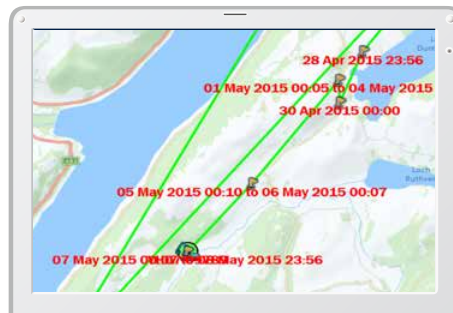
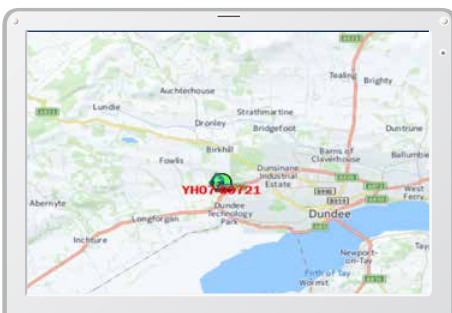

Work data

Period	11 Apr, 2015	to	10 May, 2015	Search
Type of Operation	Working Hrs		Ratio	
Total Working Hrs	169 Hrs		100 %	
Digging Hrs	72.2 Hrs		43 %	
Traveling Hrs	18.3 Hrs		11 %	
Idle Hrs	15.9 Hrs		9 %	
Opt Att Hrs	62.5 Hrs		37 %	
Crane Mode Hrs	0 Hrs		0 %	



## Operating Hours

- A comparison of operating times of machines at multiple locations shows which locations are busier and more profitable.
- Operating hours on site can be accurately recorded, for running time calculations needed for rental machines, etc.

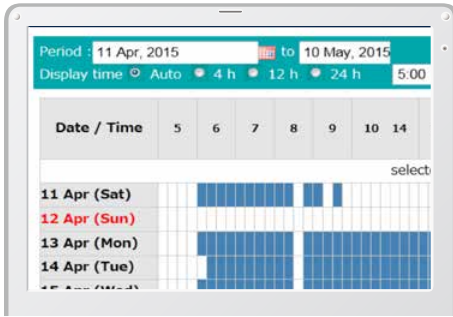

Daily report

## Fuel Consumption Data

Data on fuel consumption and idling times can be used to indicate improvements in fuel consumption.

Work mode	Working Hrs	Total Fuel Consumption
H mode	2:06	24.5 L
S mode	0:00	0.0 L
E mode	169:19	1489.7 L
<b>TOTAL</b>	<b>171:25</b>	<b>1514.2 L</b>

Fuel consumption

## Graph of Work Content

The graph shows how working hours are divided among different operating categories, including digging, idling, travelling and optional operations.

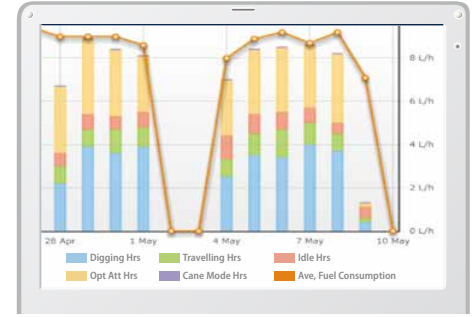

Work status

## Maintenance Data and Warning Alerts

### Machine Maintenance Data

- Provides maintenance status of separate machines operating at multiple sites.
- Maintenance data is also relayed to KOBELCO service personnel, for more efficient planning of periodic servicing.

Model	Serial No.	Hour Meter	Engine Oil
SK135SRLC-3/SK140SRL	<a href="#">YH07-09721</a>	734 Hr	434
SK135SRLC-3/SK140SRL	<a href="#">YH07-09789</a>	73 Hr	429
SK210LC-9	<a href="#">YQ13-10454</a>	960 Hr	58
SK210LC-9	<a href="#">YQ13-10481</a>	549 Hr	498
SK75SR-	<a href="#">YT08-30374</a>		

Maintenance

### Warning Alerts

This system warns an alert if an anomaly is sensed, preventing damage that could result in machine downtime.

## Alarm Information Can Be Received through E-mail

Alarm information or maintenance notice can be received through E-mail, using a computer or cell phone.



Alarm messages can be received on mobile device.

## Daily/Monthly Reports

Operational data downloaded onto a computer helps in formulating daily and monthly reports.

## Security System

### Engine Start Alarm

The system can be set an alarm if the machine is operated outside designated time.

Engine start alarm outside prescribed work time

### Area Alarm

It can be set an alarm if the machine is moved out of its designated area to another location.

Alarm for outside of reset area

# Specifications



## Engine

Model	ISUZU MOTORS LIMITED 4JJ1XDDV A01
Type	Four-cycle, liquid-cooled, direct injection diesel, turbo charged complies with EU Stage V exhaust emission regulation
No. of cylinders	4
Bore and stroke	95.4 mm x 104.9 mm
Displacement	2.999 L
Rated power output	78.6 kW/2,200 min <sup>-1</sup> (ISO 9249: with fan)
	86 kW/2,200 min <sup>-1</sup> (ISO 14396: without fan)
Max. torque	354 N-m/1,800 min <sup>-1</sup> (ISO 9249: with fan)
	375 N-m/1,800 min <sup>-1</sup> (ISO 14396: without fan)



## Hydraulic system

Pump	
Type	Two variable displacement piston pumps + one gear pump
Max. discharge flow	2 x 142 L/min 1 x 66 L/min
Relief valve setting	
Boom, arm and bucket	34.3 MPa
Travel circuit	34.3 MPa
Swing circuit	28.0 MPa
Control circuit	5.0 MPa
Pilot control pump	Gear type
Main control valves	12-spool
Oil cooler	Air cooled type



## Swing system

Swing motor	One fixed displacement piston motor
Brake	Hydraulic; locking automatically when the swing control lever is in the neutral position
Parking brake	Wet multiple plate
Swing speed	11.0 min <sup>-1</sup>
Tail swing radius	1,490 mm
Swing torque	40.4 kN-m



## Attachments

Backhoe bucket and combination.

Use		Backhoe bucket							
		Normal digging							
Bucket capacity	ISO heaped	m <sup>3</sup>	0.24	0.31	0.38	0.45	0.50	0.57	0.70
	Struck	m <sup>3</sup>	0.20	0.23	0.28	0.35	0.38	0.43	0.52
Opening width	With side cutter	mm	590	700	800	915	1,000	1,100	1,275
	Without side cutter	mm	500	640	740	855	940	1,040	1,180
No. of teeth			3	3	4	4	5	5	5
Bucket weight		kg	280	300	340	360	390	410	440
Combination	2.38 m arm		○	○	○	○	◎	△	△
	2.84 m arm		○	○	◎	△	×	×	×

◎ Standard ○ Recommended △ Loading only × Not recommended



## Travel system

Travel motors	Variable displacement piston, two-speed motors
Travel brakes	Hydraulic brake
Parking brakes	Wet multiple plate
Travel shoes	46 each side
Travel speed	3.4/5.6 km/h
Drawbar pulling force	140 kN (SAE)
Gradeability	70% {35°}



## Cab & control

Cab	
All-weather, sound-suppressed steel cab mounted on the silicon-sealed viscous mounts and equipped with a heavy, insulated floor mat	
Control	
Two hand levers and two foot pedals for travel	
Two hand levers for excavating and swing	
Electric rotary-type engine throttle	
Noise levels	
External	99 dB(A)
Operator	74 dB(A)



## Boom, arm & bucket

Boom cylinders	100 mm x 1,092 mm
Arm cylinder	115 mm x 1,116 mm
Bucket cylinder	100 mm x 903 mm



## Refilling capacities & lubrications

Fuel tank	186 L
Cooling system	17 L
Engine oil	17 L
Travel reduction gear	2 x 2.1 L
Swing reduction gear	1.65 L
Hydraulic oil tank	89.9 L tank oil level
	182 L hydraulic system
DEF/Urea tank	20.7 L



## Working ranges

Unit: m

Boom		4.68 m	
Range	Arm	2.38 m	2.84 m
a- Max. digging reach		8.37	8.81
b- Max. digging reach at ground level		8.21	8.66
c- Max. digging depth		5.51	5.97
d- Max. digging height		9.19	9.56
e- Max. dumping clearance		6.76	7.12
f- Min. dumping clearance		2.63	2.26
g- Max. vertical wall digging depth		4.49	4.94
h- Min. swing radius		2.13	2.52
i- Horizontal digging stroke at ground level		4.19	4.68
j- Digging depth for 2.4 m (8') flat bottom		5.28	5.77
Bucket capacity ISO heaped m <sup>3</sup>		0.50	0.38

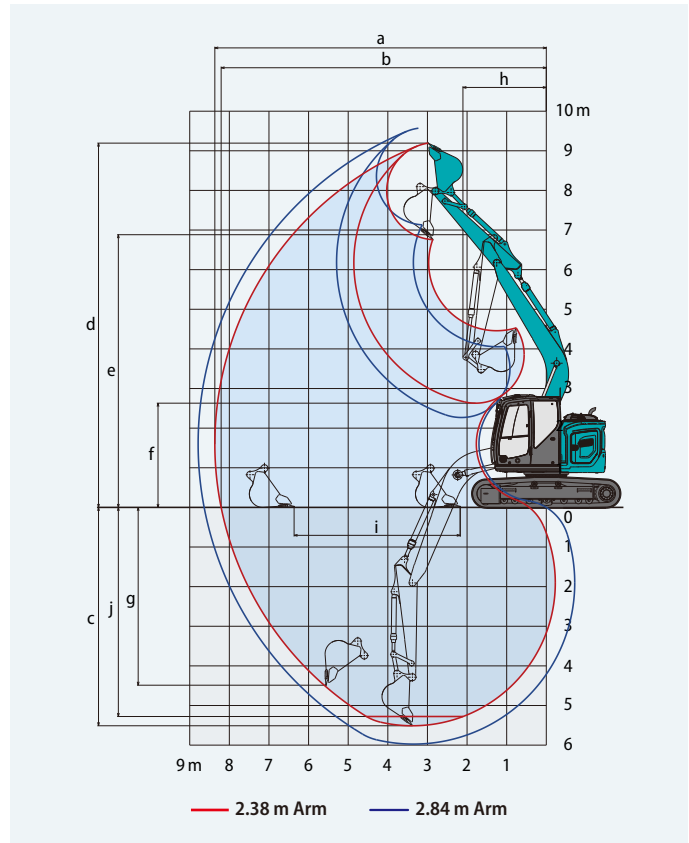

## Digging force (ISO 6015)

Unit: kN

Arm length	2.38 m	2.84 m
Bucket digging force	105.4	
Arm crowding force	64.0	58.0



## Dimensions

Unit: mm

Arm length	2.38 m	2.84 m
A Overall length	7,530	7,550
B Overall height (to top of boom)	2,790	3,140
C Overall width (600 mm shoe)	2,590	
D Overall height (to top of cab)	2,870	
E Ground clearance of rear end*	880	
F Ground clearance* {with dozer}	425 {410}	

G Tail swing radius {additional counterweight}	1,490 {1,610**/1,670***}
G' Distance from centre of swing to rear end {additional counterweight}	1,490 {1,610**/1,670***}
H Tumbler distance	3,040
I Overall length of crawler	3,780
J Track gauge	1,990
K Shoe width	600
L Overall width of upperstructure	2,480

\*Without including height of shoe lug \*\*580 kg counterweight \*\*\*1,000 kg counterweight

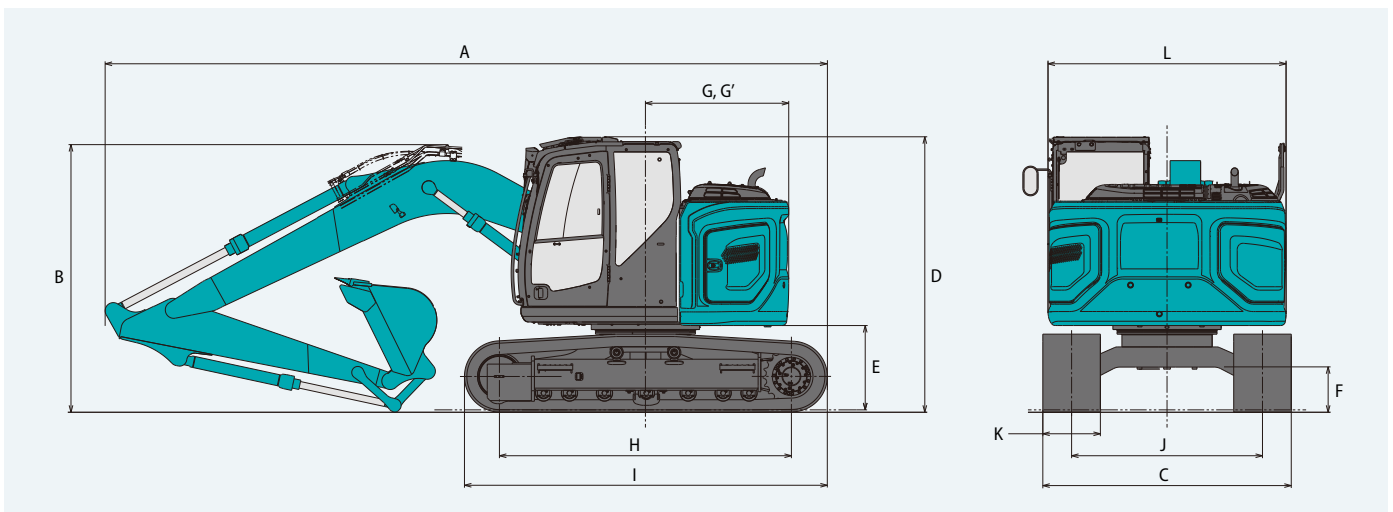



# Operating weight & ground pressure

## Standard boom

Boom: 4.68 m Arm: 2.38 m Bucket: 0.5 m<sup>3</sup> ISO heaped bucket Dozer: without

	HD shoes				BS Geogrip shoes	Rubber pad shoes
Shoes (mm)	500	600	700	800	500	500
Counterweight	standard					
Ground pressure (kPa)	45.1	38.2	33.2	29.5	44.4	45.2
Operating weight (kg)	15,200	15,400	15,600	15,900	15,000	15,300

	HD shoes							
Shoes (mm)	500	600	700	800	500	600	700	800
Counterweight	+ 580 kg				+ 1,000 kg			
Ground pressure (kPa)	46.8	39.6	34.5	30.6	48.1	40.7	35.4	31.3
Operating weight (kg)	15,700	16,000	16,200	16,400	16,200	16,400	16,600	16,900

Boom: 4.68 m Arm: 2.38 m Bucket: 0.5 m<sup>3</sup> ISO heaped bucket Dozer: with

	HD shoes			BS Geogrip shoes	Rubber pad shoes
Shoes (mm)	500	600	700	500	500
Dozer (mm)	2,490	2,590	2,690	2,490	2,490
Counterweight	standard				
Ground pressure (kPa)	47.5	40.2	35.0	46.8	47.5
Operating weight (kg)	16,000	16,200	16,500	15,800	16,100

	HD shoes					
Shoes (mm)	500	600	700	500	600	700
Dozer (mm)	2,490	2,590	2,690	2,490	2,590	2,690
Counterweight	+ 580 kg			+ 1,000 kg		
Ground pressure (kPa)	49.2	41.6	36.2	50.4	42.7	37.1
Operating weight (kg)	16,500	16,800	17,000	17,000	17,200	17,500

Boom: 4.68 m Arm: 2.84 m Bucket: 0.38 m<sup>3</sup> ISO heaped bucket Dozer: without

	HD shoes				BS Geogrip shoes	Rubber pad shoes
Shoes (mm)	500	600	700	800	500	500
Counterweight	standard					
Ground pressure (kPa)	45.1	38.2	33.2	29.5	44.4	45.1
Operating weight (kg)	15,100	15,400	15,600	15,900	15,000	15,300

	HD shoes							
Shoes (mm)	500	600	700	800	500	600	700	800
Counterweight	+ 580 kg				+ 1,000 kg			
Ground pressure (kPa)	46.8	39.6	34.5	30.6	48.0	40.6	35.3	31.3
Operating weight (kg)	15,700	16,000	16,200	16,400	16,200	16,400	16,600	16,900

Boom: 4.68 m Arm: 2.84 m Bucket: 0.38 m<sup>3</sup> ISO heaped bucket Dozer: with

	HD shoes			BS Geogrip shoes	Rubber pad shoes
Shoes (mm)	500	600	700	500	500
Dozer (mm)	2,490	2,590	2,690	2,490	2,490
Counterweight	standard				
Ground pressure (kPa)	47.4	40.2	35.0	46.7	47.5
Operating weight (kg)	15,900	16,200	16,500	15,800	16,100

	HD shoes					
Shoes (mm)	500	600	700	500	600	700
Dozer (mm)	2,490	2,590	2,690	2,490	2,590	2,690
Counterweight	+ 580 kg			+ 1,000 kg		
Ground pressure (kPa)	49.2	41.6	36.2	50.4	42.7	37.1
Operating weight (kg)	16,500	16,800	17,000	17,000	17,200	17,500

# Two-piece boom specifications

**SK140SR<sub>LC</sub>**  
SK140SR<sub>LC</sub>-7

## Working ranges

Unit: m

Boom	Two-piece boom	
Range	2.38 m	2.84 m
a- Max. digging reach	8.83	9.27
b- Max. digging reach at ground level	8.68	9.12
c- Max. digging depth	5.69	6.15
d- Max. digging height	9.53	9.88
e- Max. dumping clearance	7.11	7.46
f- Min. dumping clearance	0.93	0.47
g- Max. vertical wall digging depth	4.63	5.10
h- Min. swing radius	2.18	2.55
i- Horizontal digging stroke at ground level	5.70	6.59
j- Digging depth for 2.4 m (8') flat bottom	5.57	6.04
Bucket capacity ISO heaped m <sup>3</sup>	0.50	0.38

## Digging force (ISO 6015)

Unit: kN

Arm length	2.38 m	2.84 m
Bucket digging force	105.4	
Arm crowding force	64.0	58.0

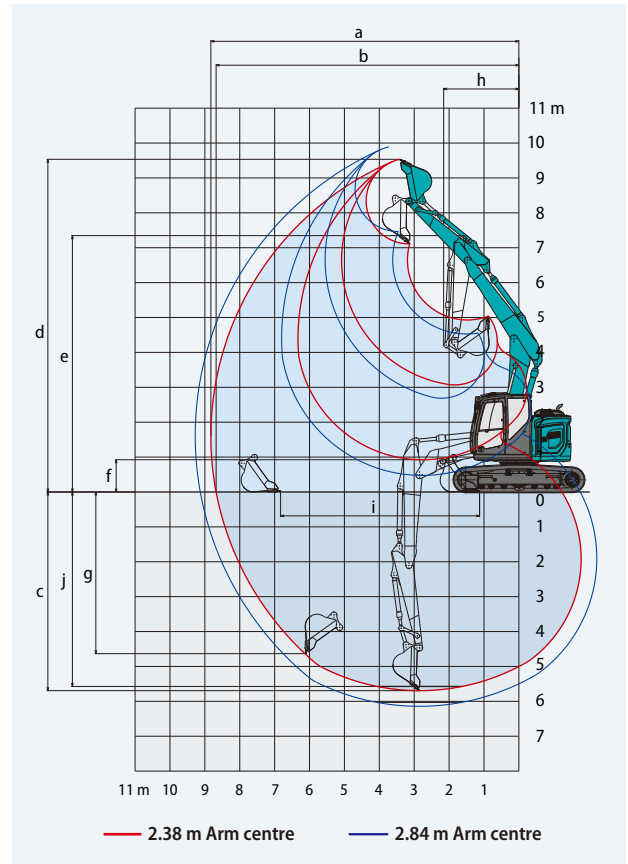

## Dimensions

Unit: mm

Arm length	2.38 m	2.84 m
A Overall length	8,020	8,080
B Overall height (to top of boom)	2,770	3,090
C Overall width (600 mm shoe)	2,590	
D Overall height (to top of cab)	2,870	
E Ground clearance of rear end*	880	
F Ground clearance*	410	

G Tail swing radius {additional counterweight}	1,490 {1,610**/1,670***}
G' Distance from centre of swing to rear end {additional counterweight}	1,490 {1,610**/1,670***}
H Tumbler distance	3,040
I Overall length of crawler	3,780
J Track gauge	1,990
K Shoe width	600
L Overall width of upperstructure	2,480
M Dozer blade (up/down)	515/575

\*Without including height of shoe lug \*\*580 kg counterweight \*\*\*1,000 kg counterweight

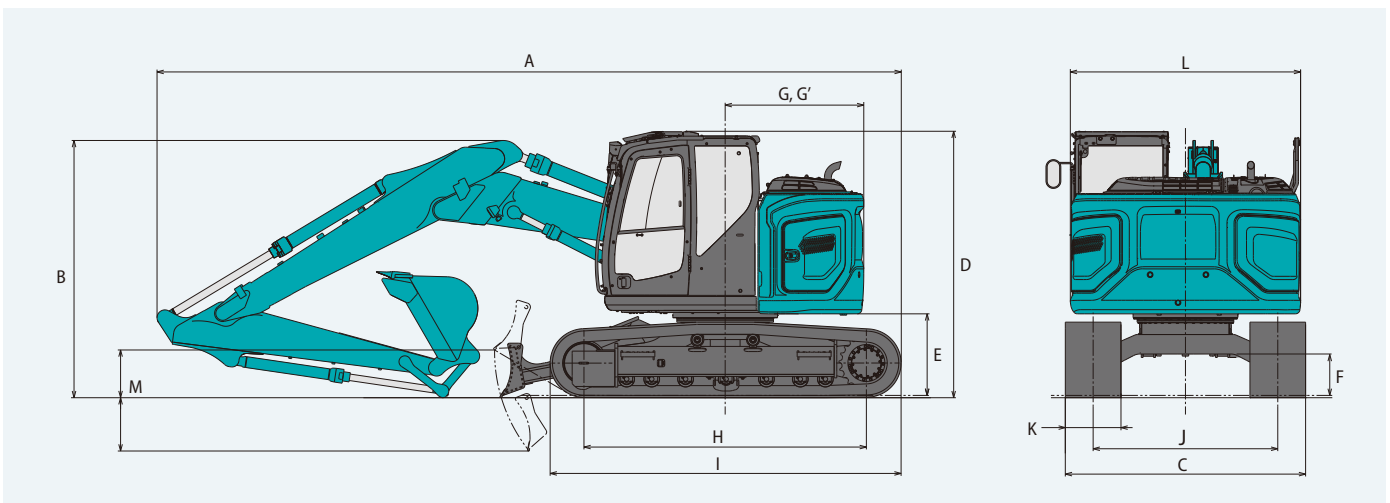

# Offset boom specifications



## Working ranges

Unit: m

Boom	Arm	Offset boom					
		2.20 m			2.50 m		
Range		Max. left	Centre	Max. right	Max. left	Centre	Max. right
a- Max. digging reach		7.18	7.60	7.16	7.44	7.86	7.42
b- Max. digging reach at ground level		6.99	7.42	6.98	7.26	7.69	7.24
c- Max. digging depth		4.52	4.92	4.50	4.81	5.22	4.80
d- Max. digging height		7.75	8.09	7.74	7.91	8.25	7.90
e- Max. dumping clearance		5.43	5.77	5.42	5.59	5.93	5.58
f- Min. dumping clearance		2.11	2.44	2.10	1.82	2.15	1.81
g- Max. vertical wall digging depth		2.62	2.94	2.61	2.90	3.23	2.89
h- Min. swing radius		1.88	1.83	2.13	1.93	1.87	2.19
i- Horizontal digging stroke at ground level		3.78	3.76	3.78	4.25	4.22	4.25
j- Digging depth for 2.4 m (8') flat bottom		4.15	4.55	4.13	4.47	4.87	4.45
Bucket capacity ISO heaped m <sup>3</sup>		0.45	0.45	0.45	0.38	0.38	0.38

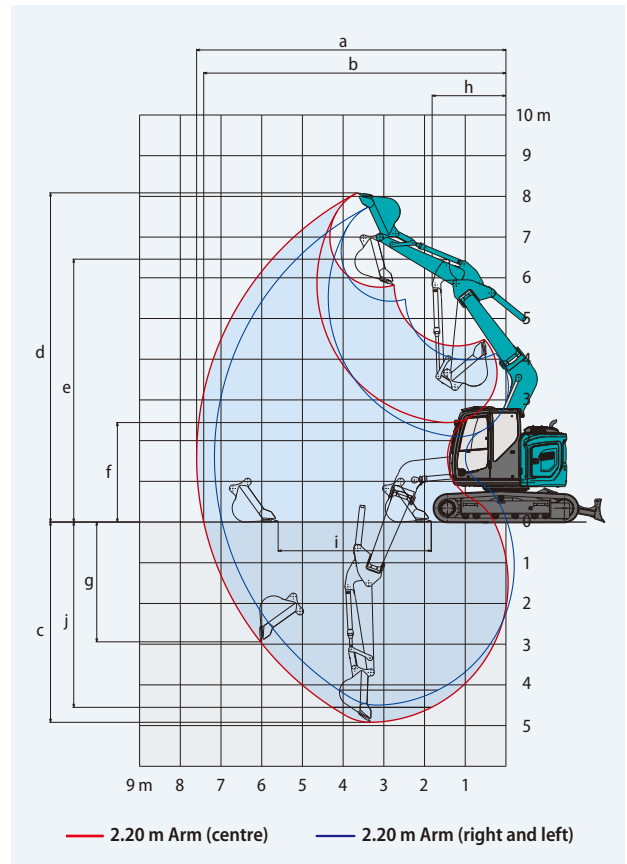

## Digging force (ISO 6015)

Unit: kN

Arm length	2.20 m	2.50 m
Bucket digging force	92.9	
Arm crowding force	61.9	57.3



## Dimensions

Unit: mm

Arm length	2.20 m	2.50 m
A Overall length	7,550	7,570
B Overall height (to top of boom)	2,730	2,750
C Overall width (600 mm shoe)	2,590	
D Overall height (to top of cab)	2,870	
E Ground clearance of rear end*	880	
F Ground clearance*	410	
G Tail swing radius {additional counterweight}	1,490 {1,610**/1,670***}	

G'	Distance from centre of swing to rear end {additional counterweight}	1,490 {1,610**/1,670***}
H	Tumbler distance	3,040
I	Overall length of crawler	3,780
J	Track gauge	1,990
K	Shoe width	600
L	Overall width of upperstructure	2,480
M	Dozer blade (up/down)	515/575

\*Without including height of shoe lug \*\*580 kg counterweight \*\*\*1,000 kg counterweight

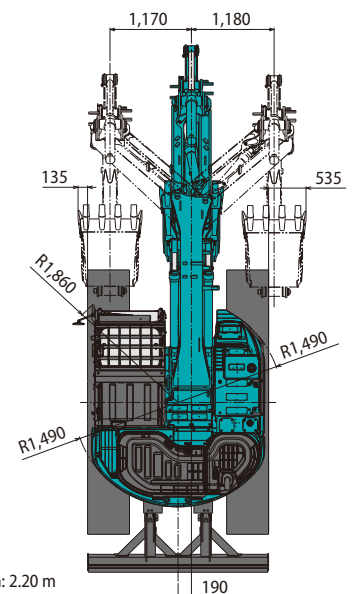
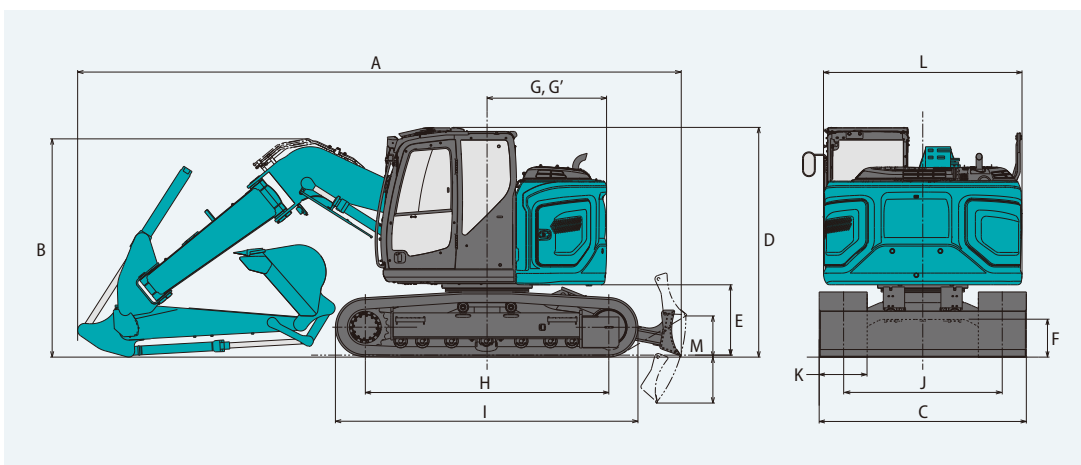

Arm length: 2.20 m



# Operating weight & ground pressure

## Two-piece boom

Boom: Two-piece Arm: 2.38 m Bucket: 0.5 m<sup>3</sup> ISO heaped bucket Dozer: without

	HD shoes				BS Geogrip shoes	Rubber pad shoes
Shoes (mm)	500	600	700	800	500	500
Counterweight	standard					
Ground pressure (kPa)	47.1	39.9	34.7	30.8	46.4	47.2
Operating weight (kg)	15,900	16,100	16,300	16,600	15,700	16,000

	HD shoes				BS Geogrip shoes	Rubber pad shoes	HD shoes				BS Geogrip shoes	Rubber pad shoes
Shoes (mm)	500	600	700	800	500	500	500	600	700	800	500	500
Counterweight	+ 580 kg						+ 1,000 kg					
Ground pressure (kPa)	48.9	41.4	35.9	31.9	48.2	48.9	50.1	42.4	36.8	32.6	49.4	50.2
Operating weight (kg)	16,400	16,700	16,900	17,100	16,300	16,600	16,900	17,100	17,300	17,600	16,700	17,000

Boom: Two-piece Arm: 2.38 m Bucket: 0.5 m<sup>3</sup> ISO heaped bucket Dozer: with

	HD shoes			BS Geogrip shoes	Rubber pad shoes	BS Geogrip shoes	Rubber pad shoes
Shoes (mm)	500	600	700	500	500	500	500
Dozer (mm)	2,490	2,590	2,690	2,490	2,490	2,490	2,490
Counterweight	standard						
Ground pressure (kPa)	49.5	41.9	36.5	48.8	49.6		
Operating weight (kg)	16,700	16,900	17,200	16,500	16,800		

	HD shoes				BS Geogrip shoes	Rubber pad shoes	HD shoes				BS Geogrip shoes	Rubber pad shoes
Shoes (mm)	500	600	700	800	500	500	500	600	700	800	500	500
Dozer (mm)	2,490	2,590	2,690	2,490	2,490	2,490	2,490	2,590	2,690	2,490	2,490	2,490
Counterweight	+ 580 kg						+ 1,000 kg					
Ground pressure (kPa)	51.3	43.4	37.7	50.6	51.3	52.5	44.4	38.6	51.8	52.5		
Operating weight (kg)	17,200	17,500	17,700	17,100	17,400	17,700	17,900	18,200	17,500	17,800		

Boom: Two-piece Arm: 2.84 m Bucket: 0.38 m<sup>3</sup> ISO heaped bucket Dozer: without

	HD shoes				BS Geogrip shoes	Rubber pad shoes
Shoes (mm)	500	600	700	800	500	500
Counterweight	standard					
Ground pressure (kPa)	47.1	39.9	34.7	30.8	46.4	47.2
Operating weight (kg)	15,800	16,100	16,300	16,600	15,700	16,000

	HD shoes				BS Geogrip shoes	Rubber pad shoes	HD shoes				BS Geogrip shoes	Rubber pad shoes
Shoes (mm)	500	600	700	800	500	500	500	600	700	800	500	500
Counterweight	+ 580 kg						+ 1,000 kg					
Ground pressure (kPa)	48.9	41.4	35.9	31.9	48.2	48.9	50.1	42.4	36.8	32.6	49.4	50.2
Operating weight (kg)	16,400	16,700	16,900	17,100	16,300	16,600	16,800	17,100	17,300	17,600	16,700	17,000

Boom: Two-piece Arm: 2.84 m Bucket: 0.38 m<sup>3</sup> ISO heaped bucket Dozer: with

	HD shoes			BS Geogrip shoes	Rubber pad shoes	BS Geogrip shoes	Rubber pad shoes
Shoes (mm)	500	600	700	500	500	500	500
Dozer (mm)	2,490	2,590	2,690	2,490	2,490	2,490	2,490
Counterweight	standard						
Ground pressure (kPa)	49.5	41.9	36.4	48.8	49.6		
Operating weight (kg)	16,600	16,900	17,200	16,500	16,800		

	HD shoes				BS Geogrip shoes	Rubber pad shoes	HD shoes				BS Geogrip shoes	Rubber pad shoes
Shoes (mm)	500	600	700	800	500	500	500	600	700	800	500	500
Dozer (mm)	2,490	2,590	2,690	2,490	2,490	2,490	2,490	2,590	2,690	2,490	2,490	2,490
Counterweight	+ 580 kg						+ 1,000 kg					
Ground pressure (kPa)	51.3	43.4	37.7	50.5	51.3	52.5	44.4	38.6	51.8	52.5		
Operating weight (kg)	17,200	17,500	17,700	17,100	17,400	17,700	17,900	18,200	17,500	17,800		

# Operating weight & ground pressure

## Offset boom

Boom: Offset Arm: 2.20 m Bucket: 0.45 m<sup>3</sup> ISO heaped bucket Dozer: with

	HD shoes			BS Geogrip shoes	Rubber pad shoes
Shoes (mm)	500	600	700	500	500
Dozer (mm)	2,490	2,590	2,690	2,490	2,490
Counterweight	standard				
Ground pressure (kPa)	49.0	41.4	36.0	48.3	49.0
Operating weight (kg)	16,500	16,700	17,000	16,300	16,600

	HD shoes			BS Geogrip shoes	Rubber pad shoes	HD shoes			BS Geogrip shoes	Rubber pad shoes
Shoes (mm)	500	600	700	500	500	500	600	700	500	500
Dozer (mm)	2,490	2,590	2,690	2,490	2,490	2,490	2,590	2,690	2,490	2,490
Counterweight	+ 580 kg					+ 1,000 kg				
Ground pressure (kPa)	50.7	42.9	37.3	50.0	50.7	51.9	43.9	38.2	51.2	52.0
Operating weight (kg)	17,000	17,300	17,600	16,900	17,200	17,500	17,700	18,000	17,300	17,600

Boom: Offset Arm: 2.50 m Bucket: 0.38 m<sup>3</sup> ISO heaped bucket Dozer: with

	HD shoes			BS Geogrip shoes	Rubber pad shoes
Shoes (mm)	500	600	700	500	500
Dozer (mm)	2,490	2,590	2,690	2,490	2,490
Counterweight	standard				
Ground pressure (kPa)	49.1	41.5	36.1	48.4	49.1
Operating weight (kg)	16,500	16,800	17,000	16,300	16,600

	HD shoes			BS Geogrip shoes	Rubber pad shoes	HD shoes			BS Geogrip shoes	Rubber pad shoes
Shoes (mm)	500	600	700	500	500	500	600	700	500	500
Dozer (mm)	2,490	2,590	2,690	2,490	2,490	2,490	2,590	2,690	2,490	2,490
Counterweight	+ 580 kg					+ 1,000 kg				
Ground pressure (kPa)	50.8	43.0	37.4	50.1	50.9	52.0	44.0	38.3	51.3	52.1
Operating weight (kg)	17,100	17,300	17,600	16,900	17,200	17,500	17,800	18,000	17,300	17,600

# Lift capacities

## SK140SR<sub>LC</sub>

## SK140SR<sub>LC</sub> Offset Boom

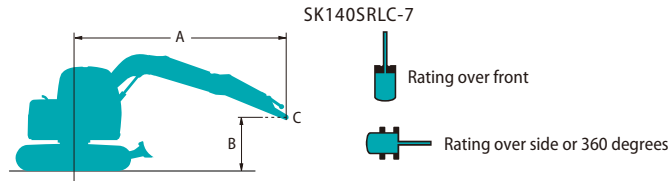

A - Reach from swing centreline to arm top  
 B - Arm top height above/below ground  
 C - Lift point  
 Relief valve setting: 34.3 MPa

SK140SR <sub>LC</sub>		Boom: 4.68 m Arm: 2.38 m Bucket: without Counterweight: 3,150 kg Shoe: 600 mm Dozer: blade up										
A \ B		1.5 m		3.0 m		4.5 m		6.0 m		At max. reach		Radius
7.5 m	kg									*2,270	*2,270	3.82 m
6.0 m	kg					*3,390	*3,390			*1,800	*1,800	5.56 m
4.5 m	kg			*4,300	*4,300	*3,670	*3,670	*3,380	2,410	*1,670	*1,670	6.50 m
3.0 m	kg			*6,560	*6,560	*4,430	3,590	3,620	2,320	*1,670	*1,670	7.00 m
1.5 m	kg			*5,220	*5,220	*5,250	3,310	3,490	2,210	*1,760	1,700	7.13 m
G.L.	kg			*6,040	5,660	5,220	3,140	3,400	2,120	*1,980	1,730	6.94 m
-1.5 m	kg	*5,330	*5,330	*8,040	5,670	5,160	3,090	3,370	2,100	*2,440	1,940	6.38 m
-3.0 m	kg	*9,110	*9,110	*6,420	5,810	*4,440	3,160			*3,370	2,520	5.35 m

SK140SR <sub>LC</sub>		Boom: 4.68 m Arm: 2.38 m Bucket: without Counterweight: 3,150 kg + 580 kg Shoe: 600 mm Dozer: blade up										
A \ B		1.5 m		3.0 m		4.5 m		6.0 m		At max. reach		Radius
7.5 m	kg									*2,270	*2,270	3.82 m
6.0 m	kg					*3,390	*3,390			*1,800	*1,800	5.56 m
4.5 m	kg			*4,300	*4,300	*3,670	*3,670	*3,380	2,630	*1,670	*1,670	6.50 m
3.0 m	kg			*6,560	*6,560	*4,430	3,910	*3,630	2,550	*1,670	*1,670	7.00 m
1.5 m	kg			*5,220	*5,220	*5,250	3,640	3,790	2,430	*1,760	*1,760	7.13 m
G.L.	kg			*6,040	*6,040	*5,650	3,460	3,690	2,340	*1,980	1,920	6.94 m
-1.5 m	kg	*5,330	*5,330	*8,040	6,250	*5,450	3,410	3,670	2,320	*2,440	2,150	6.38 m
-3.0 m	kg	*9,110	*9,110	*6,420	6,390	*4,440	3,480			*3,370	2,780	5.35 m

SK140SR <sub>LC</sub>		Boom: 4.68 m Arm: 2.38 m Bucket: without Counterweight: 3,150 kg + 1,000 kg Shoe: 600 mm Dozer: blade up										
A \ B		1.5 m		3.0 m		4.5 m		6.0 m		At max. reach		Radius
7.5 m	kg									*2,270	*2,270	3.82 m
6.0 m	kg					*3,390	*3,390			*1,800	*1,800	5.56 m
4.5 m	kg			*4,300	*4,300	*3,670	*3,670	*3,380	2,800	*1,670	*1,670	6.50 m
3.0 m	kg			*6,560	*6,560	*4,430	4,150	*3,630	2,710	*1,670	*1,670	7.00 m
1.5 m	kg			*5,220	*5,220	*5,250	3,870	*3,950	2,600	*1,760	*1,760	7.13 m
G.L.	kg			*6,040	*6,040	*5,650	3,700	3,910	2,510	*1,980	*1,980	6.94 m
-1.5 m	kg	*5,330	*5,330	*8,040	6,670	*5,450	3,650	*3,880	2,490	*2,440	2,300	6.38 m
-3.0 m	kg	*9,110	*9,110	*6,420	*6,420	*4,440	3,720			*3,370	2,970	5.35 m

SK140SR <sub>LC</sub>		Boom: 4.68 m Arm: 2.84 m Bucket: without Counterweight: 3,150 kg Shoe: 600 mm Dozer: blade up												
A \ B		1.5 m		3.0 m		4.5 m		6.0 m		7.5 m		At max. reach		Radius
7.5 m	kg					*2,360	*2,360					*2,050	*2,050	4.61 m
6.0 m	kg					*2,960	*2,960	*2,110	*2,110			*1,700	*1,700	6.12 m
4.5 m	kg					*3,280	*3,280	*3,090	2,440			*1,590	*1,590	6.99 m
3.0 m	kg			*5,680	*5,680	*4,060	3,650	*3,400	2,340			*1,590	*1,590	7.45 m
1.5 m	kg			*7,740	6,030	*4,970	3,350	3,500	2,210	*2,080	1,570	*1,670	1,540	7.58 m
G.L.	kg			*6,220	5,650	5,220	3,130	3,380	2,100			*1,850	1,560	7.40 m
-1.5 m	kg	*4,560	*4,560	*8,400	5,590	5,120	3,050	3,330	2,050			*2,210	1,710	6.88 m
-3.0 m	kg	*7,660	*7,660	*7,080	5,690	*4,820	3,080					*3,040	2,130	5.93 m
-4.5 m	kg			*4,330	*4,330							*2,760	*2,760	4.26 m



# Lift capacities

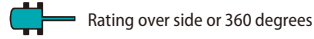
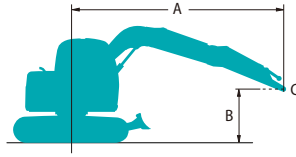

A - Reach from swing centreline to arm top

B - Arm top height above/below ground

C - Lift point

Relief valve setting: 34.3 MPa

SK140SRLC		Boom: 4.68 m		Arm: 2.84 m		Bucket: without		Counterweight: 3,150 kg + 580 kg		Shoe: 600 mm		Dozer: blade up		Radius
B \ A		1.5 m		3.0 m		4.5 m		6.0 m		7.5 m		At max. reach		
7.5 m	kg					*2,360	*2,360					*2,050	*2,050	4.61 m
6.0 m	kg					*2,960	*2,960	*2,110	*2,110			*1,700	*1,700	6.12 m
4.5 m	kg					*3,280	*3,280	*3,090	2,670			*1,590	*1,590	6.99 m
3.0 m	kg			*5,680	*5,680	*4,060	3,980	*3,400	2,560			*1,590	*1,590	7.45 m
1.5 m	kg			*7,740	6,610	*4,970	3,670	*3,780	2,430	*2,080	1,740	*1,670	*1,670	7.58 m
G.L.	kg			*6,220	*6,220	*5,540	3,460	3,680	2,330			*1,850	1,730	7.40 m
-1.5 m	kg	*4,560	*4,560	*8,400	6,170	*5,530	3,370	3,620	2,280			*2,210	1,910	6.88 m
-3.0 m	kg	*7,660	*7,660	*7,080	6,270	*4,820	3,400					*3,040	2,360	5.93 m
-4.5 m	kg			*4,330	*4,330							*2,760	*2,760	4.26 m

SK140SRLC		Boom: 4.68 m		Arm: 2.84 m		Bucket: without		Counterweight: 3,150 kg + 1,000 kg		Shoe: 600 mm		Dozer: blade up		Radius
B \ A		1.5 m		3.0 m		4.5 m		6.0 m		7.5 m		At max. reach		
7.5 m	kg					*2,360	*2,360					*2,050	*2,050	4.61 m
6.0 m	kg					*2,960	*2,960	*2,110	*2,110			*1,700	*1,700	6.12 m
4.5 m	kg					*3,280	*3,280	*3,090	2,830			*1,590	*1,590	6.99 m
3.0 m	kg			*5,680	*5,680	*4,060	*4,060	*3,400	2,730			*1,590	*1,590	7.45 m
1.5 m	kg			*7,740	7,020	*4,970	3,910	*3,780	2,600	*2,080	1,870	*1,670	*1,670	7.58 m
G.L.	kg			*6,220	*6,220	*5,540	3,690	3,890	2,490			*1,850	*1,850	7.40 m
-1.5 m	kg	*4,560	*4,560	*8,400	6,590	*5,530	3,610	3,840	2,440			*2,210	2,050	6.88 m
-3.0 m	kg	*7,660	*7,660	*7,080	6,690	*4,820	3,640					*3,040	2,530	5.93 m
-4.5 m	kg			*4,330	*4,330							*2,760	*2,760	4.26 m

SK140SRLC		Boom: 4.68 m		Arm: 2.38 m		Bucket: without		Counterweight: 3,150 kg		Shoe: 600 mm		Dozer: without		Radius
B \ A		1.5 m		3.0 m		4.5 m		6.0 m		At max. reach				
7.5 m	kg											*2,270	*2,270	3.82 m
6.0 m	kg							*3,390	*3,390			*1,800	*1,800	5.56 m
4.5 m	kg			*4,300	*4,300	*3,670	3,650	*3,380	2,280			*1,670	*1,670	6.50 m
3.0 m	kg			*6,560	6,340	*4,430	3,410	3,520	2,190			*1,670	*1,670	7.00 m
1.5 m	kg			*5,220	*5,220	*5,250	3,130	3,390	2,080			*1,760	1,600	7.13 m
G.L.	kg			*6,040	5,330	5,060	2,950	3,290	1,990			*1,980	1,630	6.94 m
-1.5 m	kg	*5,330	*5,330	*8,040	5,350	5,010	2,900	3,270	1,970			*2,440	1,820	6.38 m
-3.0 m	kg	*9,110	*9,110	*6,420	5,490	*4,440	2,970					*3,370	2,370	5.35 m











SK140SRLC		Boom: 4.68 m		Arm: 2.38 m		Bucket: without		Counterweight: 3,150 kg + 580 kg		Shoe: 600 mm		Dozer: without		Radius
B \ A		1.5 m		3.0 m		4.5 m		6.0 m		At max. reach				
7.5 m	kg											*2,270	*2,270	3.82 m
6.0 m	kg							*3,390	*3,390			*1,800	*1,800	5.56 m
4.5 m	kg			*4,300	*4,300	*3,670	*3,670	*3,380	2,510			*1,670	*1,670	6.50 m
3.0 m	kg			*6,560	*6,560	*4,430	3,730	*3,630	2,420			*1,670	*1,670	7.00 m
1.5 m	kg			*5,220	*5,220	*5,250	3,450	3,680	2,300			*1,760	*1,760	7.13 m
G.L.	kg			*6,040	5,910	5,510	3,280	3,590	2,220			*1,980	1,820	6.94 m
-1.5 m	kg	*5,330	*5,330	*8,040	5,920	*5,450	3,230	3,560	2,190			*2,440	2,030	6.38 m
-3.0 m	kg	*9,110	*9,110	*6,420	6,060	*4,440	3,300					*3,370	2,630	5.35 m











# SK140SRLC











SK140SRLC-7











# SK140SRLC Offset Boom

SK140SRLC-7

SK140SRLC		Boom: 4.68 m		Arm: 2.38 m		Bucket: without		Counterweight: 3,150 kg + 1,000 kg		Shoe: 600 mm		Dozer: without		Radius
A \ B		1.5 m		3.0 m		4.5 m		6.0 m		At max. reach				
														
7.5 m	kg											*2,270	*2,270	3.82 m
6.0 m	kg							*3,390	*3,390			*1,800	*1,800	5.56 m
4.5 m	kg			*4,300	*4,300	*3,670	*3,670	*3,380	2,670			*1,670	*1,670	6.50 m
3.0 m	kg			*6,560	*6,560	*4,430	3,970	*3,630	2,580			*1,670	*1,670	7.00 m
1.5 m	kg			*5,220	*5,220	*5,250	3,690	3,900	2,470			*1,760	*1,760	7.13 m
G.L.	kg			*6,040	*6,040	*5,650	3,510	3,800	2,380			*1,980	1,950	6.94 m
-1.5 m	kg	*5,330	*5,330	*8,040	6,340	*5,450	3,460	3,780	2,360			*2,440	2,180	6.38 m
-3.0 m	kg	*9,110	*9,110	*6,420	*6,420	*4,440	3,530					*3,370	2,820	5.35 m

SK140SRLC		Boom: 4.68 m		Arm: 2.84 m		Bucket: without		Counterweight: 3,150 kg		Shoe: 600 mm		Dozer: without		Radius	
A \ B		1.5 m		3.0 m		4.5 m		6.0 m		7.5 m		At max. reach			
															
7.5 m	kg					*2,360	*2,360					*2,050	*2,050	4.61 m	
6.0 m	kg					*2,960	*2,960	*2,110	*2,110			*1,700	*1,700	6.12 m	
4.5 m	kg					*3,280	*3,280	*3,090	2,310			*1,590	*1,590	6.99 m	
3.0 m	kg			*5,680	*5,680	*4,060	3,470	*3,400	2,210			*1,590	1,530	7.45 m	
1.5 m	kg			*7,740	5,710	*4,970	3,170	3,400	2,080	*2,080	1,470	*1,670	1,440	7.58 m	
G.L.	kg			*6,220	5,320	5,070	2,950	3,280	1,970			*1,850	1,460	7.40 m	
-1.5 m	kg	*4,560	*4,560	*8,400	5,270	4,960	2,860	3,230	1,920			*2,210	1,610	6.88 m	
-3.0 m	kg	*7,660	*7,660	*7,080	5,370	*4,820	2,890					*3,040	2,000	5.93 m	
-4.5 m	kg			*4,330	*4,330							*2,760	*2,760	4.26 m	

SK140SRLC		Boom: 4.68 m		Arm: 2.84 m		Bucket: without		Counterweight: 3,150 kg + 580 kg		Shoe: 600 mm		Dozer: without		Radius	
A \ B		1.5 m		3.0 m		4.5 m		6.0 m		7.5 m		At max. reach			
															
7.5 m	kg					*2,360	*2,360					*2,050	*2,050	4.61 m	
6.0 m	kg					*2,960	*2,960	*2,110	*2,110			*1,700	*1,700	6.12 m	
4.5 m	kg					*3,280	*3,280	*3,090	2,540			*1,590	*1,590	6.99 m	
3.0 m	kg			*5,680	*5,680	*4,060	3,790	*3,400	2,440			*1,590	*1,590	7.45 m	
1.5 m	kg			*7,740	6,280	*4,970	3,490	3,690	2,310	*2,080	1,640	*1,670	1,610	7.58 m	
G.L.	kg			*6,220	5,900	5,510	3,270	3,570	2,200			*1,850	1,640	7.40 m	
-1.5 m	kg	*4,560	*4,560	*8,400	5,840	5,410	3,190	3,520	2,150			*2,210	1,800	6.88 m	
-3.0 m	kg	*7,660	*7,660	*7,080	5,940	*4,820	3,220					*3,040	2,230	5.93 m	
-4.5 m	kg			*4,330	*4,330							*2,760	*2,760	4.26 m	

SK140SRLC		Boom: 4.68 m		Arm: 2.84 m		Bucket: without		Counterweight: 3,150 kg + 1,000 kg		Shoe: 600 mm		Dozer: without		Radius	
A \ B		1.5 m		3.0 m		4.5 m		6.0 m		7.5 m		At max. reach			
															
7.5 m	kg					*2,360	*2,360					*2,050	*2,050	4.61 m	
6.0 m	kg					*2,960	*2,960	*2,110	*2,110			*1,700	*1,700	6.12 m	
4.5 m	kg					*3,280	*3,280	*3,090	2,700			*1,590	*1,590	6.99 m	
3.0 m	kg			*5,680	*5,680	*4,060	4,030	*3,400	2,600			*1,590	*1,590	7.45 m	
1.5 m	kg			*7,740	6,700	*4,970	3,730	*3,780	2,470	*2,080	1,770	*1,670	*1,670	7.58 m	
G.L.	kg			*6,220	*6,220	*5,540	3,510	3,790	2,360			*1,850	1,760	7.40 m	
-1.5 m	kg	*4,560	*4,560	*8,400	6,260	*5,530	3,420	3,730	2,310			*2,210	1,940	6.88 m	
-3.0 m	kg	*7,660	*7,660	*7,080	6,360	*4,820	3,450					*3,040	2,400	5.93 m	
-4.5 m	kg			*4,330	*4,330							*2,760	*2,760	4.26 m	

# Lift capacities

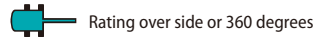
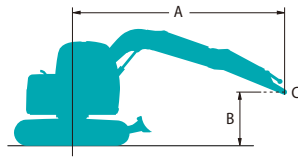

A - Reach from swing centreline to arm top

B - Arm top height above/below ground

C - Lift point

Relief valve setting: 34.3 MPa











SK140SRLC		2 Piece Boom		Arm: 2.38 m		Bucket: without		Counterweight: 3,150 kg + 580 kg		Shoe: 600 mm		Dozer: blade up		Radius
B \ A		1.5 m		3.0 m		4.5 m		6.0 m		7.5 m		At max. reach		
7.5 m	kg					*2,540	*2,540					*2,080	*2,080	4.65 m
6.0 m	kg					*3,850	*3,850	*2,360	*2,360			*1,790	*1,790	6.15 m
4.5 m	kg			*5,750	*5,750	*4,210	4,150	*3,090	2,610			*1,710	*1,710	7.01 m
3.0 m	kg	*13,300	*13,300	*7,680	6,800	*4,830	3,770	*3,190	2,450			*1,740	1,700	7.47 m
1.5 m	kg			*8,480	6,020	*5,310	3,390	*3,560	2,280	*2,490	1,630	*1,850	1,590	7.60 m
G.L.	kg	*11,660	*11,660	*3,800	*3,800	*5,270	3,170	3,530	2,150			*2,090	1,600	7.42 m
-1.5 m	kg			*6,170	5,740	*4,710	3,110	*3,460	2,100			*2,550	1,760	6.90 m
-3.0 m	kg			*4,430	*4,430	*3,540	3,160					*2,340	2,180	5.96 m











SK140SRLC		2 Piece Boom		Arm: 2.38 m		Bucket: without		Counterweight: 3,150 kg + 1,000 kg		Shoe: 600 mm		Dozer: blade up		Radius
B \ A		1.5 m		3.0 m		4.5 m		6.0 m		7.5 m		At max. reach		
7.5 m	kg					*2,540	*2,540					*2,080	*2,080	4.65 m
6.0 m	kg					*3,850	*3,850	*2,360	*2,360			*1,790	*1,790	6.15 m
4.5 m	kg			*5,750	*5,750	*4,210	*4,210	*3,090	2,770			*1,710	*1,710	7.01 m
3.0 m	kg	*13,300	*13,300	*7,680	7,220	*4,830	4,010	*3,190	2,620			*1,740	*1,740	7.47 m
1.5 m	kg			*8,480	6,440	*5,310	3,620	*3,560	2,450	*2,490	1,760	*1,850	1,720	7.60 m
G.L.	kg	*11,660	*11,660	*3,800	*3,800	*5,270	3,410	3,750	2,320			*2,090	1,730	7.42 m
-1.5 m	kg			*6,170	6,160	*4,710	3,340	*3,460	2,270			*2,550	1,890	6.90 m
-3.0 m	kg			*4,430	*4,430	*3,540	3,400					*2,340	*2,340	5.96 m











SK140SRLC		2 Piece Boom		Arm: 2.84 m		Bucket: without		Counterweight: 3,150 kg + 580 kg		Shoe: 600 mm		Dozer: blade up		Radius
B \ A		1.5 m		3.0 m		4.5 m		6.0 m		7.5 m		At max. reach		
7.5 m	kg					*3,110	*3,110					*1,920	*1,920	5.35 m
6.0 m	kg					*3,490	*3,490	*2,910	2,730			*1,690	*1,690	6.68 m
4.5 m	kg					*3,910	*3,910	*2,670	2,650			*1,620	*1,620	7.48 m
3.0 m	kg			*7,060	*7,060	*4,570	3,860	*2,800	2,490	2,720	1,710	*1,640	1,550	7.91 m
1.5 m	kg	*19,240	*19,240	*8,280	6,160	*5,160	3,450	3,700	2,300	2,630	1,630	*1,730	1,450	8.03 m
G.L.	kg	*14,700	*14,700	*4,140	*4,140	*5,290	3,180	3,530	2,150	2,550	1,560	*1,930	1,450	7.86 m
-1.5 m	kg	*3,870	*3,870	*6,520	5,640	*4,900	3,070	3,440	2,070			*2,300	1,570	7.38 m
-3.0 m	kg			*5,230	*5,230	*3,940	3,090	*2,790	2,080			*2,310	1,880	6.51 m
-4.5 m	kg	*10,550	*10,550	*5,170	*5,170	*2,020	*2,020					*1,540	*1,540	5.05 m











SK140SRLC		2 Piece Boom		Arm: 2.84 m		Bucket: without		Counterweight: 3,150 kg + 1,000 kg		Shoe: 600 mm		Dozer: blade up		Radius
B \ A		1.5 m		3.0 m		4.5 m		6.0 m		7.5 m		At max. reach		
7.5 m	kg					*3,110	*3,110					*1,920	*1,920	5.35 m
6.0 m	kg					*3,490	*3,490	*2,910	2,890			*1,690	*1,690	6.68 m
4.5 m	kg					*3,910	*3,910	*2,670	2,820			*1,620	*1,620	7.48 m
3.0 m	kg			*7,060	*7,060	*4,570	4,100	*2,800	2,650	2,880	1,840	*1,640	*1,640	7.91 m
1.5 m	kg	*19,240	*19,240	*8,280	6,580	*5,160	3,690	*3,780	2,460	2,790	1,760	*1,730	1,570	8.03 m
G.L.	kg	*14,700	*14,700	*4,140	*4,140	*5,290	3,410	3,740	2,310	2,710	1,680	*1,930	1,570	7.86 m
-1.5 m	kg	*3,870	*3,870	*6,520	6,060	*4,900	3,300	*3,580	2,230			*2,300	1,700	7.38 m
-3.0 m	kg			*5,230	*5,230	*3,940	3,320	*2,790	2,250			*2,310	2,030	6.51 m
-4.5 m	kg	*10,550	*10,550	*5,170	*5,170	*2,020	*2,020					*1,540	*1,540	5.05 m



SK140SRLC		Offset Boom	Arm: 2.20 m	Bucket: without		Counterweight: 3,150 kg + 580 kg		Shoe: 600 mm	Dozer: blade up		Radius	
B	A	1.5 m		3.0 m		4.5 m		6.0 m		At max. reach		
												
6.0 m	kg					*2,710	*2,710			*2,620	*2,620	4.52 m
4.5 m	kg			*4,070	*4,070	*3,580	*3,580			*2,510	*2,510	5.65 m
3.0 m	kg			*6,030	*6,030	*4,220	3,870	*3,550	2,450	*2,640	2,310	6.21 m
1.5 m	kg			*8,090	6,210	*4,980	3,510	3,700	2,320	*2,980	2,110	6.37 m
G.L.	kg			*7,910	5,860	*5,390	3,280	3,580	2,210	3,450	2,140	6.15 m
-1.5 m	kg	*6,240	*6,240	*7,780	5,860	*5,200	3,210			4,020	2,450	5.51 m
-3.0 m	kg			*6,030	*6,030					*4,250	3,610	4.25 m

SK140SRLC		Offset Boom	Arm: 2.20 m	Bucket: without		Counterweight: 3,150 kg + 1,000 kg		Shoe: 600 mm	Dozer: blade up		Radius	
B	A	1.5 m		3.0 m		4.5 m		6.0 m		At max. reach		
												
6.0 m	kg					*2,710	*2,710			*2,620	*2,620	4.52 m
4.5 m	kg			*4,070	*4,070	*3,580	*3,580			*2,510	*2,510	5.65 m
3.0 m	kg			*6,030	*6,030	*4,220	4,100	*3,550	2,620	*2,640	2,470	6.21 m
1.5 m	kg			*8,090	6,630	*4,980	3,750	*3,810	2,480	*2,980	2,270	6.37 m
G.L.	kg			*7,910	6,280	*5,390	3,520	3,800	2,380	3,660	2,300	6.15 m
-1.5 m	kg	*6,240	*6,240	*7,780	6,280	*5,200	3,450			*4,070	2,640	5.51 m
-3.0 m	kg			*6,030	*6,030					*4,250	3,860	4.25 m

SK140SRLC		Offset Boom	Arm: 2.50 m	Bucket: without		Counterweight: 3,150 kg + 580 kg		Shoe: 600 mm	Dozer: blade up		Radius	
B	A	1.5 m		3.0 m		4.5 m		6.0 m		At max. reach		
												
6.0 m	kg					*3,180	*3,180			*2,370	*2,370	4.88 m
4.5 m	kg					*3,320	*3,320			*2,280	*2,280	5.94 m
3.0 m	kg			*5,490	*5,490	*3,980	3,920	*3,380	2,470	*2,390	2,160	6.48 m
1.5 m	kg			*7,710	6,340	*4,790	3,540	*3,700	2,320	*2,670	1,980	6.63 m
G.L.	kg			*8,070	5,850	*5,300	3,270	3,570	2,200	3,230	2,000	6.42 m
-1.5 m	kg	*5,660	*5,660	*7,980	5,790	*5,250	3,170			3,690	2,250	5.81 m
-3.0 m	kg	*9,000	*9,000	*6,500	5,960	*4,300	3,260			*4,120	3,130	4.64 m

SK140SRLC		Offset Boom	Arm: 2.50 m	Bucket: without		Counterweight: 3,150 kg + 1,000 kg		Shoe: 600 mm	Dozer: blade up		Radius	
B	A	1.5 m		3.0 m		4.5 m		6.0 m		At max. reach		
												
6.0 m	kg					*3,180	*3,180			*2,370	*2,370	4.88 m
4.5 m	kg					*3,320	*3,320			*2,280	*2,280	5.94 m
3.0 m	kg			*5,490	*5,490	*3,980	*3,980	*3,380	2,640	*2,390	2,310	6.48 m
1.5 m	kg			*7,710	6,760	*4,790	3,780	*3,700	2,490	*2,670	2,130	6.63 m
G.L.	kg			*8,070	6,270	*5,300	3,510	3,780	2,360	*3,240	2,150	6.42 m
-1.5 m	kg	*5,660	*5,660	*7,980	6,210	*5,250	3,410			*3,870	2,420	5.81 m
-3.0 m	kg	*9,000	*9,000	*6,500	6,380	*4,300	3,490			*4,120	3,350	4.64 m

**Notes:**

- Do not attempt to lift or hold any load that is greater than these lift capacities at their specified lift point radius and heights. Weight of all accessories must be deducted from the above lift capacities.
- Lift capacities are based on machine standing on level, firm, and uniform ground. User must make allowance for job conditions such as soft or uneven ground, out of level conditions, side loads, sudden stopping of loads, hazardous conditions, experience of personnel, etc.
- Bucket pin attachment point defined as lift point.
- The above lift capacities are in compliance with ISO 10567. They do not exceed 87% of hydraulic lift capacity or 75% of tipping load. Lift capacities marked with an asterisk(\*) are limited by hydraulic capacity rather than tipping load.
- Operator should be fully acquainted with the Operator's and Maintenance Instructions before operating this machine. Rules for safe operation of equipment should be adhered to at all times.
- Lift capacities apply to only machine as originally manufactured and normally equipped by KOBELCO CONSTRUCTION MACHINERY CO., LTD.

## STANDARD EQUIPMENT

### ENGINE

- ISUZU MOTORS LIMITED 4JJ1XDDV A01 diesel engine with turbocharger and intercooler, EU Stage V compliant
- Auto Idle Stop
- Automatic engine deceleration
- Batteries (2 x 12 V - 88 Ah)
- Starting motor (24 V - 4 kW), 50 amp alternator
- Engine oil pan drain cock
- Double element air cleaner
- Refuelling pump

### CONTROL

- Working mode selector (H-mode, S-mode and ECO-mode)
- N&B piping (proportional hand controlled)  
(Not applicable for offset boom)
- Extra piping (proportional hand controlled)
- Boom, arm safety valves and overload alarm

### SWING SYSTEM & TRAVEL SYSTEM

- Swing rebound prevention system
- Straight propel system
- Two-speed travel with automatic shift down
- Sealed & lubricated track links
- 600 mm HD shoes
- Grease-type track adjusters
- Automatic swing brake
- Lower Frame Guard

### MIRRORS, LIGHTS & CAMERAS

- Rear view mirror, rear view camera, left side view camera and right side view camera
- Eagle eye view
- Three front working lights (LED)

## OPTIONAL EQUIPMENT

- Long arm
- Wide range of shoes
- Front-guard protective structure (may interfere with bucket action)
- Additional counterweight (+ 580 kg / + 1,000 kg)
- Cab top work LED lights (two lights)
- Mechanical suspension seat (Applicable for N&B piping)
- Rain visor (may interfere with bucket action)
- Floating dozer

### CAB & CONTROL

- Two control levers, pilot-operated
- Horn, electric
- Integrated left-right slide-type control box
- LED door light (interior)
- Coat hook
- Large cup holder
- Detachable two-piece floor mat
- GRAMMER\* air suspension seat with heater
- Retractable seatbelt
- Headrest
- Handrails
- Intermittent parallel wiper with double-spray washer
- Skylight
- Openable top guard (ISO 10262: 1998)
- Tinted safety glass
- Pull-type front window and removable lower front window
- Easy-to-read 10-inch LCD SCREEN multi-display monitor
- Emergency escape hammer
- Radio (AUX & Bluetooth\*)
- 12 V converter
- Hands-free telephone
- USB port
- Automatic air conditioner

The air conditioning system on this machine contains fluorinated greenhouse gas HFC-134a (GWP 1430).  
Quantity of gas 0.8 kg (CO<sub>2</sub> equivalent 1.2 t)

- Low & High flow piping (proportional hand controlled)  
(Applicable for offset boom)
- Offset boom
- Quick hitch piping
- Dozer blade (Standard for offset boom)
- Roll sun shade
- Travel alarm

Note: Standard and optional equipment may vary. Consult your KOBELCO dealer for specifics.

Bluetooth\* is a registered trademark of the Bluetooth SIG Inc.

\*GRAMMER is trademark of GRAMMER AG, registered in Germany and other countries.

**SK140SR<sub>LC</sub>**  
SK140SRLC-7

**SK140SR<sub>LC</sub>**  
SK140SRLC-7

Offset Boom

Note: This catalogue may contain attachments and optional equipment that are not available in your area. And it may contain photographs of machines with specifications that differ from those of machines sold in your areas. Please consult your nearest KOBELCO distributor for those items you require. Due to our policy of continuous product improvements all designs and specifications are subject to change without advance notice.  
Copyright by **KOBELCO CONSTRUCTION MACHINERY CO., LTD.** No part of this catalogue may be reproduced in any manner without notice.

---

**KOBELCO CONSTRUCTION MACHINERY EUROPE B.V.**

Veluwezoom 15  
1327 AE Almere  
The Netherlands  
[www.kobelco-europe.com](http://www.kobelco-europe.com)

Enquiries To: