

320E L

Hydraulic Excavator



Engine

Engine Model	Cat® C6.6 ACERT™	
Net Power – SAE J1349	114 kW	153 hp
Gross Power – SAE J1995	122 kW	164 hp

Drive

Maximum Travel Speed	5.6 km/h	3.5 mph
Maximum Drawbar Pull	205 kN	46,086 lbf

Weight

Minimum Weight	21 500 kg	47,400 lb
Maximum Weight	24 730 kg	54,450 lb

Introduction

Since its introduction in the 1990s, the 300 Series family of excavators has become the industry standard in general, quarry, and heavy construction applications. The all-new E Series and the 320E will continue that trend-setting standard.

The 320E meets today's U.S. EPA Tier 4 Interim emission standards. It is also built with several new fuel-saving and comfort-enabling features and benefits that will delight owners and operators.

If you are looking for more productivity and comfort, less fuel consumption and emissions, and easier and more sensible serviceability, you will find it in the all-new 320E and the E Series family of excavators.

Contents

Engine	3
Operator Station.....	4
Hydraulics	5
Structures & Undercarriage	6
Front Linkage	7
Work Tools.....	8
Integrated Technologies.....	10
Serviceability	11
Safety	12
Complete Customer Care.....	13
Sustainability	14
Specifications.....	15
Standard Equipment.....	30
Optional Equipment.....	31



Engine

Reduced emissions, economical and reliable performance

Cat® C6.6 ACERT™ Engine

The Cat C6.6 ACERT engine delivers more horsepower using significantly less fuel than the previous series engine.

Emissions Solution

Equipped to meet U.S. EPA Tier 4 Interim emission standards, the 320E's C6.6 ACERT engine features an aftertreatment regeneration solution that requires no operator intervention. The regeneration process automatically starts once the filtering system reaches a certain level – with no interruption to machine performance or the work process.

Biodiesel-Ready Fuel System

The C6.6 ACERT engine is equipped with an electronic-controlled high-pressure fuel system that includes an electric priming pump and three-layer fuel hoses to allow the use of biodiesel (meeting ASTM 6751 or EN 14214) up to B20 (biodiesel 20% mixture).

Cooling System

The cooling system features an air-to-air aftercooler and A/C condenser that tilt up and swing out of the way for easy servicing; the viscous fan automatically adjusts to ambient temperatures to help reduce fuel consumption and noise.

Speed and Power Control

The 320E features speed control to maintain a constant speed – regardless of load – to improve fuel economy. Three different power modes are offered: high power, standard power, and economy power. The operator can easily change between modes through the monitor or console switch to meet the needs for the job at hand – all to help manage and conserve fuel.



Operator Station

Comfort and convenience to keep people productive



Seats

The seat range includes air suspension, heated, options. All seats include a reclining back, upper and lower seat slide adjustments, and height and tilt angle adjustments to meet operator needs for comfort and productivity.

Controls

The right and left joystick consoles (1) can be adjusted to meet individual preferences, improving operator comfort and productivity during the course of a day. With the touch of a button, one-touch idle reduces engine speed to help save fuel; touch it again or move the joystick and the machine returns to normal operating level.

Monitor

The 320E is equipped with a 7" LCD (Liquid Crystal Display) monitor (2) that's 40% bigger than the previous model's with higher resolution for better visibility. In addition to an improved keypad and added functionality, it's programmable to provide information in a choice of 42 languages to support today's diverse workforce.

An "Engine Shutdown Setting" accessible through the monitor allows owners and operators to specify how long the machine should idle before shutting down the engine, which can save significant amounts of fuel.

The image of the rearview camera is displayed directly on the monitor. Up to two different camera images can be displayed on the screen.

Power Supply

Two 12-volt power supply sockets are located near key storage areas for charging electronic devices.

Storage

Storage spaces are located in the front, rear, and side consoles. A specific space near the auxiliary power supply holds MP3 players and cell phones. The drink holder accommodates large mugs with handles, and a shelf behind the seat stores large lunch or toolboxes.

Automatic Climate Control

The climate control system features five air outlets with positive filtered ventilation, which makes working in the heat and cold much more pleasant.



Hydraulics

Power to move more dirt, rock, and debris with speed and precision

Hydraulic Horsepower

Hydraulic horsepower is the actual machine power available to do work through implements and work tools. It's much more than just the engine power under the hood – it's a core strength that differentiates Cat machines from other brands.

Main Control and Auxiliary Valves

The 320E uses a high-pressure hydraulic system to tackle the toughest of work in short order. A highly efficient and simple back-to-back main control valve improves fuel consumption and allows for greater tool versatility.

Electric Boom Regeneration Valve

This valve minimizes pump flow when the boom lowers down, which helps improve fuel efficiency. It is optimized for any dial speed setting being used by the operator, which results in enhanced boom lowering speed for greater controllability.

Heavy Lift

The 320E features a heavy lift mode, which increases machine system pressure to improve lift over the front of the machine – a nice benefit in challenging situations. The system's pressure increase combined with a reduction in engine speed and heavier counterweight option give operators better control when lifting robust objects like concrete pipe and road construction barriers.

Structures & Undercarriage

Built to work in rugged environments



Frame

The upper frame includes reinforced mountings to support the Roll-Over Protective Structure (ROPS) cab; the lower frame is reinforced to increase component durability.

Undercarriage

Fixed gauge long undercarriage systems are available to support various work applications. Heavy-duty track rollers, precision-forged carrier rollers, press-fit pin master joints, and enhanced track shoe bolts improve durability and reduce the risk of machine downtime and the need and cost to replace components. Also, a segmented two-piece guiding guard is now offered to help maintain track alignment and improve performance in multiple applications.

Counterweights

Three counterweight options are available: 3.55 mt (3.9 ton), 4.6 mt (5.1 ton) for super long reach, and 5.4 mt (5.9 ton) for heavy counterweight configuration. Integrated links enable easy removal of the counterweight for maintenance or shipping.



Front Linkage

Made for high stress and long service life

Booms and Sticks

The 320E is offered with a range of booms and sticks (see list below). Each is built with internal baffle plates for added durability, and each undergoes ultrasound inspection to ensure weld quality and reliability.

Large box-section structures with thick, multi-plate fabrications, castings, and forgings are used in high-stress areas such as the boom nose, boom foot, boom cylinder, and stick foot to improve durability.

The boom nose pin retention method is a durable captured flag design. Boom durability is improved with a number of plate thickness changes. Also, the front linkage pins' inner bearing surfaces are welded, and a self-lubricated bearing is used to extend service intervals and increase uptime.

Selections

There are three basic boom options: HD, ES, and SLR. Sticks match the boom descriptions and applications below:

- **HD = Heavy Duty** – This type of boom is designed to balance reach, digging force, and bucket capacity. It covers the vast majority of applications such as digging, loading, trenching, and working with hydraulic tools.
- **ES = Extreme Service** – This type of boom is best used for demolition or extreme applications where stress loads on the boom are increased. It should be used for demanding, harsh applications like 100% rock and extensive hammer use.
- **SLR = Super Long Reach** – This front offers reaches to over 51 feet. It is well suited for ditch cleaning applications.

Work Tools

You can dig, hammer, rip, and cut with confidence.



You can extend the versatility and performance of your machine with the full lineup of Cat work tools. Each tool equips your machine to perform many different tasks found at a variety of job sites.

Couplers: Quick Tool Changes

Imagine the productivity you'll achieve with a quick coupler. Combine a robust coupler with a common work tool inventory that can be shared between same size machines and you'll get performance and flexibility on every job. The Cat Center-Lock™ pin grabber coupler features a patented locking system and highly visible lock. You can clearly see when the coupler is engaged or disengaged from the attachment.

Work Tools: Cut, Crush, Pulverize and Load

No matter your specialty, Caterpillar provides tools that are perfectly matched to get the most out of your Cat machine – quickly and efficiently. Field-installed hydraulic kits are uniquely designed to integrate any Cat work tool with your 320E.

Buckets: Dig, Move, Load

Cat buckets are designed to fill efficiently so you notice a fast, smooth cycle, which means high productivity each time you dig. Wear characteristics of general duty, heavy duty, and severe duty buckets give you solid performance in a wide variety of material abrasions. Ditch cleaning and other specialty buckets are available when needed.

GRAB, SORT, LOAD



Pro Series Hydraulic Thumbs



Stiff Link Thumbs



Contractors' Grapples



Trash Grapples

SWAP TOOLS



Center-Lock™ Pin Grabber Coupler

DIG & PACK



Ditch Cleaning and Tilt Buckets



General Duty Buckets



Heavy Duty Buckets



Severe Duty Buckets



Vibratory Plate Compactors

CUT, CRUSH, BREAK & RIP



Multi-Processors



Scrap & Demolition Shears



Secondary Pulverizers



Hydraulic Hammers



Rippers



Integrated Technologies

Solutions that make work easier and more efficient

Cat® Grade Control Depth and Slope

This optional system combines traditional machine control and guidance with standard factory-installed and calibrated components, making the system ready to go to work the moment it leaves the factory. The system utilizes internal front linkage sensors – well protected from the harsh working environment – to give operators real-time bucket tip position information through the cab monitor (1), which minimizes the need and cost for traditional grade checking and improves job site safety. It also helps the operator complete jobs in fewer cycles, which means less fuel use. Cat dealers can upgrade the system to full three-dimensional control by adding proven Cat AccuGrade™ positioning technologies, including GPS and Universal Total Station (UTS).

Cat Product Link

This optional system is deeply integrated into the machine monitoring system and is designed to help customers improve their overall fleet management effectiveness. Events and diagnostic codes as well as hours, fuel consumption, idle time, machine location, and other detailed information are transmitted to a secure web based application (2 and 3) called VisionLink™, which uses powerful tools to communicate to users and dealers.

Serviceability

Fast, easy and safe access built in

Service Doors

Wide service doors and a one-piece hood (1) provide easy access to the engine and cooling compartments. Both doors and hood feature enhanced hardware and a new screen design to help minimize debris entry.

Compartments

The pump (2), radiator (3), and air cleaner compartments provide ample access to major components and regular service items like fuel and oil filters. The fresh air filter is located on the side of the cab to make it easy to reach and replace as needed. A tilt-up ATAAC and swing-out A/C condenser make cleaning cores a much easier task to perform.

Other Service Enhancements

The water separator with water level sensor has a primary fuel filter element located in the pump compartment near ground level.

The electric priming pump is mounted before the primary filter base and is easy to service compared to a traditional hand-priming pump.

The fuel tank features a remote drain cock located in the pump compartment to make it easy to remove water and sediment during maintenance.

The engine oil check gauge is situated in front of the engine compartment for easy access, and a uniquely designed drain cock helps prevent spills.

Hydraulic lash adjusters automatically adjust valve opening and closing events to help reduce fuel consumption and engine noise. They also eliminate the need for a valve lash, which reduces maintenance for the customer.

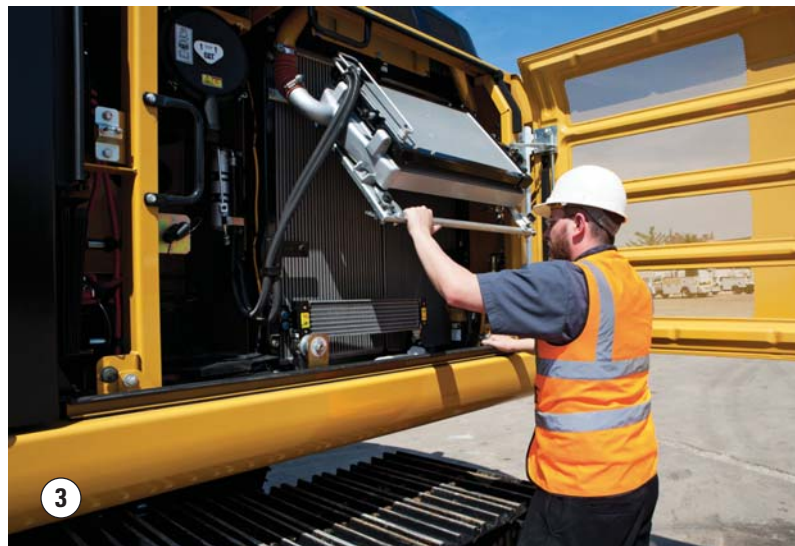
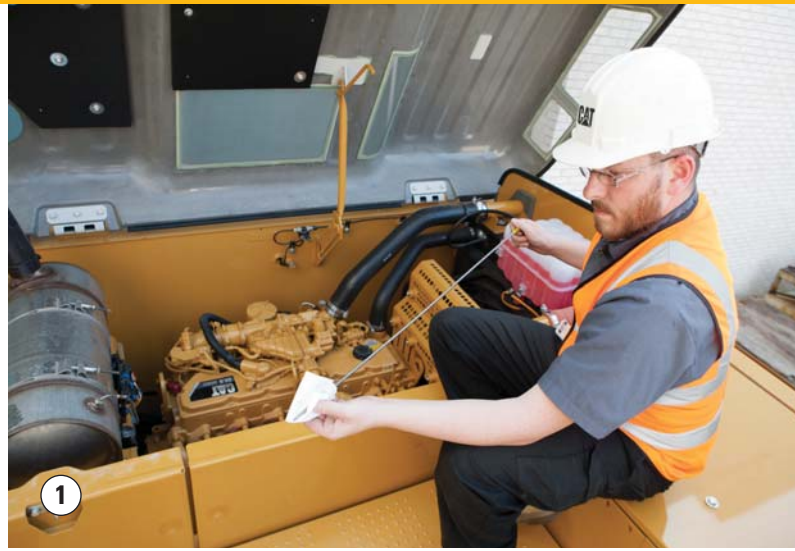

Safety

Features to help protect people



ROPS Cab

The ROPS-certified cab allows a Falling Object Guard Structure (FOGS) to be bolted directly to it.

Sound Proofing

Improved sealing and cab roof lining lower noise levels by 5 dB inside the cab – a significant benefit to operators.

Anti-Skid Plates

The surface of the upper structure and the top of the storage box area are covered with anti-skid plates to help prevent service personnel and operators from slipping during maintenance.

Steps, Hand and Guard Rails

Steps (1) on the track frame and storage box along with extended hand (2) and guard rails to the upper deck enable operators to securely work on the machine.

Time Delay Cab and Boom Lights

After the engine start key has been turned to the “OFF” position, lights will be illuminated to enhance visibility. The time delay can vary from 0 to 90 seconds, which can be set through the monitor.

High Intensity Discharge (HID) Lights

Cab lights can be upgraded to HID for greater visibility.

Windows

Two windshield options are available: The 70/30 split configuration features an upper window equipped with handles on the top and both sides so the operator can slide it to store in the ceiling. The lower window is removable and can be stored on the left wall of the cab shell.

The large skylight provides great overhead visibility, excellent natural lighting, and good ventilation. The skylight can be opened completely to become an emergency exit.

Monitor Warning System

The machine’s advanced diagnostic system features a buzzer in the monitor to communicate to operators critical events like full filters or low hydraulic fluid levels so they can take immediate action.

Rearview Camera

The standard rearview camera (3) is housed in the counterweight. The image projects through the cab monitor to give the operator a clear view of what is behind the machine.



Complete Customer Care

Service you can count on

Product Support

Cat dealers utilize a worldwide parts network to maximize your machines' uptime. Plus they can help you save money with Cat remanufactured components.

Machine Selection

What are the job requirements and machine attachments? What production is needed? Your Cat dealer can provide recommendations to help you make the right machine choices.

Purchase

Consider financing options and day-to-day operating costs. Look at dealer services that can be included in the machine's cost to yield lower owning and operating costs over time.

Customer Support Agreements

Cat dealers offer a variety of customer support agreements and work with you to develop a plan to meet your specific needs. These plans can cover the entire machine, including attachments, to help protect your investment.

Operation

Improving operating techniques can boost your profits. Your Cat dealer has videos, literature, and other ideas to help you increase productivity. Caterpillar also offers simulators and certified operator training to help maximize the return on your investment.

Replacement

Repair, rebuild, or replace? Your Cat dealer can help you evaluate the cost involved so you can make the best choice for your business.



Sustainability

Generations ahead in every way

- The C6.6 ACERT engine, along with the Cat Clean Emissions Module (CEM), meets U.S. Tier 4 Interim emission standards.
- The 320E has the flexibility of running on either ultra-low-sulfur diesel (ULSD) fuel with 15 ppm of sulfur or less or biodiesel (B20) fuel blended with ULSD that meets ASTM 6751 or EN 14214 standards.
- Even when operating in high horsepower and high production applications, the 320E performs a similar amount of work as the previous D Series model with significantly reduced fuel consumption.
- The 320E is quieter inside and out, which benefits operators and the surrounding environment.
- An overfill indicator rises when the fuel tank is full to help the operator avoid spilling.
- The QuickEvac™ option ensures fast, easy, and secure changing of engine and hydraulic oil.
- The 320E is built to be rebuilt with major structures and components capable of being remanufactured to reduce waste and replacement costs.
- An eco-friendly engine oil filter eliminates the need for painted metal cans and aluminum top plates. The cartridge-style spin-on housing enables the internal filter to be separated and replaced; the used internal element can be incinerated to help reduce waste.
- The 320E is an efficient, productive machine that's designed to conserve our natural resources for generations ahead.

320E L Hydraulic Excavator Specifications

Engine

Engine Model	Cat® C6.6 ACERT™	
Net Power – SAE J1349	114 kW	153 hp
Gross Power – SAE J1995	122 kW	164 hp
Bore	105 mm	4.1 in
Stroke	127 mm	5.0 in
Displacement	6.6 L	403 in ³

Weights

Minimum Operating Weight*	21 500 kg	47,400 lb
Maximum Operating Weight**	24 730 kg	54,450 lb

*HD 5.7 m (18'8") boom, HD 3.9 m (12'10") stick, 3.55 mt (3.9 ton) counterweight, 1.19 m³ (1.56 yd³), 600 mm (24") shoes.

**HD 5.7 m (18'8") boom, ES 2.9 m (9'6") stick, 5.4 mt (5.9 ton) counterweight (heavy counterweight configuration), 1.19 m³ (1.56 yd³), 790 mm (31") shoes.

Hydraulic System

Main System – Maximum Flow (Total)	428 L/min	113.1 gal/min
Maximum Pressure – Equipment		
Heavy Lift	38 000 kPa	5,511 psi
Normal	35 000 kPa	5,076 psi
Maximum Pressure – Travel	35 000 kPa	5,076 psi
Maximum Pressure – Swing	25 000 kPa	3,626 psi
Pilot System – Maximum Flow	24.3 L/min	6.4 gal/min
Pilot System – Maximum Pressure	3920 kPa	569 psi
Boom Cylinder – Bore	120 mm	4.7 in
Boom Cylinder – Stroke	1260 mm	49.6 in
Stick Cylinder – Bore	140 mm	5.5 in
Stick Cylinder – Stroke	1504 mm	59.2 in
B1 Bucket Cylinder – Bore	120 mm	4.7 in
B1 Bucket Cylinder – Stroke	1104 mm	43.5 in

Drive

Maximum Travel Speed	5.6 km/h	3.5 mph
Maximum Drawbar Pull	205 kN	46,086 lbf

Swing Mechanism

Swing Speed	11.2 rpm
Swing Torque	61.8 kN·m 45,581 lb-ft

Service Refill Capacities

Fuel Tank Capacity	410 L	108.3 gal
Cooling System	30 L	7.9 gal
Engine Oil (with filter)	23 L	6.1 gal
Swing Drive	8 L	2.1 gal
Final Drive (each)	8 L	2.1 gal
Hydraulic System (including tank)	260 L	68.7 gal
Hydraulic Tank	143 L	37.8 gal

Track

Number of Shoes (each side)	
Long Undercarriage	49 pieces
Number of Track Rollers (each side)	
Long Undercarriage	8 pieces
Number of Carrier Rollers (each side)	
Long Undercarriage	2 pieces

Sound Performance

Operator Noise (Closed) – ISO 6396	71 dB(A)
Spectator Noise – ISO 6395	103 dB(A)

- When properly installed and maintained, the cab offered by Caterpillar, when tested with doors and windows closed according to ANSI/SAE J1166 OCT98, meets OSHA and MSHA requirements for operator sound exposure limits in effect at time of manufacture.
- Hearing protection may be needed when operating with an open operator station and cab (when not properly maintained or doors/windows open) for extended periods or in noisy environment.

Standards

Brakes	ISO 10265 2008
Cab/FOGS	ISO 10262 1998
Cab/ROPS	ISO 12117-2 2008

320E L Hydraulic Excavator Specifications

Dimensions

All dimensions are approximate.

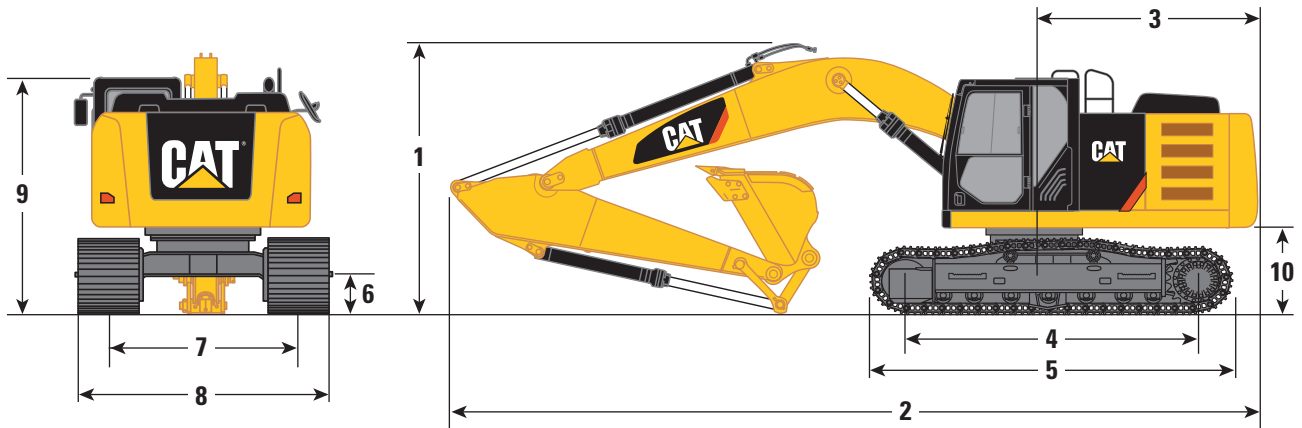

Stick	Heavy Duty and Extreme Service Booms 5.7 m (18'8")		Super Long Reach Boom 8.85 m (29'0")
	3.9B1 (12'10")*	2.9B1 (9'6")**	Super Long Reach 6.28 m (20'6")***
	mm (ft)	mm (ft)	mm (ft)
1 Shipping Height†	3740 (12'3")	3130 (10'4")	3180 (10'4")
Shipping Height with Guard Rail	3240 (10'8")	3240 (10'8")	3240 (10'8")
Shipping Height with Top Guard	3150 (10'3")	3150 (10'3")	3150 (10'3")
2 Shipping Length	9340 (30'8")	9540 (31'4")	12 750 (41'10")
3 Tail Swing Radius	2830 (9'3")	2830 (9'3")	2830 (9'3")
4 Length to Center of Rollers	3650 (12'0")	3650 (12'0")	3650 (12'0")
5 Track Length	4460 (14'6")	4460 (14'6")	4460 (14'6")
6 Ground Clearance	450 (1'6")	450 (1'6")	450 (1'6")
7 Track Gauge	2380 (7'10")	2380 (7'10")	2380 (7'10")
8 Transport Width			
600 mm (24") Shoes	2980 (9'9")	2980 (9'9")	2980 (9'9")
790 mm (31") Shoes	3170 (10'5")	3170 (10'5")	3170 (10'5")
9 Cab Height	2960 (9'9")	2960 (9'9")	2960 (9'9")
Cab Height with Top Guard	3150 (10'3")	3150 (10'3")	3150 (10'3")
10 Counterweight Clearance††	1020 (3'4")	1020 (3'4")	1020 (3'4")

*Cat 900 mm (36"), 0.81 m³ (1.06 yd³) GD bucket with 1557 mm (5'1") tip radius.

**Cat 1200 mm (48"), 1.19 m³ (1.56 yd³) HD bucket with 1571 mm (5'2") tip radius.

***Cat 1100 mm (44"), 0.61 m³ (0.8 yd³) ditch cleaning bucket with 1092 mm (3'7") tip radius.

†Including shoe lug height without guard rail.

††Without shoe lug height.

Working Ranges

All dimensions are approximate.

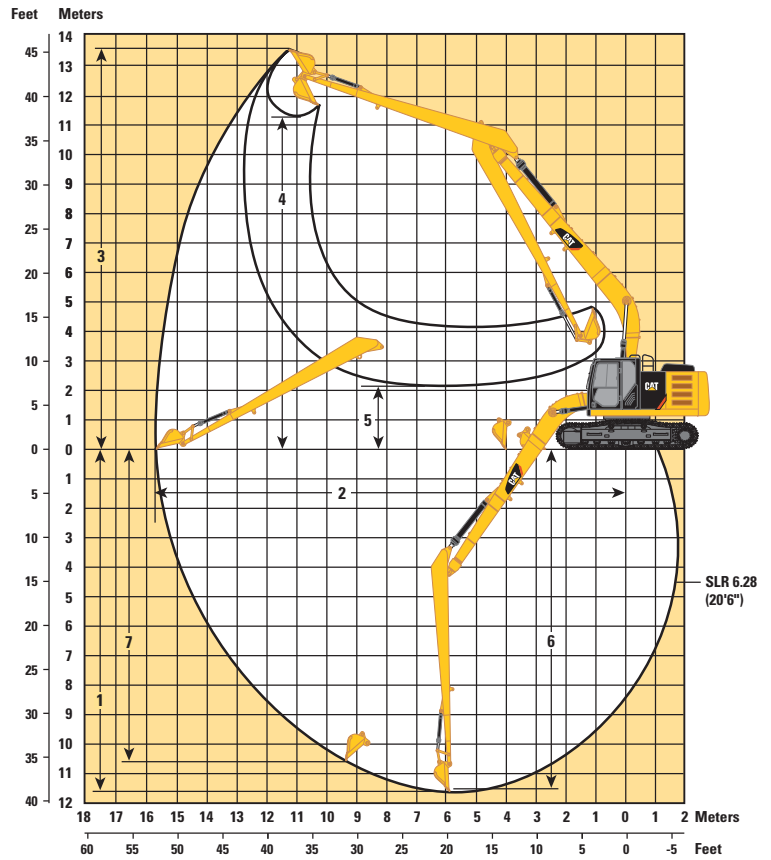
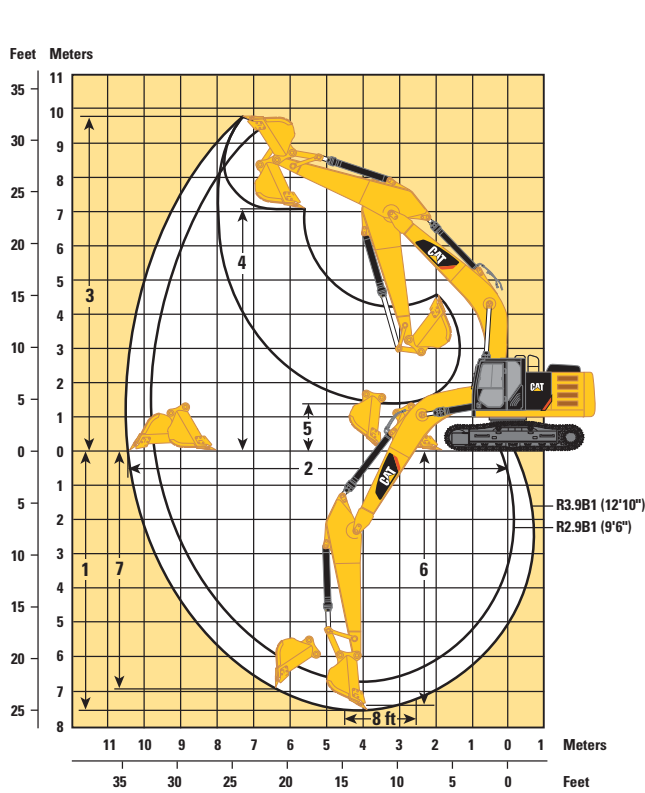

Heavy Duty and Extreme Service Booms 5.7 m (18'8")

Super Long Reach Boom 8.85 m (29'0")

Stick	3.9B1 (12'10")*	2.9B1 (9'6")**	Super Long Reach 6.28 m (20'6")***
	mm (ft)	mm (ft)	mm (ft)
1 Maximum Digging Depth	7580 (24'10")	6720 (22'1")	11 690 (38'4")
2 Maximum Reach at Ground Level	10 680 (35'0")	9860 (30'9")	15 720 (51'6")
3 Maximum Cutting Height	9890 (32'4")	9370 (30'7")	13 590 (44'6")
4 Maximum Loading Height	7030 (23'0")	6490 (21'4")	11 290 (37'0")
5 Minimum Loading Height	1310 (4'4")	2170 (7'1")	2090 (6'9")
6 Maximum Depth Cut for 2440 mm (8'0") Level Bottom	7440 (24'4")	6550 (21'6")	11 590 (38'0")
7 Maximum Vertical Wall Digging Depth	6910 (22'7")	5060 (16'7")	10 670 (35'0")

*Cat 900 mm (36"), 0.81 m³ (1.06 yd³) GD bucket with 1557 mm (5'1") tip radius.

**Cat 1200 mm (48"), 1.19 m³ (1.56 yd³) HD bucket with 1571 mm (5'2") tip radius.

***Cat 1100 mm (44"), 0.61 m³ (0.8 yd³) ditch cleaning bucket with 1092 mm (3'7") tip radius.

320E L Hydraulic Excavator Specifications

Major Component Weights

	kg	lb
Base Machine (with boom cylinder, without counterweight, front linkage and track)	11 300	24,920
Long Undercarriage	7850	17,300
Counterweight		
3.55 mt (3.9 ton) Standard	3550	7,830
4.6 mt (5.1 ton) Super Long Reach	4600	10,140
5.4 mt (5.9 ton) Heavy	5400	11,910
Boom (includes lines, pins and stick cylinder)		
Boom HD – 5.7 m (18'8")	1720	3,790
Boom ES – 5.7 m (18'8")	2010	4,430
Boom HD for CGC – 5.7 m (18'8")	1730	3,810
Boom ES for CGC – 5.7 m (18'8")	2020	4,450
Super Long Reach – 8.85 m (29'0")	2400	5,290
Stick (includes lines, pins and bucket cylinder)		
3.9B1 (12'10") HD	930	2,060
2.9B1 (9'6") HD	680	1,510
2.9B1 (9'6") ES	840	1,850
2.9B1 (9'6") HD for CGC	690	1,530
2.9B1 (9'6") ES for CGC	850	1,870
Super Long Reach	1240	2,740
Track Shoe (Long/per two tracks)		
600 mm (24") Triple Grouser	2700	5,940
790 mm (31") Triple Grouser	3360	7,410
790 mm (31") Triple Grouser HD	3800	8,370
Quick Coupler		
Center-Lock 252	420	920
Buckets		
B1 900 mm (36") GD 347-6707 SAE 0.8 m ³ (1.06 yd ³)	650	1,420
B1 1200 mm (48") HD 347-6731 SAE 1.19 m ³ (1.56 yd ³)	930	2,050

All weights are rounded up to nearest 10 kg and lb except for quick coupler and buckets. Kg and lb were rounded up separately so some of the kg and lb do not match. Base machine includes 75 kg (165 lb) operator weight, 90% fuel weight, and undercarriage with center guard.

Operating Weight and Ground Pressure

	320E L			
	790 mm (31") Triple Grouser Shoes		600 mm (24") Triple Grouser Shoes	
	kg (lb)	kPa (psi)	kg (lb)	kPa (psi)
Boom HD – 5.7 m (18'8")				
3.9B1 (12'10") HD	22 200 (48,940)	35.0 (5.08)	21 500 (47,400)	44.7 (6.48)
2.9B1 (9'6") HD	22 200 (48,940)	35.1 (5.10)	21 600 (47,620)	44.9 (6.51)
2.9B1 (9'6") ES	22 400 (49,380)	35.4 (5.13)	21 700 (47,840)	45.2 (6.56)
2.9B1 (9'6") ES with Heavy Counterweight	24 700 (54,450)	38.9 (5.64)		
Boom ES – 5.7 m (18'8")				
3.9B1 (12'10") HD	22 500 (49,600)	35.5 (5.15)	21 800 (48,060)	45.4 (6.58)
2.9B1 (9'6") HD	22 600 (49,820)	35.7 (5.18)	21 900 (48,280)	45.6 (6.61)
2.9B1 (9'6") ES	22 700 (50,040)	35.9 (5.21)	22 100 (48,720)	45.9 (6.66)
Super Long Reach Boom – 8.85 m (29'0")				
6.28 m (20'6") SLR	23 500 (51,810)	37.1 (5.38)	22 800 (50,270)	47.4 (6.87)

Bucket and Stick Forces

Stick	Heavy Duty and Extreme Service Booms 5.7 m (18'8")		Super Long Reach Boom 8.85 m (29'0")
	3.9B1 (12'10")	2.9B1 (9'6")	Super Long Reach 6.28 m (20'6")
B1 – Family Bucket	kN (lbf)	kN (lbf)	kN (lbf)
General Duty			
Bucket Digging Force (SAE)	125.9 (28,300)	125.9 (28,300)	51.2 (11,500)
Stick Digging Force (SAE)	87.8 (19,700)	103.9 (23,400)	35.8 (8,000)
Heavy Duty			
Bucket Digging Force (SAE)	124.4 (28,000)	133.5 (30,000)	
Stick Digging Force (SAE)	87.6 (19,700)	103.2 (23,200)	
Severe Duty			
Bucket Digging Force (SAE)	124.4 (28,000)	133.5 (30,000)	
Stick Digging Force (SAE)	87.6 (19,700)	103.2 (23,200)	

320E L Hydraulic Excavator Specifications

HD Boom Lift Capacities



Load Point Height



Load at Maximum Reach



Load Radius Over Front



Load Radius Over Side

Boom – 5.7 m (18'8")

















Counterweight – 3.55 mt (3.9 t)

Bucket – None

Stick – 3.9B1 (12'10")

Shoes – 790 mm (31") triple grouser

Heavy Lift Mode On

	1.5 m/5.0 ft		3.0 m/10.0 ft		4.5 m/15.0 ft		6.0 m/20.0 ft		7.5 m/25.0 ft		9.0 m/30.0 ft				m ft		
																	
7.5 m 25.0 ft	kg lb														*3000 *6,600	*3000 *6,600	7.32 23.69
6.0 m 20.0 ft	kg lb									*4550 *9,600	3800 8,150				*2800 *6,150	*2800 *6,150	8.29 27.05
4.5 m 15.0 ft	kg lb									*4800 *10,550	3750 8,000				*2750 *6,050	*2750 *6,050	8.91 29.17
3.0 m 10.0 ft	kg lb					*7150 *15,450	*7150 *15,450	*5950 *12,850	5050 10,900	*5300 *11,550	3600 7,750	*3850 *7,150	2700 5,750		*2800 *6,150	2550 5,650	9.25 30.31
1.5 m 5.0 ft	kg lb			*9800 *23,300	*9800 *23,300	*9300 *20,050	7250 15,600	*7000 *15,150	4800 10,300	5450 11,750	3450 7,400	4150 *8,500	2600 5,600		*2950 *6,450	2450 5,400	9.33 30.60
Ground Line	kg lb			*8050 *18,450	*8050 *18,450	*10 850 *23,400	6800 14,650	7400 15,950	4550 9,750	5300 11,400	3300 7,150	4100 *7,250	2550 5,500		*3200 *7,050	2500 5,450	9.16 30.05
-1.5 m -5.0 ft	kg lb	*6050 *13,500	*6050 *13,500	*10 400 *23,550	*10 400 *23,550	*11 500 24,700	6600 14,200	7250 15,600	4400 9,450	5250 11,250	3250 6,950				*3650 *8,000	2650 5,800	8.73 28.61
-3.0 m -10.0 ft	kg lb	*9400 *21,050	*9400 *21,050	*14 400 *32,750	12 700 27,200	*11 350 *24,550	6550 14,150	7200 15,500	4350 9,400	5250 11,250	3250 6,950				*4450 *9,850	3000 6,600	8.00 26.15
-4.5 m -15.0 ft	kg lb	*13 650 *30,750	*13 650 *30,750	*14 750 *31,700	12 950 27,750	*10 250 *22,000	6700 14,400	7300 15,750	4450 9,600						6050 *13,450	3750 8,350	6.86 22.30
-6.0 m	kg					*7250	7000								*6400	6200	4.91

Boom – 5.7 m (18'8")















Counterweight – 3.55 mt (3.9 t)

Bucket – None

Stick – 2.9B1 (9'6")

Shoes – 790 mm (31") triple grouser

Heavy Lift Mode On

	1.5 m/5.0 ft		3.0 m/10.0 ft		4.5 m/15.0 ft		6.0 m/20.0 ft		7.5 m/25.0 ft				m ft	
														
7.5 m 25.0 ft	kg lb							*4950 *4950				*4300 *9,500	*4300 *9,500	6.15 19.78
6.0 m 20.0 ft	kg lb							*5450 *12,000	5400 11,600			*3950 *8,750	3950 *8,750	7.28 23.71
4.5 m 15.0 ft	kg lb							*6000 *13,050	5250 11,300	*5650 12,300	3750 8,000	*3900 *8,550	3350 7,450	7.98 26.10
3.0 m 10.0 ft	kg lb					*8750 *18,850	7650 16,500	*6900 *14,950	5050 10,850	5650 12,100	3650 7,800	*4000 *8,750	3050 6,750	8.35 27.38
1.5 m 5.0 ft	kg lb					*10 600 *22,900	7150 15,450	7700 16,550	4800 10,350	5500 11,850	3500 7,550	*4200 *9,250	2950 6,500	8.44 27.70
Ground Line	kg lb			*6600 *15,150	*6600 *15,150	*11 650 *25,200	6900 14,850	7500 16,100	4650 10,000	5400 11,650	3450 7,400	*4650 *10,250	3000 6,600	8.26 27.09
-1.5 m -5.0 ft	kg lb	*7050 *15,750	*7050 *15,750	*11 400 *25,850	*11 400 *25,850	11 750 25,150	6800 14,650	7400 15,950	4550 9,800	5400 11,600	3400 7,350	5150 11,300	3250 7,150	7.78 25.48
-3.0 m -10.0 ft	kg lb	*12 100 *27,100	*12 100 *27,100	*15 600 *33,750	13 250 28,350	*11 000 *23,800	6850 14,750	7450 16,000	4600 9,900			6050 13,450	3800 8,450	6.94 22.67
-4.5 m -15.0 ft	kg lb			*12 450 *26,650	*12 450 *26,650	*8950 *19,050	7050 15,200					*6800 *14,900	5250 11,750	5.60 18.08

*Indicates that the load is limited by hydraulic lifting capacity rather than tipping load. The above loads are in compliance with hydraulic excavator lift capacity standard ISO 10567:2007. They do not exceed 87% of hydraulic lifting capacity or 75% of tipping load. Weight of all lifting accessories must be deducted from the above lifting capacities. Lifting capacities are based on the machine standing on a firm, uniform supporting surface. The use of a work tool attachment point to handle/lift objects, could affect the machine lift performance.

Always refer to the appropriate Operation and Maintenance Manual for specific product information.

ES Boom Lift Capacities



Load Point Height



Load at Maximum Reach



Load Radius Over Front



Load Radius Over Side

Boom – 5.7 m (18'8")

Counterweight – 3.55 mt (3.9 t)

Bucket – None

Stick – 2.9B1 (9'6")

Shoes – 790 mm (31") triple grouser

Heavy Lift Mode On

 7.5 m 25.0 ft kg lb	1.5 m/5.0 ft		3.0 m/10.0 ft		4.5 m/15.0 ft		6.0 m/20.0 ft		7.5 m/25.0 ft		 m ft				
	 kg lb	 kg lb	 kg lb	 kg lb	 kg lb	 kg lb	 kg lb	 kg lb	 kg lb	 kg lb	 kg lb	 kg lb	m ft		
								*4900	*4900			*4200	*4200	6.15	
								*5300	*5300			*3900	3800	7.28	
								*11,650	11,450			*8,600	8,500	23.71	
								*5850	5150	*5450	3600	*3850	3250	7.98	
								*12,700	11,100	*12,000	7,700	*8,400	7,150	26.10	
								*6700	4900	5500	3500	*3900	2950	8.35	
								*14,500	10,500	11,850	7,500	*8,600	6,450	27.38	
								7550	4650	5350	3350	*4150	2800	8.44	
								*22,250	14,950	16,200	9,950	*9,150	6,200	27.70	
								6950	7300	4450	5250	4600	2850	8.26	
								*11,300	15,700	9,550	11,300	7,000	10,100	6,250	27.09
								6600	7200	4350	5250	5000	3100	7.78	
								14,250	15,500	9,350	11,250	6,950	10,950	6,800	25.48
								6550	7250	4400			5900	3650	6.94
								24,550	14,050	15,600			13,050	8,050	22.67
								6600	7250	4400			5900	3650	6.94
								14,150	15,600	9,450			13,050	8,050	22.67
								6800					5050	5.60	
								*18,400	14,700			*14,350	11,350	18.08	

*Indicates that the load is limited by hydraulic lifting capacity rather than tipping load. The above loads are in compliance with hydraulic excavator lift capacity standard ISO 10567:2007. They do not exceed 87% of hydraulic lifting capacity or 75% of tipping load. Weight of all lifting accessories must be deducted from the above lifting capacities. Lifting capacities are based on the machine standing on a firm, uniform supporting surface. The use of a work tool attachment point to handle/lift objects, could affect the machine lift performance.

Always refer to the appropriate Operation and Maintenance Manual for specific product information.

320E L Hydraulic Excavator Specifications

HD Boom Lift Capacities



Load Point Height



Load at Maximum Reach



Load Radius Over Front



Load Radius Over Side

Boom – 5.7 m (18'8")















Counterweight – 5.4 mt (5.9 t)

Bucket – None

Stick – 2.9B1 (9'6") ES

Shoes – 790 mm (31") triple grouser

Heavy Lift Mode On

	1.5 m/5.0 ft		3.0 m/10.0 ft		4.5 m/15.0 ft		6.0 m/20.0 ft		7.5 m/25.0 ft				m ft		
															
7.5 m 25.0 ft	kg lb						*4900	*4900			*4200	*4200	6.15 19.78		
6.0 m 20.0 ft	kg lb						*5900	*5900			*3900	*3900	7.28 23.71		
4.5 m 15.0 ft	kg lb						*6500	6350	*6100	4550	*3850	*3850	7.98 26.10		
3.0 m 10.0 ft	kg lb				*9500	9250	*7450	6100	*6550	4400	*3900	3750	8.35 27.38		
1.5 m 5.0 ft	kg lb				*11 500	8750	*8500	5850	6550	4300	*4150	3650	8.44 27.70		
Ground Line	kg lb			*6550	*15,000	*15,000	*12 650	8450	8950	5700	6450	4200	*4600	3700	8.26 27.09
-1.5 m -5.0 ft	kg lb	*7000	*7000	*11 350	*11 350	*12 750	8400	8850	5600	6450	4200	*5400	4000	7.78 25.48	
-3.0 m -10.0 ft	kg lb	*12 000	*12 000	*16 950	16 250	*11 950	8450	*8900	5650			*7000	4700	6.94 22.67	
-4.5 m -15.0 ft	kg lb			*13 550	*13 550	*9750	8650					*7350	6400	5.60 18.08	

*Indicates that the load is limited by hydraulic lifting capacity rather than tipping load. The above loads are in compliance with hydraulic excavator lift capacity standard ISO 10567:2007. They do not exceed 87% of hydraulic lifting capacity or 75% of tipping load. Weight of all lifting accessories must be deducted from the above lifting capacities. Lifting capacities are based on the machine standing on a firm, uniform supporting surface. The use of a work tool attachment point to handle/lift objects, could affect the machine lift performance.

Always refer to the appropriate Operation and Maintenance Manual for specific product information.

Super Long Reach Boom Lift Capacities



Load Point Height



Load at Maximum Reach



Load Radius Over Front



Load Radius Over Side

Boom – 8.85 m (29'0")

Counterweight – 4.6 mt (5.1 t)

Bucket – None

Stick – 6.28 m (20'6") Super Long Reach

Shoes – 790 mm (31") triple grouser

	1.5 m/5.0 ft		3.0 m/10.0 ft		4.5 m/15.0 ft		6.0 m/20.0 ft		7.5 m/25.0 ft				m ft	
	kg lb	kg lb	kg lb	kg lb	kg lb	kg lb	kg lb	kg lb	kg lb	kg lb	kg lb	kg lb		
12.0 m 40.0 ft												*1250 *2,800	*1250 *2,800	10.35 33.31
10.5 m 35.0 ft												*1200 *2,600	*1200 *2,600	11.66 37.83
9.0 m 30.0 ft												*1150 *2,450	*1150 *2,450	12.66 41.25
7.5 m 25.0 ft												*1100 *2,400	*1100 *2,400	13.41 43.83
6.0 m 20.0 ft												*1100 *2,400	*1100 *2,400	13.96 45.71
4.5 m 15.0 ft												*1100 *2,400	*1100 *2,400	14.34 46.99
3.0 m 10.0 ft			*4700 *11,850	*4700 *11,850	*5950 *12,700	*5950 *12,700	*4350 *9,400	*4350 *9,400	*3550 *7,650	*3550 *7,650	*1150 *2,500	*1150 *2,500	14.54 47.71	
1.5 m 5.0 ft					*6750 *15,750	6500 14,000	*5150 *11,050	4500 9,700	*4000 *8,700	3300 7,150	*1200 *2,600	1100 2,400	14.60 47.89	
Ground Line			*2000 *4,550	*2000 *4,550	*4650 *10,700	*4650 *10,700	*5750 *12,400	4000 8,650	*4450 *9,550	3000 6,500	*1250 *2,750	1100 2,350	14.49 47.54	
-1.5 m -5.0 ft	kg lb	*2050 *4,550	*2050 *4,550	*2700 *6,050	*2700 *6,050	*4650 *10,500	*4650 *10,500	*6100 *13,250	3750 8,000	*4700 *10,200	2800 6,000	*1350 *2,950	1100 2,400	14.22 46.65
-3.0 m -10.0 ft	kg lb	*2850 *6,350	*2850 *6,350	*3500 *7,850	*3500 *7,850	*5200 *11,750	*5200 *11,500	*6250 *13,550	3600 7,700	4700 10,150	2650 5,700	*1500 *3,300	1150 2,500	13.79 45.19
-4.5 m -15.0 ft	kg lb	*3650 *8,150	*3650 *8,150	*4400 *9,900	*4400 *9,900	*6050 *13,700	5400 11,550	*6250 *13,450	3550 7,600	4650 10,000	2600 5,600	*1700 *3,750	1200 2,700	13.17 43.10
-6.0 m -20.0 ft	kg lb	*4550 *10,100	*4550 *10,100	*5400 *12,150	*5400 *12,150	*7200 *16,350	5500 11,850	*6000 *12,900	3600 7,700	4650 10,050	2600 5,650	*2000 *4,450	1350 3,000	12.34 40.27
-7.5 m -25.0 ft	kg lb	*5500 *12,250	*5500 *12,250	*6550 *14,800	*6550 *14,800	*7100 *15,250	5700 12,300	*5500 *11,850	3700 7,950	*4450 *9,500	2700 5,800	*2500 *5,650	1600 3,550	11.24 36.55
-9.0 m -30.0 ft	kg lb			*7950 *16,950	*7950 *16,950	*5950 *12,700	*5950 *12,700	*4700 *10,050	3900 8,400	*3800 *8,050	2850 6,150	*2600 *5,700	2050 4,600	9.79 31.60

*Indicates that the load is limited by hydraulic lifting capacity rather than tipping load. The above loads are in compliance with hydraulic excavator lift capacity standard ISO 10567:2007. They do not exceed 87% of hydraulic lifting capacity or 75% of tipping load. Weight of all lifting accessories must be deducted from the above lifting capacities. Lifting capacities are based on the machine standing on a firm, uniform supporting surface. The use of a work tool attachment point to handle/lift objects, could affect the machine lift performance.

Always refer to the appropriate Operation and Maintenance Manual for specific product information.

Work Tool Offering Guide*

Boom	5.7 m (18'8")	
Stick	3.9 m (12'10")	2.9 m (9'6")
Hydraulic Hammer	H115Es H120Es H130Es**	H115Es H120Es H130Es
Multi-Processor		MP15**
Pulverizer	P215**	P215
Mobile Scrap and Demolition Shear	S325B*** S340B***	S320B** S325B*** S340B***
Compactor (Vibratory Plate)	CVP110	CVP110
Contractors' Grapple	G120B-G130B	G120B-G130B
Trash Grapple		
Thumbs		
Rakes		
Center-Lock Pin Grabber Coupler		
Dedicated Quick Coupler		

These work tools are available for the 320E.
Consult your Cat dealer for proper match.

*Matches are dependent on excavator configurations. Consult your Cat dealer for proper work tool match.

**Pin-on only.

***Boom-mount.

320E L Hydraulic Excavator Specifications

Bucket Specifications and Compatibility

Without Quick Coupler									320E L			320E L	
	Linkage	Width		Capacity		Weight		Fill	Boom (HD)			Boom (ES)	
		mm	in	m ³	yd ³	kg	lb	%	3.9 HD (12'10")	2.9 HD (9'6")	2.9 ES (9'6")	3.9 HD (12'10")	2.9 ES (9'6")
General Duty (GDC)	B	600	24	0.55	0.72	618	1,363	100%	●	●	●	●	●
	B	750	30	0.75	0.98	710	1,566	100%	●	●	●	●	●
	B	900	36	0.95	1.24	786	1,733	100%	⊙	●	●	⊖	●
	B	1050	42	1.16	1.52	847	1,867	100%	○	⊙	⊙	○	⊙
	B	1200	48	1.38	1.80	925	2,038	100%	◇	⊖	⊖	◇	○
	B	1350	54	1.59	2.08	1002	2,209	100%	X	○**	○	X	○
Heavy Duty (HD)	B	600	24	0.46	0.61	649	1,430	100%	●	●	●	●	●
	B	750	30	0.64	0.84	747	1,647	100%	●	●	●	●	●
	B	900	36	0.81	1.06	825	1,818	100%	●	●	●	⊙	●
	B	1050	42	1.00	1.31	879	1,937	100%	⊖	●	●	⊖	⊙
	B	1200	48	1.19	1.56	970	2,138	100%	○	⊙	⊖	○	⊖
	B	1350	54*	1.38	1.81	1051	2,316	100%	X	⊖**	○	X	○
Severe Duty (SD)	B	600	24	0.46	0.61	693	1,527	90%	●	●	●	●	●
	B	750	30	0.64	0.84	801	1,765	90%	●	●	●	●	●
	B	900	36	0.81	1.06	887	1,955	90%	●	●	●	●	●
	B	1050	42	1.00	1.31	962	2,121	90%	⊖	●	●	⊖	●
	B	1200	48	1.19	1.56	1051	2,316	90%	○	⊙	⊙	○	⊖
Super Long Reach	SLR	813	32	0.46	0.60	341	751	100%					
	SLR	1143	45	0.61	0.80	289	637	100%					
Maximum load pin-on (payload + bucket)								kg	2480	3070	2950	2410	2870
								lb	5,466	6,766	6,502	5,312	6,325

Maximum Material Density:

- 2100 kg/m³ (3,500 lb/yd³)
- ⊙ 1800 kg/m³ (3,000 lb/yd³)
- ⊖ 1500 kg/m³ (2,500 lb/yd³)
- 1200 kg/m³ (2,000 lb/yd³)
- ◇ 900 kg/m³ (1,500 lb/yd³)
- X Not recommended

The above loads are in compliance with hydraulic excavator standard EN474, they do not exceed 87% of hydraulic lifting capacity or 75% of tipping capacity with front linkage fully extended at ground line with bucket curled.

Capacity based on ISO 7451.

Bucket weight with General Duty tips.

*This bucket might reduce boom structure life.

**For light dirt loading applications only. Consult your dealer to understand your application before using this bucket in combination with this stick.

Caterpillar recommends using appropriate work tools to maximize the value customers receive from our products. Use of work tools, including buckets, which are outside of Caterpillar's recommendations or specifications for weight, dimensions, flows, pressures, etc. may result in less-than-optimal performance, including but not limited to reductions in production, stability, reliability, and component durability. Improper use of a work tool resulting in sweeping, prying, twisting and/or catching of heavy loads will reduce the life of the boom and stick.

Bucket Specifications and Compatibility

Without Quick Coupler									320E L**	320E L
	Linkage	Width		Capacity		Weight		Fill	Boom (HD)	SLR
		mm	in	m ³	yd ³	kg	lb	%	2.9 ES (9'6")	6.28 m (20'6")
General Duty (GDC)	B	600	24	0.55	0.72	618	1,363	100%	●	
	B	750	30	0.75	0.98	710	1,566	100%	●	
	B	900	36	0.95	1.24	786	1,733	100%	●	
	B	1050	42	1.16	1.52	847	1,867	100%	●	
	B	1200	48	1.38	1.80	925	2,038	100%	●	
	B	1350	54	1.59	2.08	1002	2,209	100%	⊙	
Heavy Duty (HD)	B	600	24	0.46	0.61	649	1,430	100%	●	
	B	750	30	0.64	0.84	747	1,647	100%	●	
	B	900	36	0.81	1.06	825	1,818	100%	●	
	B	1050	42	1.00	1.31	879	1,937	100%	●	
	B	1200	48	1.19	1.56	970	2,138	100%	●	
	B	1350	54*	1.38	1.81	1051	2,316	100%	●	
Severe Duty (SD)	B	600	24	0.46	0.61	693	1,527	90%	●	
	B	750	30	0.64	0.84	801	1,765	90%	●	
	B	900	36	0.81	1.06	887	1,955	90%	●	
	B	1050	42	1.00	1.31	962	2,121	90%	●	
	B	1200	48	1.19	1.56	1051	2,316	90%	●	
Super Long Reach	SLR	813	32	0.46	0.60	341	751	100%		○
	SLR	1143	45	0.61	0.80	289	637	100%		◇
Maximum load pin-on (payload + bucket)								kg	3820	915
								lb	8,419	2,017

Maximum Material Density:

- 2100 kg/m³ (3,500 lb/yd³)
- ⊙ 1800 kg/m³ (3,000 lb/yd³)
- ⊖ 1500 kg/m³ (2,500 lb/yd³)
- 1200 kg/m³ (2,000 lb/yd³)
- ◇ 900 kg/m³ (1,500 lb/yd³)

The above loads are in compliance with hydraulic excavator standard EN474, they do not exceed 87% of hydraulic lifting capacity or 75% of tipping capacity with front linkage fully extended at ground line with bucket curled.

Capacity based on ISO 7451.

Bucket weight with General Duty tips.

*This bucket might reduce boom structure life.

**Heavy counterweight configuration with 5.4 mt (5.9 ton) counterweight.

Caterpillar recommends using appropriate work tools to maximize the value customers receive from our products. Use of work tools, including buckets, which are outside of Caterpillar's recommendations or specifications for weight, dimensions, flows, pressures, etc. may result in less-than-optimal performance, including but not limited to reductions in production, stability, reliability, and component durability. Improper use of a work tool resulting in sweeping, prying, twisting and/or catching of heavy loads will reduce the life of the boom and stick.

320E L Hydraulic Excavator Specifications

Bucket Specifications and Compatibility

With Center Lock Coupler									320E L			320E L	
	Linkage	Width		Capacity		Weight		Fill	Boom (HD)			Boom (ES)	
		mm	in	m ³	yd ³	kg	lb	%	3.9 HD (12'10")**	2.9 HD (9'6")	2.9 ES (9'6")	3.9 HD (12'10")**	2.9 ES (9'6")
General Duty (GDC)	B	600	24	0.55	0.72	618	1,363	100%	●	●	●	●	●
	B	750	30	0.75	0.98	710	1,566	100%	⊙	●	●	⊙	●
	B	900	36	0.95	1.24	786	1,733	100%	○	⊙	⊙	○	⊙
	B	1050	42	1.16	1.52	847	1,867	100%	◇	⊖	⊖	◇	○
	B	1200	48	1.38	1.80	925	2,038	100%	X	○	○	X	◇
	B	1350	54	1.59	2.08	1002	2,209	100%	X	◇	◇	X	◇
Heavy Duty (HD)	B	600	24	0.46	0.61	649	1,430	100%	●	●	●	●	●
	B	750	30	0.64	0.84	747	1,647	100%	●	●	●	⊙	●
	B	900	36	0.81	1.06	825	1,818	100%	⊖	●	●	⊖	●
	B	1050	42	1.00	1.31	879	1,937	100%	○	⊙	⊖	◇	⊖
	B	1200	48	1.19	1.56	970	2,138	100%	◇	○	○	◇	○
	B	1350	54*	1.38	1.81	1051	2,316	100%	X	○	◇	X	◇
Severe Duty (SD)	B	600	24	0.46	0.61	693	1,527	90%	●	●	●	●	●
	B	750	30	0.64	0.84	801	1,765	90%	●	●	●	●	●
	B	900	36	0.81	1.06	887	1,955	90%	⊖	●	●	⊖	●
	B	1050	42	1.00	1.31	962	2,121	90%	○	⊙	⊙	○	⊖
	B	1200	48	1.19	1.56	1051	2,316	90%	◇	⊖	○	◇	○
	B	1200	48	1.19	1.56	1000	2,204	90%	◇	⊖	⊖	◇	○
Maximum load with coupler (payload + bucket)								kg	2070	2660	2540	2000	2460
								lb	4,563	5,863	5,599	4,409	5,422

Maximum Material Density:

- 2100 kg/m³ (3,500 lb/yd³)
- ⊙ 1800 kg/m³ (3,000 lb/yd³)
- ⊖ 1500 kg/m³ (2,500 lb/yd³)
- 1200 kg/m³ (2,000 lb/yd³)
- ◇ 900 kg/m³ (1,500 lb/yd³)
- X Not recommended

The above loads are in compliance with hydraulic excavator standard EN474, they do not exceed 87% of hydraulic lifting capacity or 75% of tipping capacity with front linkage fully extended at ground line with bucket curled.

Capacity based on ISO 7451.

Bucket weight with General Duty tips.

*This bucket might reduce boom structure life.

**Auxiliary hydraulic lines available from Cat Work Tools.

Caterpillar recommends using appropriate work tools to maximize the value customers receive from our products. Use of work tools, including buckets, which are outside of Caterpillar's recommendations or specifications for weight, dimensions, flows, pressures, etc. may result in less-than-optimal performance, including but not limited to reductions in production, stability, reliability, and component durability. Improper use of a work tool resulting in sweeping, prying, twisting and/or catching of heavy loads will reduce the life of the boom and stick.

Bucket Specifications and Compatibility

With Center Lock Coupler									320E L**	320E L
	Linkage	Width		Capacity		Weight		Fill	Boom (HD)	SLR
		mm	in	m ³	yd ³	kg	lb	%	2.9 ES (9'6")	6.28 m (20'6")
General Duty (GDC)	B	600	24	0.55	0.72	618	1,363	100%	●	
	B	750	30	0.75	0.98	710	1,566	100%	●	
	B	900	36	0.95	1.24	786	1,733	100%	●	
	B	1050	42	1.16	1.52	847	1,867	100%	●	
	B	1200	48	1.38	1.80	925	2,038	100%	⊙	
	B	1350	54	1.59	2.08	1002	2,209	100%	⊖	
Heavy Duty (HD)	B	600	24	0.46	0.61	649	1,430	100%	●	
	B	750	30	0.64	0.84	747	1,647	100%	●	
	B	900	36	0.81	1.06	825	1,818	100%	●	
	B	1050	42	1.00	1.31	879	1,937	100%	●	
	B	1200	48	1.19	1.56	970	2,138	100%	●	
	B	1350	54*	1.38	1.81	1051	2,316	100%	⊖	
Severe Duty (SD)	B	600	24	0.46	0.61	693	1,527	90%	●	
	B	750	30	0.64	0.84	801	1,765	90%	●	
	B	900	36	0.81	1.06	887	1,955	90%	●	
	B	1050	42	1.00	1.31	962	2,121	90%	●	
	B	1200	48	1.19	1.56	1051	2,316	90%	●	
	B	1200	48	1.19	1.56	1000	2,204	90%	●	
Maximum load with coupler (payload + bucket)								kg	3410	
								lb	7,516	

The above loads are in compliance with hydraulic excavator standard EN474, they do not exceed 87% of hydraulic lifting capacity or 75% of tipping capacity with front linkage fully extended at ground line with bucket curled.

Capacity based on ISO 7451.

Bucket weight with General Duty tips.

*This bucket might reduce boom structure life.

**Heavy counterweight configuration with 5.4 mt (5.9 ton) counterweight.

Maximum Material Density:

- 2100 kg/m³ (3,500 lb/yd³)
- ⊙ 1800 kg/m³ (3,000 lb/yd³)
- ⊖ 1500 kg/m³ (2,500 lb/yd³)
- 1200 kg/m³ (2,000 lb/yd³)

Caterpillar recommends using appropriate work tools to maximize the value customers receive from our products. Use of work tools, including buckets, which are outside of Caterpillar's recommendations or specifications for weight, dimensions, flows, pressures, etc. may result in less-than-optimal performance, including but not limited to reductions in production, stability, reliability, and component durability. Improper use of a work tool resulting in sweeping, prying, twisting and/or catching of heavy loads will reduce the life of the boom and stick.

320E L Standard Equipment

Standard Equipment

Standard equipment may vary. Consult your Cat dealer for details.

ENGINE

- C6.6 diesel engine
- Biodiesel capable
- EPA Tier 4 Interim
- 2300 m (7,500 ft) altitude capability
- Electric priming pump
- Automatic engine speed control
- Economy, standard and high power modes
- Two-speed travel
- Side-by-side cooling system (tilt-up ATAAC, swing-out A/C condenser)
- Radial seal air filter
- Primary filter with water separator and water separator indicator switch
- Starting kit, cold weather, -18° C (0° F)
- Screen fuel filter in fuel lines
- Primary fuel filter
- Secondary fuel filter
- Quick drains, engine and hydraulic oil (QuickEvac)

HYDRAULIC SYSTEM

- Regeneration circuit for boom and stick
- Reverse swing dampening valve
- Automatic swing parking brake
- High-performance hydraulic return filter
- Capability of installing HP stackable valve and medium and QC valve
- Capability of installing additional auxiliary pump and circuit
- Capability of installing boom lowering control device and stick lowering check valve
- Capability of installing Cat Bio hydraulic oil
- Fine swing control

CAB

- Pressurized operator station with positive filtration
- Mirror package
- Sliding upper door window (left-hand cab door)
- Glass-breaking safety hammer
- Removable lower windshield with in cab storage bracket
- Coat hook
- Beverage holder
- Literature holder
- AM/FM radio
- Radio with MP3 auxiliary audio port
- Two 12V stereo speakers
- Storage shelf suitable for lunch or toolbox
- Color LCD display with warning, filter/fluid change, and working hour information
- Adjustable armrest
- Height adjustable joystick consoles
- Neutral lever (lock out) for all controls
- Travel control pedals with removable hand levers
- Capability of installing two additional pedals
- Two power outlets, 10 amp (total)
- Laminated glass front upper window and tempered other windows

UNDERCARRIAGE

- Grease Lubricated Track GLT2, resin seal
- Towing eye on base frame

ELECTRICAL

- 80 amp alternator
- Circuit breaker
- Capability to electrically connect a beacon

LIGHTS

- Boom light with time delay
- Exterior lights integrated into storage box

SECURITY

- Cat one key security system
- Door locks
- Cap locks on fuel and hydraulic tanks
- Lockable external tool/storage box
- Signaling/warning horn
- Secondary engine shutoff switch
- Openable skylight for emergency exit
- Rearview camera
- Travel alarm

TECHNOLOGY

- Product Link

Optional Equipment

Optional equipment may vary. Consult your Cat dealer for details.

ENGINE

- Starting kit, cold weather, -32° C (-26° F)
- Jump start receptacle
- Radiator screen
- Block heater (jacket water heater)

HYDRAULIC SYSTEM

- Control pattern quick-changer, two way
- Additional circuit
- Boom and stick lines
- High-pressure line
- Medium-pressure line
- Cat quick coupler line – high-pressure capable
- Electronic Control device, 1/2P, one-way circuit
- Electronic Control device (Common), 1/2P, common circuit
- Electronic Control device, 1P, two-way circuit
- Boom lowering and stick lowering control device

CAB

- Cab hatch emergency exit
- Seat, high-back air suspension with heater
- Seat, high-back mechanical suspension
- Sunscreen
- Windshield wiper, upper and lower with washer
- Air pre-filter
- Left foot switch
- Left pedal
- Straight travel pedal

UNDERCARRIAGE

- 600 mm (24") triple grouser shoes
- 790 mm (31") triple grouser shoes
- Guard, full length for long FG undercarriage
- Guard, heavy-duty bottom
- Center track guiding guard
- Segmented (2 piece) track guiding guard
- HD track roller

COUNTERWEIGHT

- 3.55 mt (3.9 t) with lifting eye
- 4.6 mt (5.1 t) with lifting eye
- 5.4 mt (5.9 t) with lifting eye

FRONT LINKAGE

- Quick coupler
- Bucket linkage, B1 family with lifting eye
- 5.7 m (18'8") heavy duty and extreme service booms
- 8.85 m (29'0") SLR boom
- 2.9 m (9'6") stick
- 3.9 m (12'10") stick
- 6.28 m (20'6") SLR stick

LIGHTS

- Working lights, cab mounted with time delay
- HID lights, cab mounted with time delay
- Halogen boom lights

SECURITY

- FOGS, bolt-on
- Side rubber bumper
- Guard, vandalism
- Cat MSS (anti-theft device)

TECHNOLOGY

- Cat Grade Control Depth and Slope

For more complete information on Cat products, dealer services, and industry solutions, visit us on the web at www.cat.com

© 2013 Caterpillar Inc.
All rights reserved

Materials and specifications are subject to change without notice. Featured machines in photos may include additional equipment. See your Cat dealer for available options.

CAT, CATERPILLAR, SAFETY.CAT.COM, their respective logos, "Caterpillar Yellow" and the "Power Edge" trade dress, as well as corporate and product identity used herein, are trademarks of Caterpillar and may not be used without permission.

AEHQ6441-02 (05-2013)
Replaces AEHQ6441-01
(Americas)

